

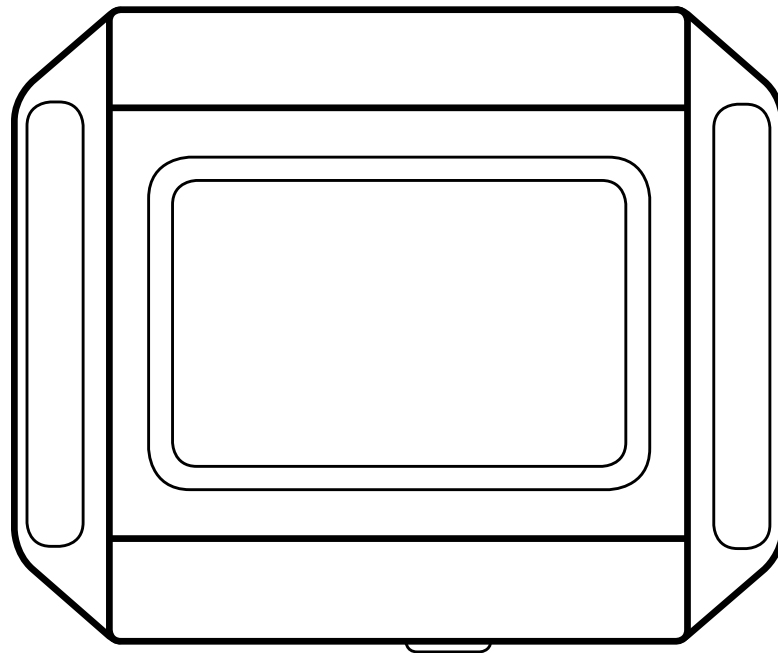

# PRODUCT MANUAL

BU100, BU400, BU800

[beamlabs.io](https://beamlabs.io)



# TABLE OF CONTENTS

Congratulations on purchasing your beamUP garage door opener. It will provide you with many years of security, safety and convenience. This installation and owner's manual contains complete instructions for installing and operating your garage door opener.

For warranty registration  
[beamlabs.io/warranty](https://beamlabs.io/warranty)

Carton Contents.....	1	Enabling/Disabling Motion Sensing	
Before You Begin.....	2	Security Lighting .....	20
Preparation + Tools Needed.....	3	Connecting Standard Door Control.....	21
Rail Assembly.....	4	Before We Start Programming The Opener .....	22
Rail and Power Head Assembly .....	5	Travel Limit Adjustment – UP Limit .....	23
Trolley and Pulley Assembly.....	6	Travel Limit Adjustment – DOWN Limit.....	24
Installing Chain and Cable .....	7	Setting the Force.....	25
Installing Belt .....	9	Final Adjustments and Testing.....	26
Attaching Sprocket Cover.....	11	Handheld Remote Control .....	27
Mounting Header Bracket.....	12	Wireless Keypad .....	28
Attaching Rail and Mounting Door Bracket .....	13	beamUP Smart Garage Door Controller.....	29
Mounting Power Head to Ceiling.....	14	Using your Garage Door Opener .....	30
Attaching Door Arms.....	15	Troubleshooting.....	35
Emergency Release Handle.....	16	Maintenance.....	37
Connecting Photo Eye Safety System .....	17	Warranty .....	38
Connecting Power and Aligning Photo		Spare Parts .....	42
Eye Safety System.....	18	Opener Assembly Parts.....	43
Connecting Deluxe Door Control.....	19		

# CARTON CONTENTS

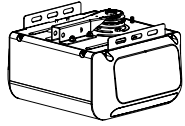

Power Head

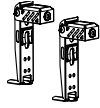

Photo Eye  
Safety System



Header Bracket



Door Bracket

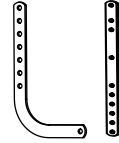

Door Arms

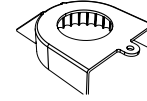

Sprocket Cover

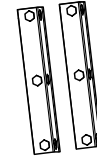

Hanging Bracket



Trolley Shaft/  
Belt Assembly  
(BU800)



Trolley Shaft/  
Cable Assembly  
(BU100 & BU400)



Rail

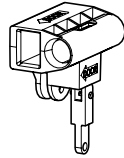

Trolley

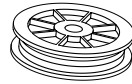

Pulley



1 x Master Link

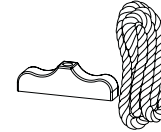

Emergency  
Release Handle

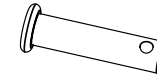

5 x Clevis Pins  
2 x 5/16" x 1"  
2 x 5/16" x 1-3/8"  
1 x 3/8" x 1-3/4"



5 x Hitch Pins



7 x Flange Nut

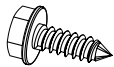

2 x Self-Threading  
Screws  
1/4" x 5/8"

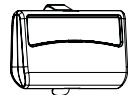

Single Button  
Remote  
(BU100)

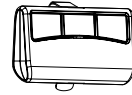

Three Button  
Remote  
(BU400 & BU800)



Standard  
Door Control  
(BU100)



Deluxe  
Door Control  
(BU400 & BU800)



Wireless Keypad  
(BU800)

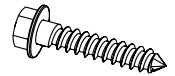

6 x Lag Screws  
5/16" - 1/1/2"

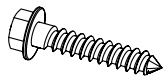

4 x Screws  
#12 x 1-1/4"

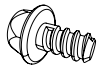

1 x Self-Threading  
Screw  
#8-18 x 5/16"

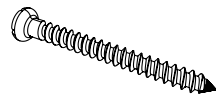

6 x Screws  
#6 x 1-3/8"

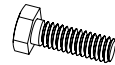

6 x Bolts  
5/16" - 18 x 1"

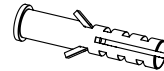

6 x Anchors

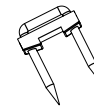

Insulated Staples

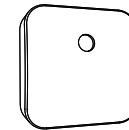

Controller  
(BU400 & BU800)

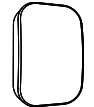

Wireless Door  
Sensor  
(BU400 & BU800)

## BEFORE YOU BEGIN

Measure door height.

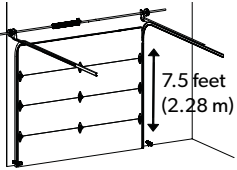

If over 7.5 feet (2.28 m), rail extension kit will be needed.

Check mounting locations.  
Are additional reinforcement material needed?



See page 3

Check your toolbox. Do you have all the tools needed?

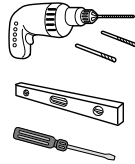

See page 3



# WARNING



Child can be pinned under automatic garage door.  
**Death or serious injury can result.**

- Never let child walk or run under moving door.
- Never let child use door opener controls.
- Always keep moving door in sight.
- If person is pinned, push control button or use emergency release.
- Test door opener monthly:  
Refer to your owner's manual.  
Place a 1 1/2" / 50mm object (or 2 x 4" / 100 x 50mm laid flat) on floor.  
If door fails to reverse on contact, adjust opener.  
If opener still fails to reverse door, repair or replace opener.

Do not remove or paint over this label.  
Mount wall control out of child's reach  
(at least 5 feet / 1.5m above floor).

Place next to wall control. GUST11A-2

## SAFETY INSTRUCTIONS

### **WARNING**

To reduce the risk of severe injury or death:

1. READ AND FOLLOW ALL INSTALLATION INSTRUCTIONS.
2. Install only on a properly balanced garage door. An improperly balanced door has the potential to inflict severe injury. Have a qualified service person make repairs to cables, spring assemblies, and other hardware before installing the opener.
3. Remove all ropes and remove or make inoperative all locks connected to the garage door before installing opener.
4. Where possible, install the door opener 7 feet (2.13 m) or more above the floor. For products having an emergency release, mount the emergency release within reach, but at least 6 feet above the floor and avoiding contact with vehicles to avoid accidental release.
5. Do not connect the opener to source of power until instructed to do so.
6. Locate the door control button: (a) within sight of door, (b) at a minimum height of 5 feet so small children are not able to reach it, and (c) away from all moving parts of the door.
7. Install the Entrapment Warning Label next to the wall-mount control button in a prominent location.
8. After installing the opener, the door must reverse when it contacts a 1-1/2 inch (3.8 cm) high object (or a 2x4 board) laid flat on the floor.
9. NEVER try to remove, loosen, move, or adjust garage door, cables, pulleys, brackets, and door springs. All are under EXTREME tension.
10. To reduce the risk of injuries to persons – use this operator only with residential sectional garage doors. Only enable the unattended operation feature when installed with a sectional door. The Smart Door Controller should be used only on sectional doors and with garage door openers made after 1993 with a photo eye safety system.

# PREPARE GARAGE DOOR FOR INSTALLATION TOOLS NEEDED

**DO NOT REUSE PARTS AND WIRING FROM AN OLD OPENER!!!**

**BEFORE beginning installation:**

1. Disable locks and disengage trolley from current opener.
2. Perform the following door test to ensure your door is balanced and in good working condition.

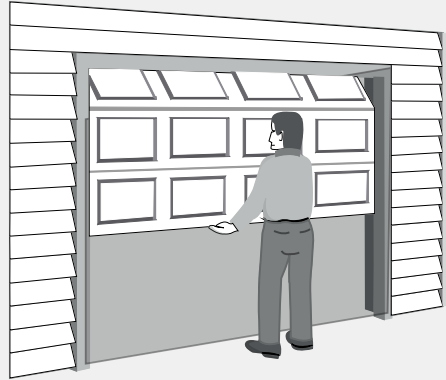

**Make sure garage door is fully closed before you start the installation**

**To test your garage door:**

1. Raise and lower the door to check if there is any sticking or binding.
2. Check for loose hinges, damaged rollers, frayed cables and damaged or broken springs.
3. Lift the door approximately halfway and release. The door should stay at that point under proper spring tension.

Call a qualified garage door service technician if your door binds, sticks or is unbalanced.

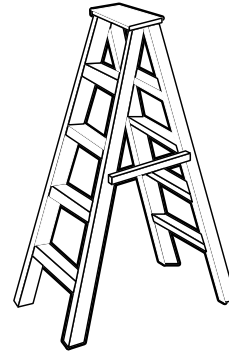

Step Ladder

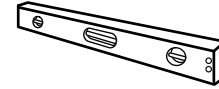

Level



Pencil

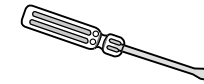

Screwdriver

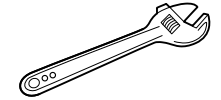

Adjustable Wrench

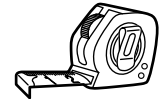

Tape Measure



Pliers

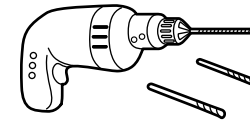

Drill 3/16" and 5/16" Drill Bits

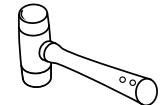

Rubber Mallet

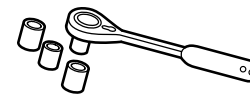

Ratchet with 1/4", 7/16" and 1/2" sockets

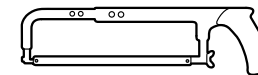

Hack Saw

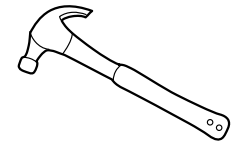

Hammer

# RAIL ASSEMBLY

Look in the box for:

Rail – Header Segment



Rail – Middle Segments x3

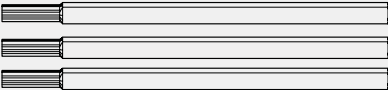

Rail – End Segment



Tools needed:

Rubber Mallet

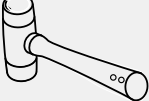

## CAUTION

To prevent INJURY from pinching, keep hands and fingers away from joints when assembling the rail.

Connect rails starting with the rail header segment. To apply additional force tap gently on the end of the connected rail segments with a rubber mallet or on padded flooring.

1

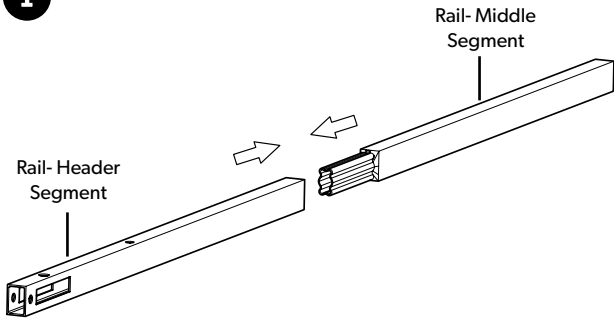

Securely connected by applying force

✓  
Right

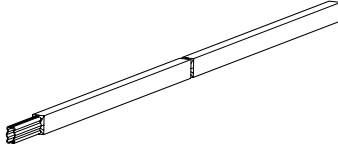

✗  
Wrong

Loosely connected

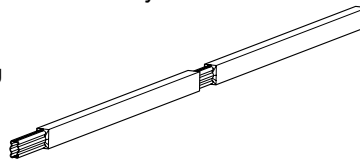

2

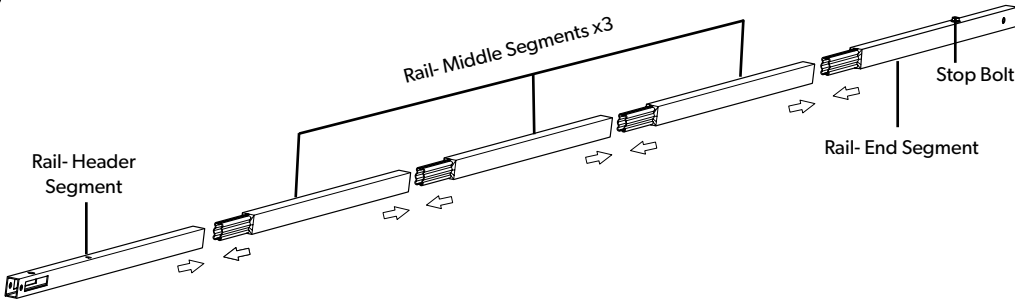

# RAIL AND POWER HEAD ASSEMBLY

Look in the box for:

Power Head

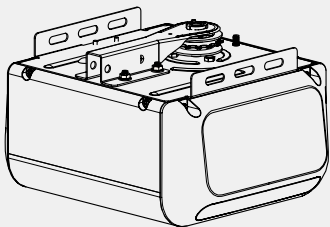

Opener Carton

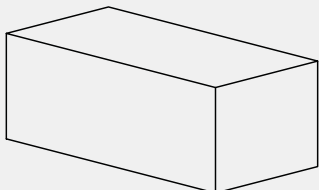

Clevis Pin  
5/16" x 1-3/8"

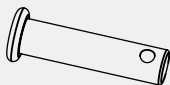

Hitch Pin



Use garage door opener carton to assemble rail to power head. Use packing material as protective base for power head.

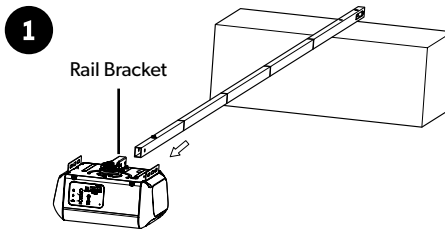

Insert rail-end segment into bracket as shown.

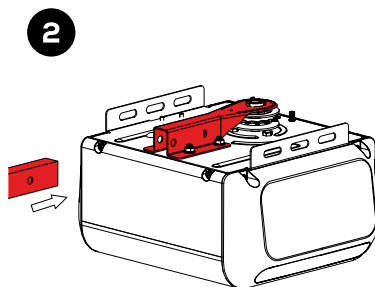

Insert clevis pin into rail bracket as shown.

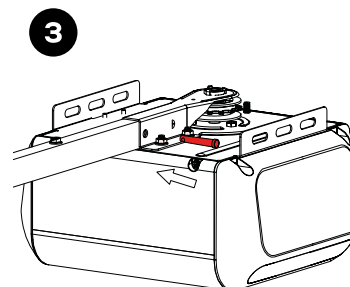

Insert hitch pin into clevis pin as shown.

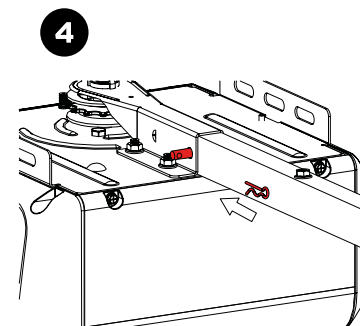

# TROLLEY AND PULLEY ASSEMBLY

Look in the box for:

Trolley

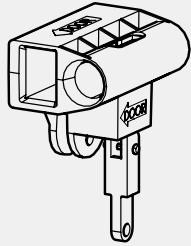

Pulley

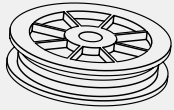

Clevis Pin  
3/8" x 1-3/4"

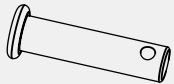

Hitch Pin



Slide trolley onto the rail. Make sure the arrow on the trolley points toward the door.

1

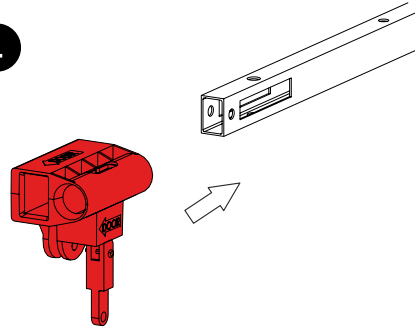

2

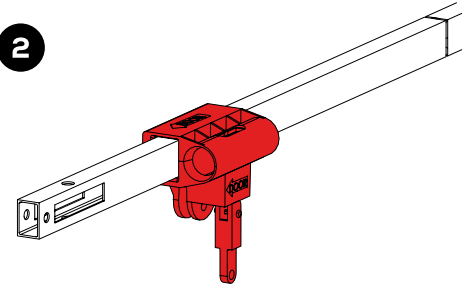

Insert pulley into the pulley slot.

3

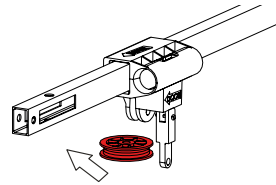

Insert clevis pin through rail hole and pulley.

4

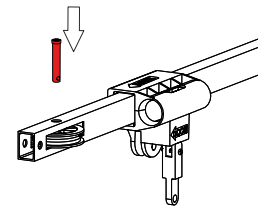

Insert hitch pin into clevis pin.

5

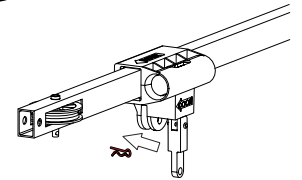



# INSTALLING CABLE AND CHAIN (BU100, BU400)

Look in the box for:

Trolley Shaft/Chain Assembly

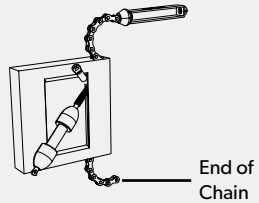

Master Link



## ⚠ WARNING



To prevent SERIOUS INJURY:

- DO NOT connect power until instructed.
- Keep hands and fingers clear from sprocket during operation.
- Wear gloves when installing chain and cable.
- Keep hands and fingers away from joints and possible sharp edges.

Loosely attach trolley shaft with chain connector. 5 complete turns will be sufficient.



Align end of chain around sprocket and extend chain past chassis, approximately 7" (17.8 cm). Sprocket teeth must engage the chain.

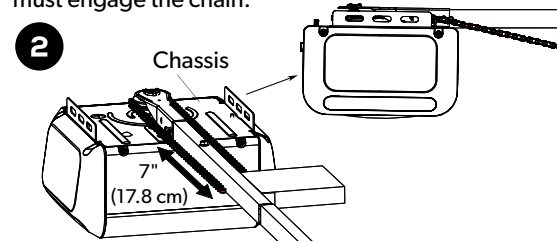

Pull chain with box along the rail towards trolley and then remove box.

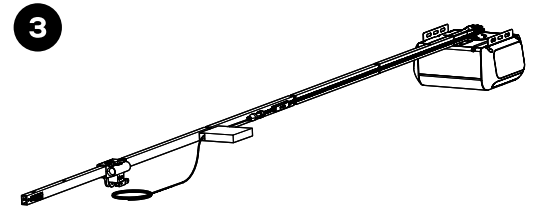

Insert cable through circular hole in trolley. Pull cable through pulley slot and toward power head.

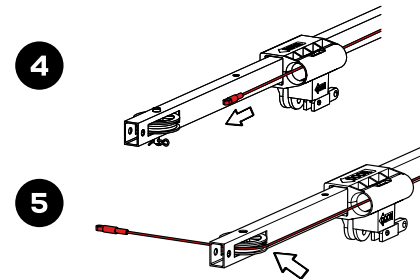

Pull trolley lock lever down to unlock. Insert trolley shaft through the trolley and pull lever back up.

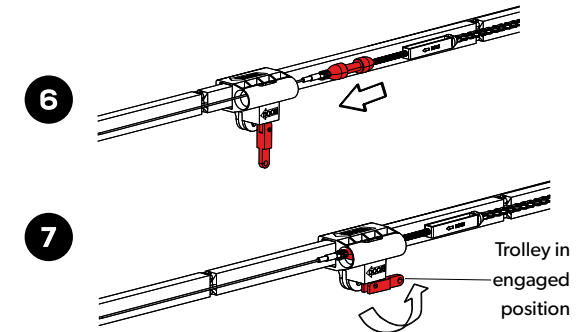

# INSTALLING CABLE AND CHAIN (BU100, BU400)

Bring cable and chain together and connect with master link. Check to make sure the chain is not twisted. If chain and cable are not close enough to connect with master link, loosen chain-to-cable connector to create more slack.

8

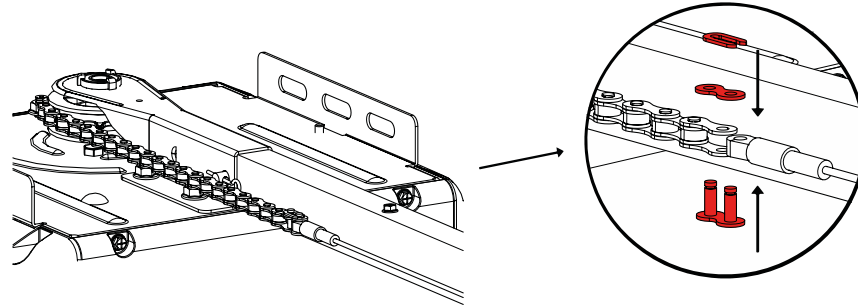

Adjust chain tension by turning chain-to-cable connector until chain is about 1/4 inch (.64cm) above the base of rail. Once proper tension is achieved tighten lock nut against chain-to-cable connector.

9

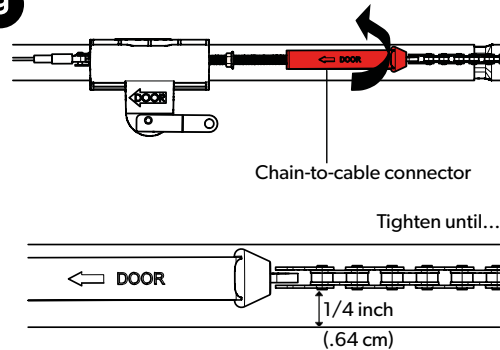

10

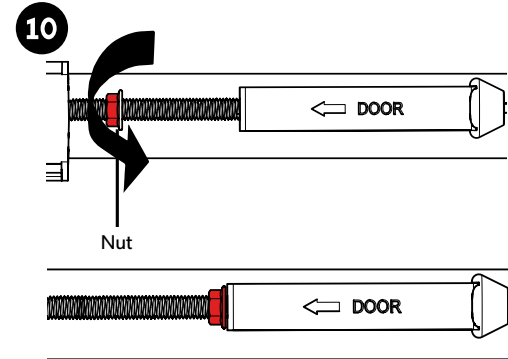

## ⚠️ WARNING



To prevent **SERIOUS INJURY**:

- DO NOT connect power until instructed.
- Keep hands and fingers clear from sprocket during operation.
- Wear gloves when installing chain and cable.
- Keep hands and fingers away from joints and possible sharp edges.

# INSTALLING BELT (BU800)

## Look in the box for:

Trolley Shaft/Belt Assembly

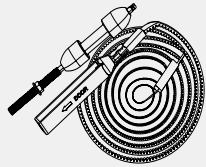

Master Link



## WARNING

To prevent **SERIOUS INJURY**:

- DO NOT connect power until instructed.
- Keep hands and fingers clear from sprocket during operation.
- Wear gloves when installing chain/belt and cable.
- Keep hands and fingers away from joints and possible sharp edges.



Loosely attach trolley shaft with belt connector. 5 complete turns will be sufficient.

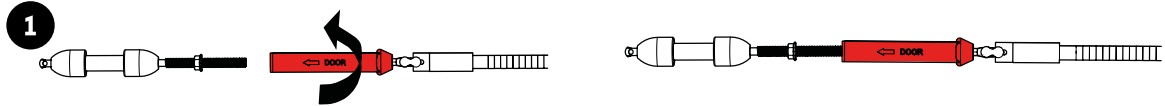

Pull trolley lock lever down to unlock. Insert screwdriver into the hole located on the rail-header segment. Slide the trolley up to the screwdriver. The trolley must stay in this position for proper alignment of the belt. Insert the trolley shaft through the trolley and pull lever back up.

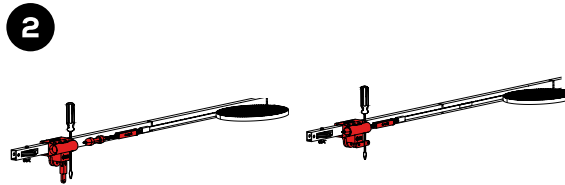

Pull belt along the rail towards power head and loop belt around the belt sprocket.

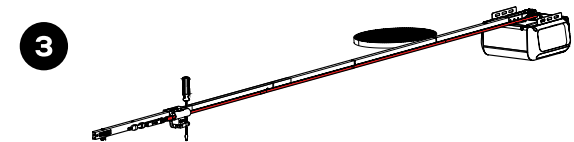

Sprocket teeth must engage the belt. Continue pulling belt towards trolley.

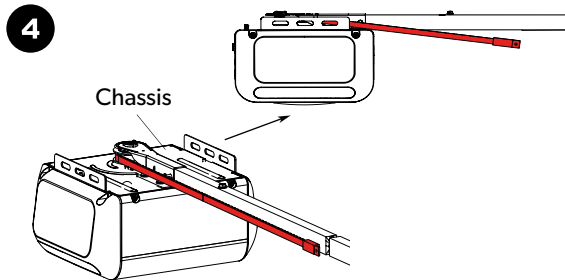

Insert belt through pulley slot and toward power head. The ribbed side must contact the pulley and should be facing inwards.

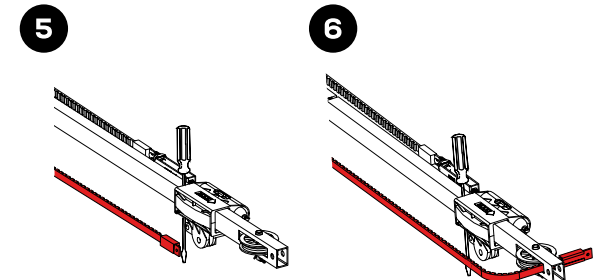

# INSTALLING BELT (BU800)

Bring belt and trolley shaft together, check to make sure the belt is not twisted. Connect belt and trolley shaft with master link. If belt connector and trolley shaft are not close enough to connect with master link, loosen belt connector to create more slack.

7

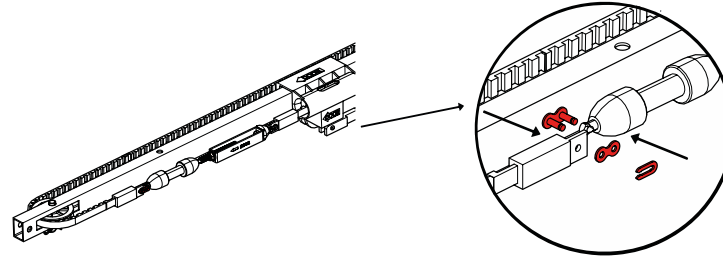

Adjust belt tension by turning belt connector until belt is about 1/4 inch (.64cm) above the base of rail. Once proper tension is achieved tighten lock nut against belt connector.

8

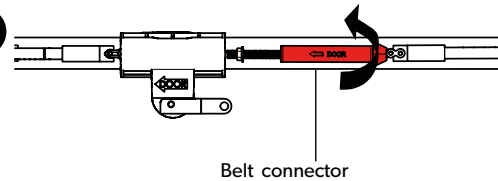

Tighten until...

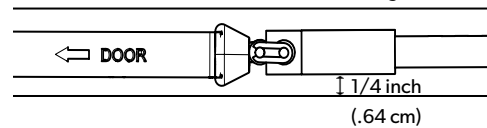

9

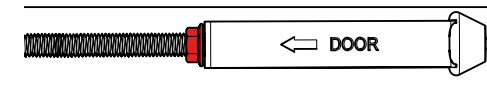
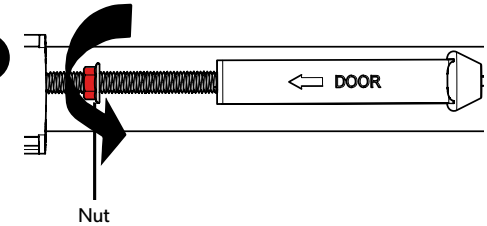

## ⚠ WARNING



To prevent **SERIOUS INJURY**:

- DO NOT connect power until instructed.
- Keep hands and fingers clear from sprocket during operation.
- Wear gloves when installing chain/belt and cable.
- Keep hands and fingers away from joints and possible sharp edges.

# ATTACHING SPROCKET COVER

Look in the box for:

Sprocket Cover

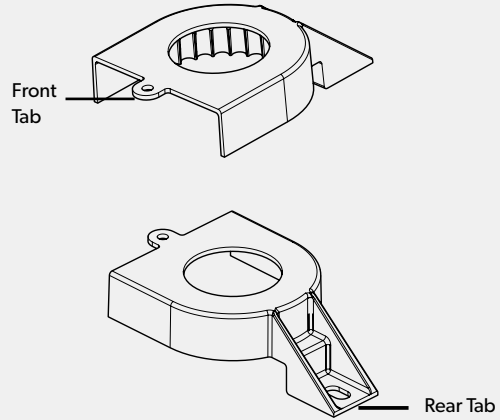

Self-Threading Screw  
#8-18 x 5/16

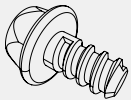

Flange Nut



Attach sprocket cover to power head.

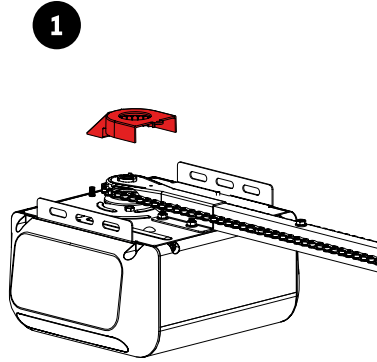

Fasten rear tab with flange nut on top of steel chassis.

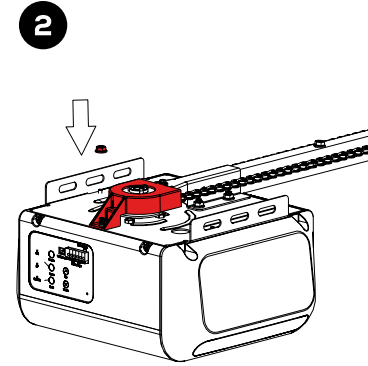

Fasten front tab with self-threading screws to hole on top of rail bracket.

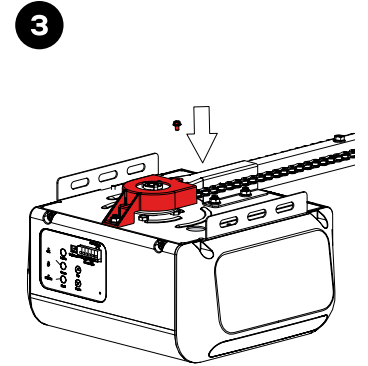

# MOUNTING HEADER BRACKET

Look in the box for:

Header Bracket

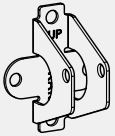

2 x Lag Screws  
5/16" x 1-1/2"

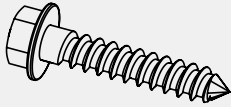

## ⚠ WARNING



To prevent **SERIOUS INJURY**:

- DO NOT connect power until instructed.
- The header bracket **MUST** be **SECURELY** fastened to the structural support on the mounting wall or ceiling, otherwise other door may not reverse when required. DO NOT install the header bracket over drywall.
- Concrete anchors **MUST** be used when mounting the header bracket into masonry.
- NEVER try to loosen, move or adjust garage door springs, cables, pulleys, brackets, or hardware.
- Contact a qualified garage door service technician if your door binds, sticks or is unbalanced. An unbalanced door might not reverse when required.

Mark the center line above the door with a pencil. Open door to the highest point of travel.

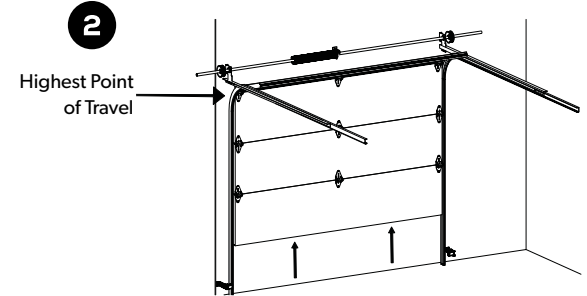
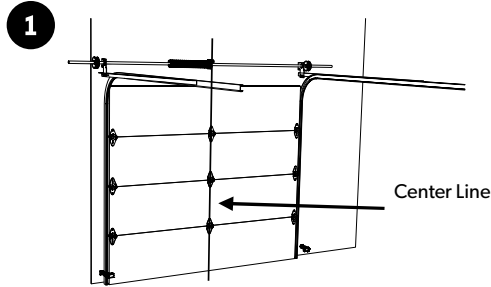

Take a level, measure and mark highest point of the door on the wall. Raise level to clear torsion bar if required, then mark highest point.

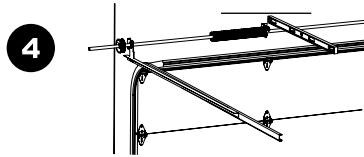
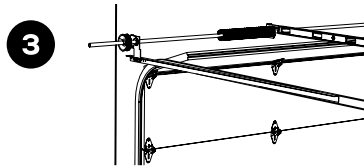

Measure 2 - 1/4 inch (5.7 cm), mark two holes of header bracket. Drill two holes and fasten header bracket using screws.

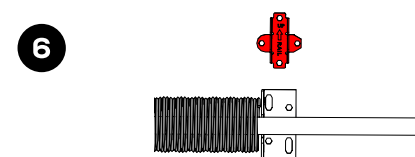
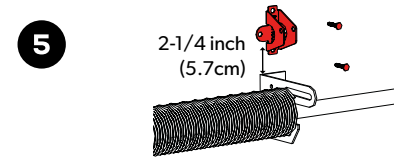

# ATTACHING RAIL AND MOUNTING DOOR BRACKET

## Look in the box for:

Hitch Pin



Clevis Pin  
5/16" x 1-3/8"

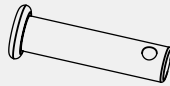

Door Bracket

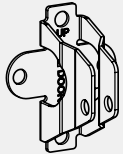

2 x Self-Threading  
Screws - 1/4" x 5/8"

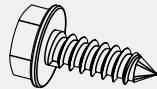

## CAUTION



To prevent **SERIOUS INJURY**:

- DO NOT connect power until instructed.
- REINFORCEMENT is recommended for fiberglass, aluminum or lightweight steel garage doors BEFORE installing the door bracket. Contact your door manufacturer for reinforcement options.

Use garage door opener carton to support power head. Rail header segment end should be pointing to header bracket.

1

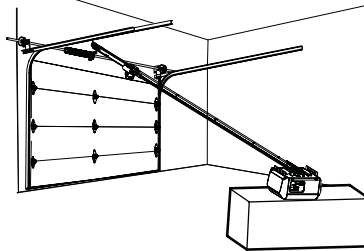

Align header rail hole to header bracket hole.

2

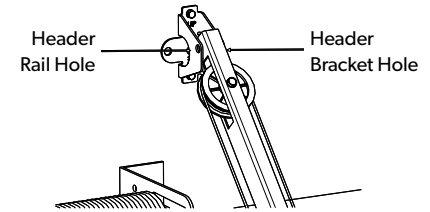

Connect header rail and header bracket with clevis pin and secure with hitch pin.

3

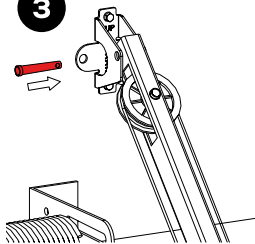

4

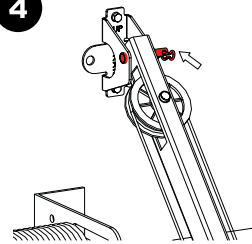

Position door bracket on centerline of the top garage door panel. Door bracket should be 2-4 inches (5-10 cm) below the top edge of door panel.

5

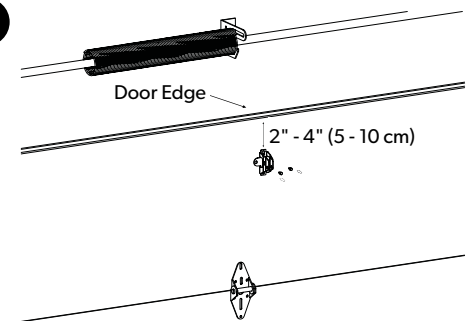

# MOUNTING POWER HEAD TO CEILING

## Look in the box for:

4 x Lag Screws  
5/16"-18 x 1"

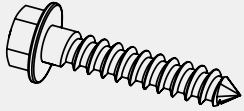

4 x Bolts  
5/16" - 18 x 1"

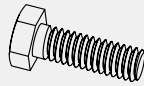

4 x Flange Nut



Hanging Brackets

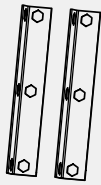

## ⚠ WARNING



To prevent **SERIOUS INJURY**:

- DO NOT connect power until instructed.
- Install the opener at least 7 feet (2.13m) above the floor.
- Fasten the opener **SECURELY** to **STRUCTURAL SUPPORT** of the garage to prevent falling.
- If installing brackets to masonry, concrete anchors (not provided) **MUST** be used.
- To prevent damage to garage door surface, rest garage door opener rail on 2x4 placed on top section of door.

Lift power head onto ladder. Position and align power head with rail assembly to centerline. Fully open door manually and place a 2x4 under the rail.\*

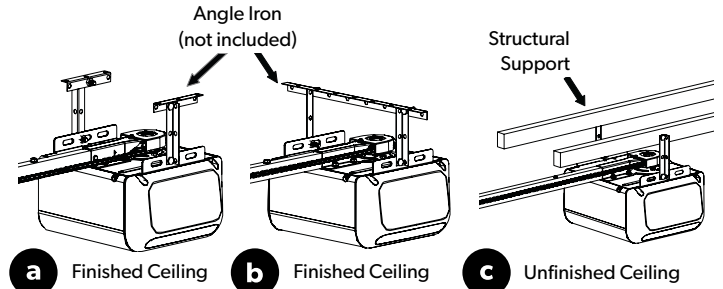
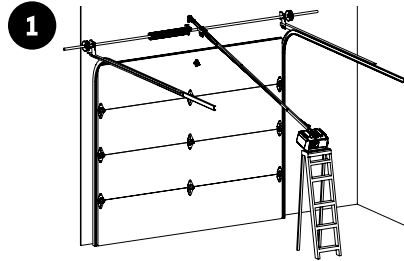

Three most common installation options. Determine the mounting option that works best for you.

Use lag screws to attach angle iron to the structural supports before installing the garage door opener onto a finished ceiling. Measure the distance from each side of the power head to the angle iron.

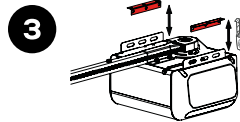
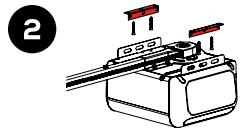

Cut both hanging brackets to appropriate length. Attach the end of each hanging bracket to the angle iron with 5/16" x 1" bolts and flange nuts.

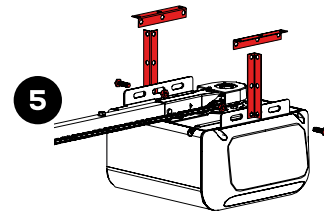

Attach power head to hanging brackets with 5/16" x 1" bolts and flange nuts. Remove 2x4 and manually close the door. If the door hits the rail, raise header bracket.

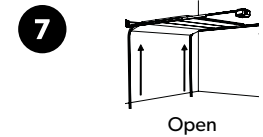
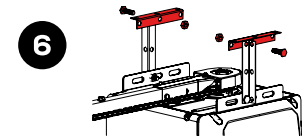



# ATTACHING DOOR ARMS

## Look in the box for:

Curved Door Arm

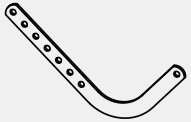

2 x Hitch Pins



2 x Bolts  
5/16" - 18 x 1"

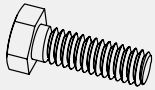

Straight Door Arm



2 x Clevis Pins  
5/16" x 1"

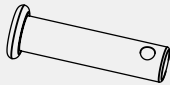

2 x Flange Nuts



## **WARNING**



To prevent **SERIOUS INJURY**:

- DO NOT connect power until instructed.
- Keep hands and fingers away from the sprocket during operation.
- Wear gloves when installing chain/belt and cable.
- Keep hands and fingers away from joints and possible sharp edges.

Close your garage door and disengage trolley. Fasten curved door arm to the door bracket with 5/16" x 1" clevis pin and secure with hitch pin.

1

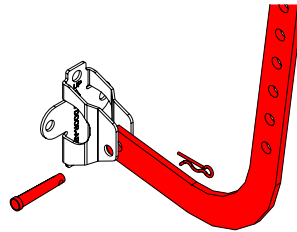

Fasten straight door arm to trolley with a 5/16" x 1" clevis pin and secure with hitch pin.

2

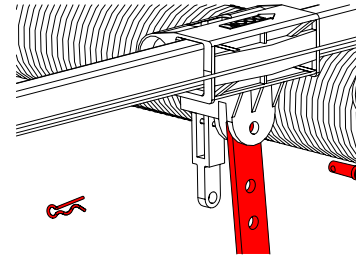

Attach door arms with two 5/16" bolts and flange nuts. Bring straight and curved door arm together. Find two pairs of holes that line up and join sections with two 5/16" bolts and flange nuts. Select holes as far apart as possible to increase door arm rigidity.

3

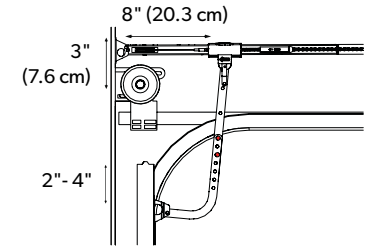

# INSTALLING EMERGENCY RELEASE HANDLE

Look in the box for:

Emergency Release Handle

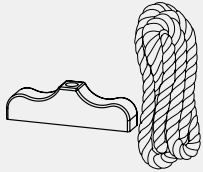

## ⚠ WARNING



To prevent **SERIOUS INJURY**:

- In case of power outage or door obstruction, **PULL EMERGENCY HANDLE** to release door from opener.
- When trolley is disengaged, (trolley lever pointing down) door can be operated manually.
- To engage, flip the trolley lever up so it is horizontal. Trolley will automatically re-engage when garage door opener is activated.
- **DO NOT** use emergency handle to pull the door open or close.

## \* **VERY IMPORTANT!** \*

Emergency release handle must clear all vehicles. An emergency release handle set too low may get caught by the vehicle and cause damage to the opener. Measure from the floor to the top of your vehicle and set the emergency release handle above this measurement.

Thread end of rope through handle and secure with an over hand knot. Thread end of the rope through hole in trolley lever.

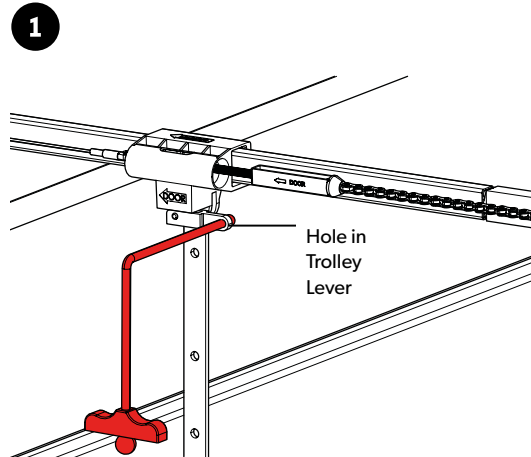

Measure rope length so the handle is 6 feet (183 cm) above the floor and is clear from the top of your vehicle. Secure with an overhand knot.

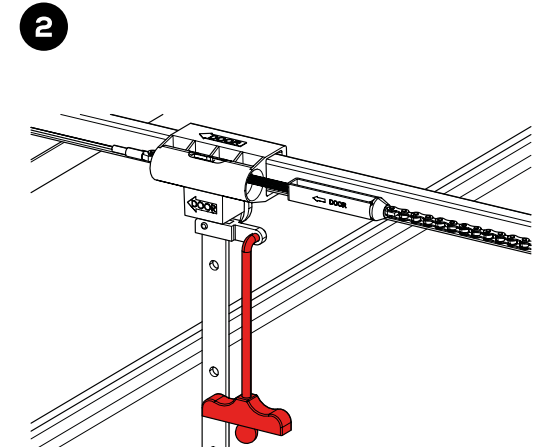

# CONNECTING PHOTO EYE SAFETY SYSTEM

Look in the box for:

Photo Eyes

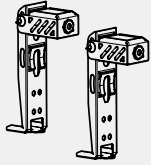

4 x Screws  
#12 x 1-1/4"

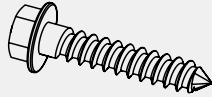

Insulated Staples



## ⚠ WARNING



To prevent **SERIOUS INJURY** or **DEATH** from electrocution:

- Power **MUST NOT** be connected until instructed.
- The garage door opener will not operate until the photo eye safety system is properly connected and aligned.
- Install the photo eye safety system **NO** higher than 6 inches (15 cm) above the floor.
- No part of garage door or other objects should obstruct the photo eye safety system during door-closing.

Mount photo eyes using #12 x 1-1/4" screws provided.

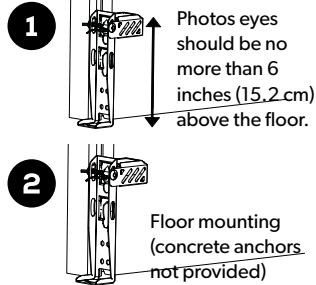

Alternative mounting location:  
Door track mounting

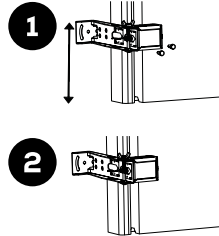

Run wire to power head. Use insulated staples to secure photo eye wires to wall and ceiling. Take care not to puncture the wires while securing staples.

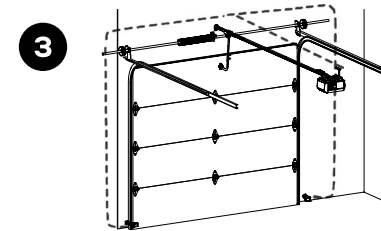

\* **VERY IMPORTANT!** \*

Strip 7/16 inch (1 cm) of insulation from the end of the wire.

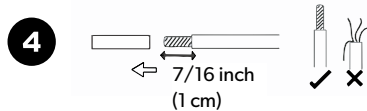

Each pair of terminals **MUST** be connected with one white wire and one striped wire (non-polarized) from the **SAME** photo eye.

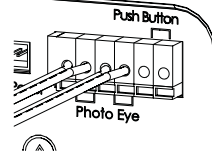

Cut and discard excess wire. Use small flat head screwdriver to push in grey tab on the terminal block located on the rear panel of the power head. Insert 1/2 inch (1.2 cm) of the wire into the terminal while pushing in the tab.

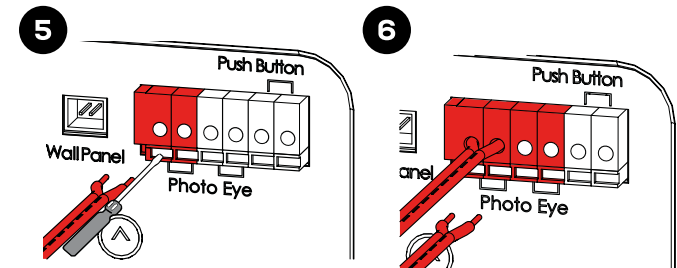

# CONNECTING POWER AND ALIGNING PHOTO EYE SAFETY SYSTEM

## NOTICE:

The garage door opener cannot be programmed and will not close the door until photo eye safety system are installed and aligned.

## WARNING

To prevent SERIOUS INJURY or DEATH from electrocution or fire:

- Power MUST be DISCONNECTED BEFORE proceeding with permanent wiring procedures.
- Garage door opener installation and wiring MUST be in compliance with all local electrical and building codes. Make sure the opener is ALWAYS grounded.
- NEVER use an extension cord, 2-wire adapter or modify the power plug in any way to make it fit the outlet.

To prevent SERIOUS INJURY or DEATH from a closing garage door:

- The photo eye safety system MUST be installed BEFORE connecting power.
- The photo eye safety system MUST be properly connected and aligned BEFORE operating the opener.



1

✓  
Right

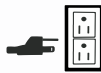

✗  
Wrong

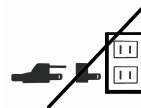

## \* DO NOT OPERATE OPENER AT THIS TIME \*

Plug power head into a grounded outlet ONLY. If there is no grounded outlet present, call a qualified electrician to replace the outlet. Use of a surge protector is highly recommended.

## For Permanent Wiring ONLY

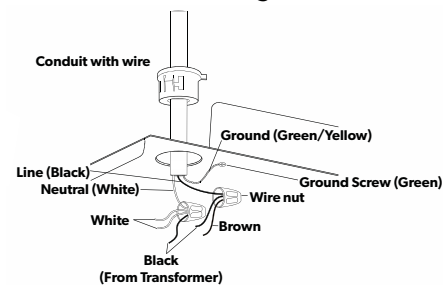

When the photo eye safety system is properly aligned green LED (emitter) will emit a steady green light and the red LED (sensor) will emit a steady red light. The path of the invisible light beam MUST NOT be obstructed. No part of the garage door or any hardware should interfere or block either sensor.

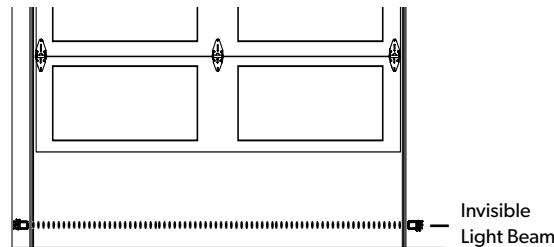

Green LED (emitter) will flash until it is aligned with red LED (sensor). Red LED will not illuminate until it is aligned with green LED.

Emitter  
Green LED ON

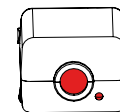

✓  
**Aligned**  
Steady Red &  
Green LED

Sensor  
Red LED ON

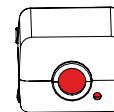

The emitter generates the invisible light beam, and the sensor receives the invisible light beam.

# CONNECTING DELUXE DOOR CONTROL (BU400, BU800)

## Look in the box for:

Deluxe Door Control\*

2 x Lag Screws  
#6 x 1-3/8"

2 x Anchors

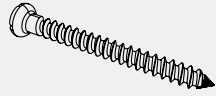

## ⚠ WARNING



To prevent **SERIOUS INJURY** or **DEATH** from electrocution or fire:

- Be sure power is **NOT** connected **BEFORE** installing door control.
- Connect door control **ONLY** to **12 VOLT** low voltage wires.

To prevent **SERIOUS INJURY** or **DEATH** from a closing garage door:

- Install door control within sight of garage door, at a minimum height of 5 feet (1.5 m) so small children are not able to reach it, and away from **ALL** moving parts of door.
- **NEVER** permit children to operate or play with door control or remote controls.
- Activate garage door opener **ONLY** when door can be seen clearly, is properly adjusted, and there are no obstructions to door travel.
- **ALWAYS** keep a moving garage door in sight until completely closed. **NEVER** cross path of moving garage door.

Wire deluxe door control to power head as shown.

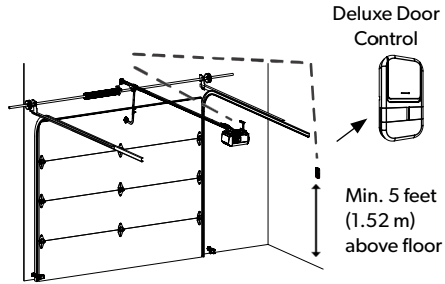

1. Strip 7/16 inch (11 mm) of insulation from wire and separate wires.
2. Connect one wire to each of the two screws on the back of the door control. **\*DO NOT RECOMMEND USING PRE-EXISTING WIRE\***
3. Mark the location of bottom mounting hole and drill 5/32 inch hole.
4. Install the bottom screw and allow 1/8 inch (3 mm) to protrude from wall. Note: Use anchors if mounting to drywall.
5. Position bottom hole of door control over the screw and slide down into place.
6. Lift actuation button and mark the top hole. Remove the door control from wall and drill 5/32 inch hole for top screw
7. Position bottom hole of door control over the screw and slide down into place. Fasten the top screw

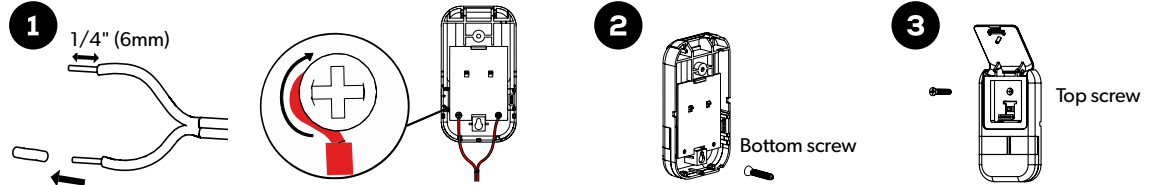

Connect plug from deluxe door control to wall panel outlet on the back panel of the power head.

**\*\*If using pre-existing wire you may cut off plug and splice to existing wire\*\***

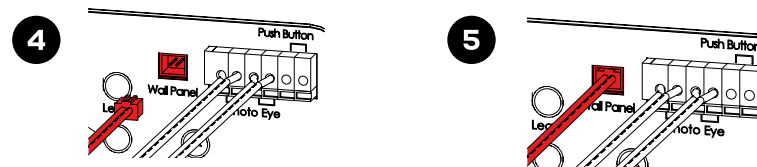

See how to use deluxe door control on page 20.

# MOTION ACTIVATED SECURITY LIGHTING (BU400, BU800)

## Look in the box for:

### Deluxe Door Control

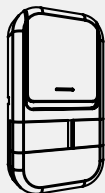

Using the Deluxe Door Control  
ONLY after Installation is completed



Door-Press and release to open/close the door.



Press and hold to activate/deactivate motion sensing security lighting. Turns the courtesy light on/off.

### Vacation Lock



Unlock - Slide lock button to the right to enable all remotes, door control and accessories.



Lock - Slide lock button to the right to disable all remotes, door control and accessories.

Security lighting is activated and remains on for 4.5 minutes when garage door opener is operated.

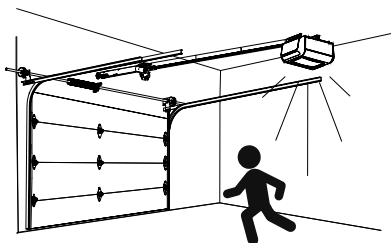

Motion sensing is turned on by default and will activate security lighting when motion is detected within the garage. Security lighting will remain illuminated for 4.5 minutes or for as long as there is motion in the garage.



4.5 Min

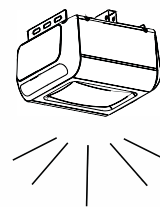

\*Note - if you wish to turn off security lighting when motion sensing is activated press the "LIGHT" button and security lighting will turn off and remain off for 25 seconds. If motion is detected after 25 seconds, security lighting will turn on.\*

To deactivate motion sensing: Press and hold "LIGHT" button for 2 seconds. The power head will beep once to indicate motion sensing has been deactivated.

To active motion sensing: Press and hold "LIGHT" button for 2 seconds. The power head will beep 3x to indicate motion sensing has been activated.



2 Sec

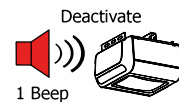

1 Beep

Activate

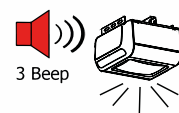

3 Beep

# CONNECTING STANDARD DOOR CONTROL (BU100)

## Look in the box for:

Standard Door Control

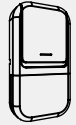

2 x Lag Screws  
#6 x 1-3/8"

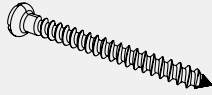

2 x Anchors



## ⚠ WARNING



To prevent **SERIOUS INJURY** or **DEATH** from electrocution or fire:

- Be sure power is **NOT** connected **BEFORE** installing door control.
- Connect door control **ONLY** to 12 VOLT low voltage wires.

To prevent **SERIOUS INJURY** or **DEATH** from a closing garage door:

- Install door control within sight of garage door, at a minimum height of 5 feet (1.5 m) so small children are not able to reach it, and away from **ALL** moving parts of door.
- **NEVER** permit children to operate or play with door control or remote controls.
- Activate garage door opener **ONLY** when door can be seen clearly, is properly adjusted, and there are no obstructions to door travel.
- **ALWAYS** keep a moving garage door in sight until completely closed. **NEVER** cross path of moving garage door.

Wire standard door control to opener as shown.

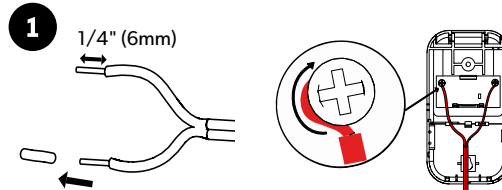
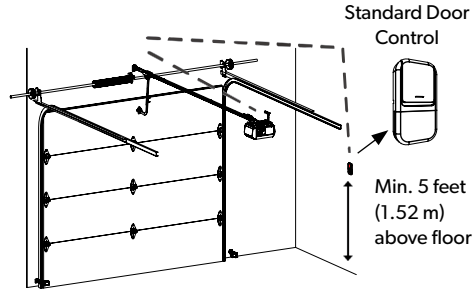

Connect the wire from the standard door control to the push button terminal on the rear panel of the power head.

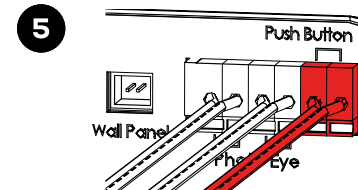
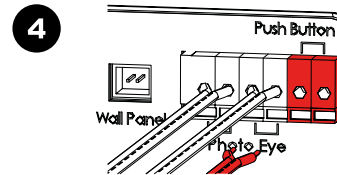

1. Strip 7/16 inch (11 mm) of insulation from wire and separate wires.
2. Connect one wire to each of the two screws on the back of the door control. **\*DO NOT RECOMMEND USING PRE-EXISTING WIRE\***
3. Mark the location of bottom mounting hole and drill 5/32 inch hole.
4. Install the bottom screw and allow 1/8 inch (3 mm) to protrude from wall. Note: Use anchors if mounting to drywall.
5. Position bottom hole of door control over the screw and slide down into place.
6. Lift actuation button and mark the top hole. Remove the door control from wall and drill 5/32 inch hole for top screw.
7. Position bottom hole of door control over the screw and slide down into place. Fasten the top screw.

# BEFORE WE START PROGRAMMING THE OPENER

Before programming the garage door opener please ensure the following steps are completed:

Door is fully closed.

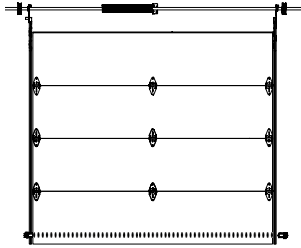
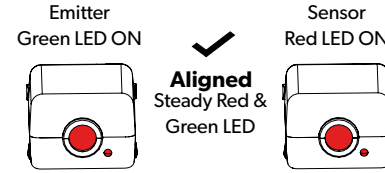
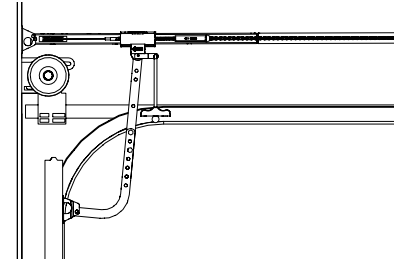

Photo eyes are aligned.



Trolley shaft is engaged with trolley.



To engage trolley shaft with trolley.

Flip lever on trolley so it is in engage position (horizontal and pointing at the opener)

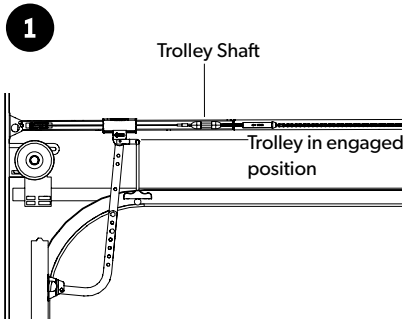

If trolley shaft is closer to the opener (behind the trolley): press and release "Limit" button and then press and hold the red "DOWN" button to move trolley shaft towards the door. There will be an audible click once the trolley shaft is engaged with trolley.

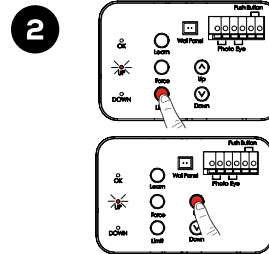

If trolley shaft is closer to the door (in front of the trolley): press and release "Limit" button and then press and hold the green "UP" button to move trolley shaft towards the opener. There will be an audible click once the trolley shaft is engaged with trolley.

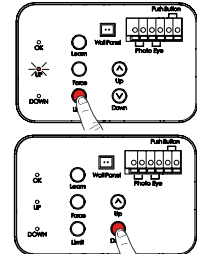



# TRAVEL LIMIT ADJUSTMENT - UP LIMIT

## NOTICE:

Travel limits and auto force setting must be set for the opener to work. All steps on pages 23-25 must be followed.

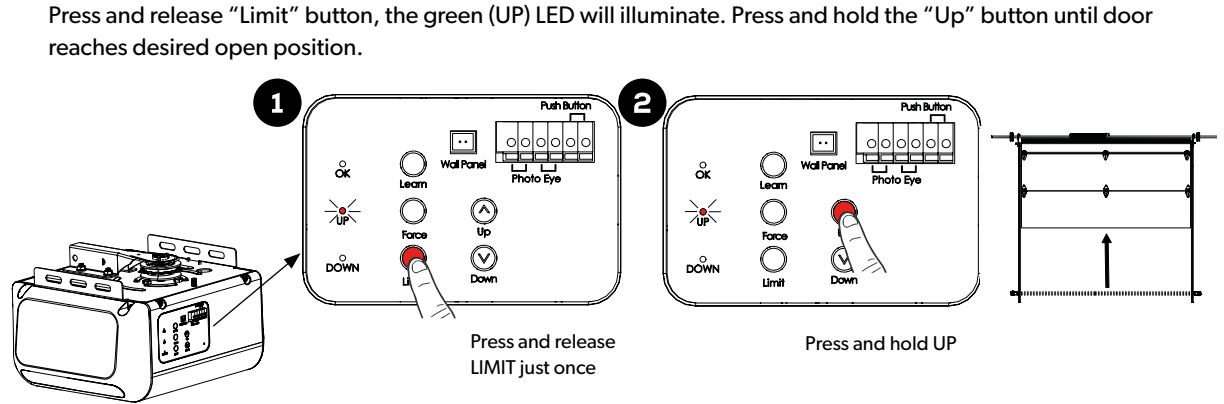

## ⚠ WARNING

To prevent SERIOUS INJURY or DEATH from improper Force Adjustment:

- YOU CANNOT adjust force manually to compensate for binding or sticking of the garage door. Call a qualified garage door service person to make necessary adjustments in case of binding.
- YOU CANNOT manually increase the force required for closing the door.
- After ANY adjustments, Safety Reversal Test MUST be performed to ensure the door reverses on contact with a 1-1/2 inch (3.8 cm) high object (2x4 laid flat).

### \* DO NOT HIT STOP BOLT \*

There should be a minimum 2 inch (5 cm) gap between trolley and stop bolt.

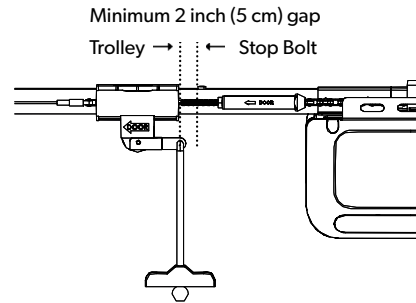

Once the door is at the desired open position, press and release the "Limit" button once. The "OK" LED flashes and turns off. The UP Limit has now been set.

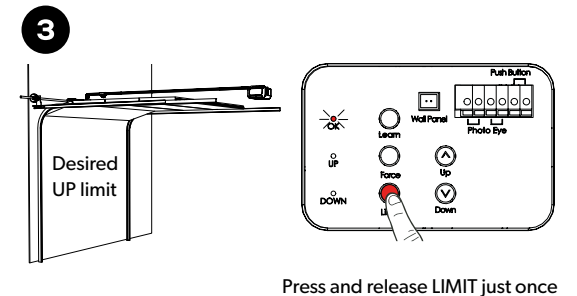

# TRAVEL LIMIT ADJUSTMENT - DOWN LIMIT

## NOTICE:

Travel limits and auto force setting must be set for the opener to work. All steps on pages 23-25 must be followed.

Press and release "Limit" button twice, the red (DOWN) LED will illuminate. Press and hold the "Down" button until door reaches desired close position.

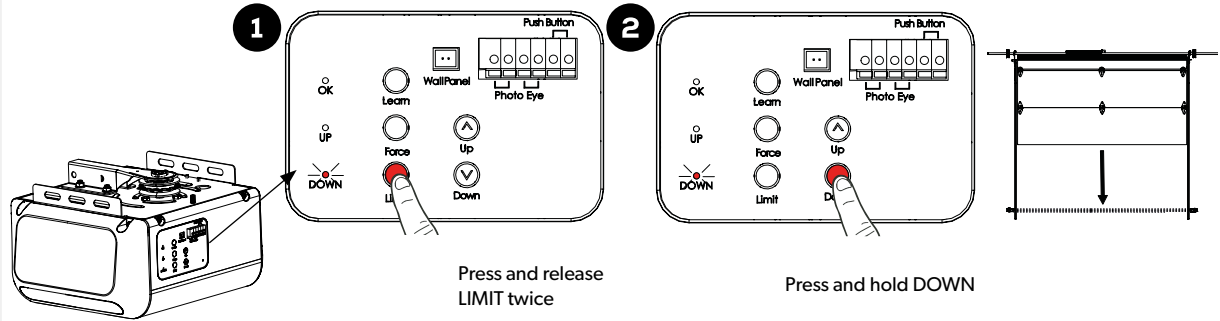

Once the door is at the desired close position, press and release the "Limit" button once. The "OK" LED flashes and turns off. The DOWN Limit has now been set.

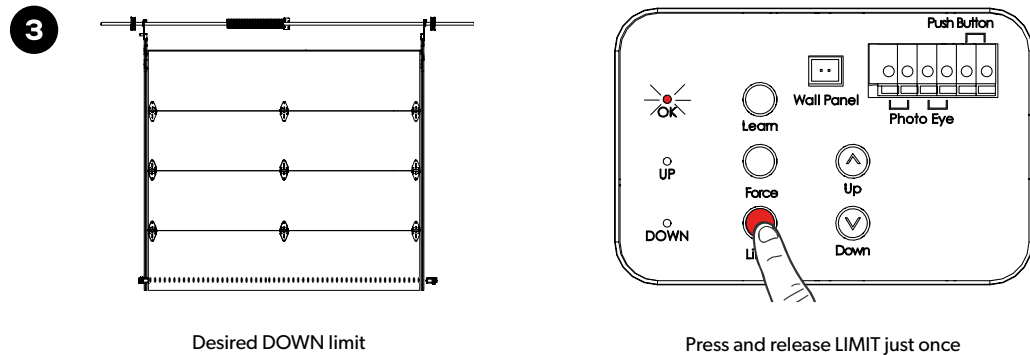

## WARNING



To prevent SERIOUS INJURY or DEATH from improper Force Adjustment:

- YOU CANNOT adjust force manually to compensate for binding or sticking of the garage door. Call a qualified garage door service person to make necessary adjustments in case of binding.
- YOU CANNOT manually increase the force required for closing the door.
- After ANY adjustments, Safety Reversal Test MUST be performed to ensure the door reverses on contact with a 1-1/2 inch (3.8 cm) high object (2x4 laid flat).

# SETTING THE FORCE

## NOTICE:

Travel limits and auto force setting must be set for the opener to work. All steps on pages 23-25 must be followed.

## ⚠ WARNING



To prevent SERIOUS INJURY or DEATH from improper Force Adjustment:

- YOU CANNOT adjust force manually to compensate for binding or sticking of the garage door. Call a qualified garage door service person to make necessary adjustments in case of binding.
- YOU CANNOT manually increase the force required for closing the door.
- After ANY adjustments, Safety Reversal Test MUST be performed to ensure the door reverses on contact with a 1-1/2 inch (3.8 cm) high object (2x4 laid flat).

Once UP and DOWN limits are set, ensure both UP and DOWN LEDs are illuminated. \*if necessary toggle "Limit" button until both LEDs are illuminated\*

Press and release the "Force" button once. Door will travel one complete cycle followed by flashing of the "OK" LED and 3 beeps. Programming is now complete.

1

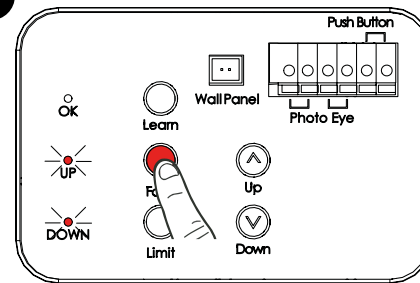

The door will travel UP automatically.

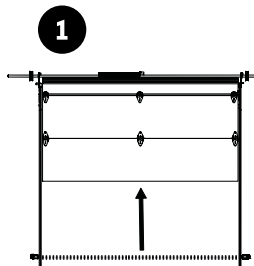

Stop at UP limit for 2 seconds.

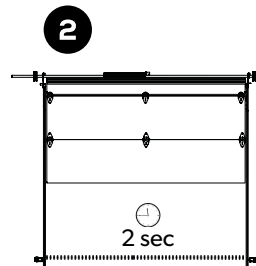

Door will then travel DOWN automatically.

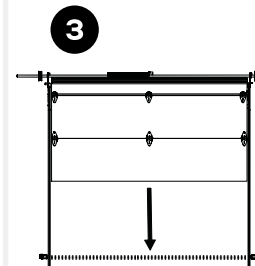

OK indicator (orange) will flash with beeps, Auto Force Setting is completed.

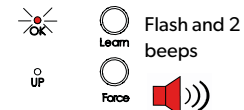
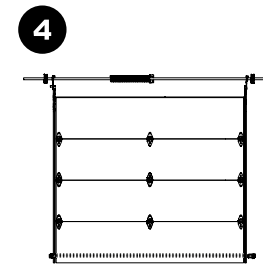

# FINAL ADJUSTMENTS AND TESTING

## NOTICE:

Travel limits and auto force setting must be set for the opener to work. All steps on pages 23-25 must be followed.

## ⚠ WARNING



To prevent SERIOUS INJURY or DEATH from a closing garage door:

- The Safety Reversal Test MUST be conducted ONCE A MONTH.
- NO ONE should cross the path of moving door during operation and/or testing.
- After ANY adjustments to the door system, the Safety Reversal Test MUST be performed to ensure the door reverses on contact with a 1-1/2 inch (3.8 cm) thick (2x4 laid flat) object.
- The Photo Eye Safety System MUST be properly aligned, and tested regularly.

### Test the Safety Reversal System

Open door using door control.

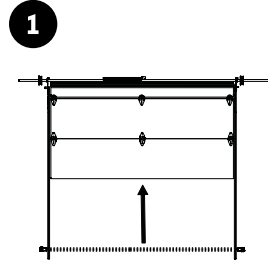

Place a 1-1/2 inch (3.8cm) flat solid object on the floor, centered under the garage door.

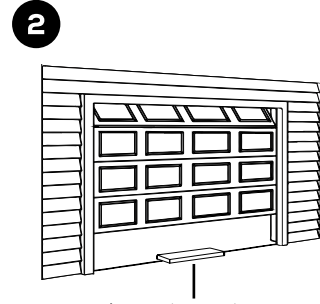

1-1/2 inch (3.8 cm) solid object

Use door control or remote to close door. Door MUST reverse\* upon making contact with the object.

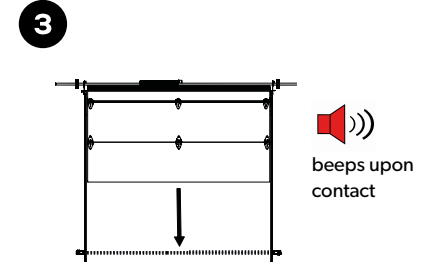

### Test the Photo Eye Safety System

1. Open door by using the door control.
  2. Make sure photo eye safety system is aligned with both the red and green LEDs illuminated. If not, refer back to pages 17-18.
  3. Place the garage door opener carton in the path of the door.
  4. Keeping the door in sight press the door control or remote control to close the door
- Door should NOT move more than 1 inch (2.5 cm) and the garage door opener will beep and flash 20 times.

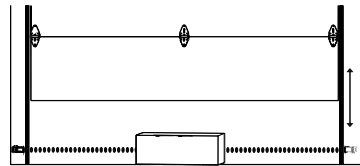

#### Emitter

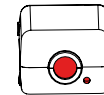

Green LED  
Flashes



20 beeps and  
reverses upon  
obstruction

#### Sensor



Red LED  
OFF

# PROGRAMMING HANDHELD REMOTE CONTROL\*

## Look in the box for:

Single Button Remote  
BU100

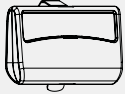

Three Button Remote  
BU400 & BU800

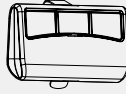

## ⚠ WARNING



To prevent **SERIOUS INJURY** or **DEATH**:

- Keep remote control and battery out of reach of children.
- NEVER permit children to access door control or remote control.
- Operate the door **ONLY** when it is properly adjusted, and there are no obstructions present.
- ALWAYS keep a moving door in sight until completely closed. NEVER cross the path of a moving door.

To reduce risk of fire, explosion or electric shock:

- DO NOT short circuit, recharge, disassemble or heat the battery.
- Replace with a CR2032 3 volt battery **ONLY**.

1. Press and release the "Learn" button.
2. The "OK" LED will illuminate indicating ready for programming.



Beeps



30 sec

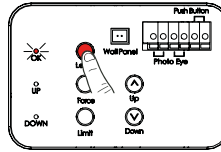

Press and release LEARN

3. Press desired button on remote control within 30 seconds to program.

\*Additional buttons on remote can be used to program multiple beamUP garage door openers\*

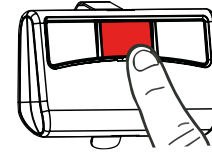

The "OK" LED flashes twice followed by two beeps to confirm remote has been programmed.

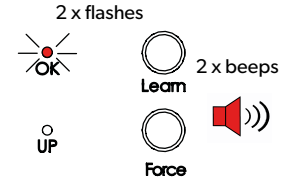

Erasing ALL remote controls from memory:

To erase ALL remote controls from memory, press and hold "Learn" button for 3 seconds. "OK" LED will flash and beep three times indicating all remotes have been erased from memory.



Beeps

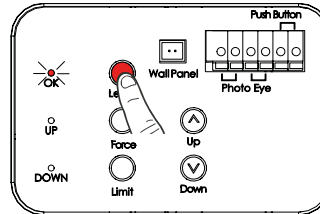

Press and hold LEARN 3 sec

When battery of hand held remote control is low, indicator LED will become dim and/or range of remote control will decrease. To replace battery, remove battery cover from remote control. Replace with a CR2032 3 volt battery.

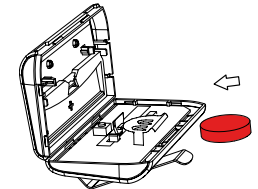

# PROGRAMMING WIRELESS KEYPAD (BU800)

## Look in the box for:

Wireless keypad\*



2 x Lag Screws #6 x 1-3/8"

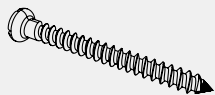

2 x Anchors



## ! WARNING



To prevent **SERIOUS INJURY** or **DEATH**:

- Keep remote control and battery out of reach of children.
- Never permit children to access the door control or remote control.
- Operate door **ONLY** when it is adjusted properly with no obstructions to door travel and is in clear sight.
- **ALWAYS** keep a moving door in sight until completely closed. **NO ONE** should cross the path of a moving door.

To reduce risk of fire, explosion or electric shock:

- **DO NOT** short circuit, recharge, disassemble or heat battery.
- Replace with 2 x AAA batteries **ONLY**. Dispose of batteries properly.

1. Press and release the "Learn" button.
2. The "OK" LED will illuminate indicating ready for programming.
3. Garage door opener is ready to accept PIN within the next 30 seconds.

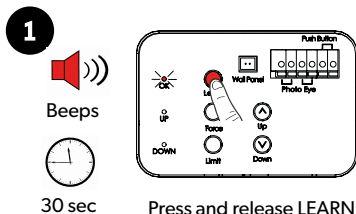

Enter your 2-6 digit PIN within 30 seconds and press the  button.

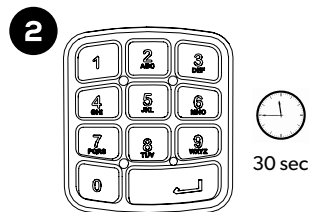

"OK" LED will flash and beep twice indicating code is set.

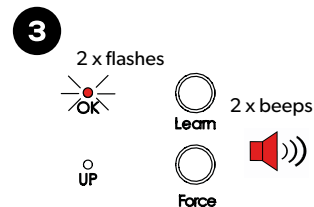

Erasing **ALL** remote controls from memory:

To erase **ALL** remote controls from memory, press and hold "Learn" button for 3 seconds. "OK" LED will flash and beep three times indicating all remotes have been erased from memory.

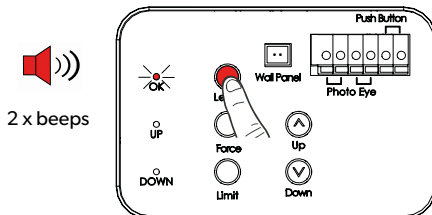

Wireless keypad may be secured on door jamb outside your garage. Install keypad within sight of door at minimum height of 5 feet (1.5 m). Test the range of the keypad before mounting. Find an alternative mounting location if range is insufficient.

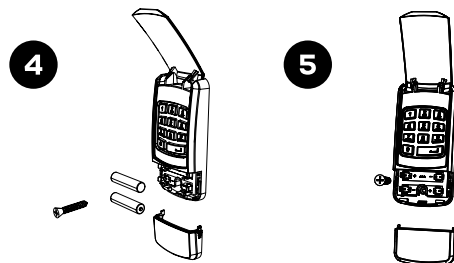

# INSTALLING THE SMART GARAGE DOOR CONTROLLER (BU400, BU800)

Look in the box for:

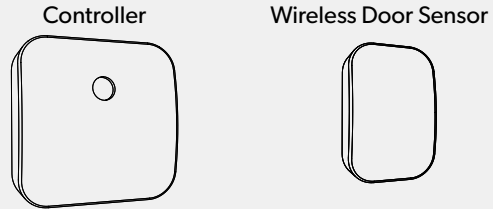

## **WARNING**

To reduce the risk of injury to persons:

- Use this Smart Control Kit only with residential sectional garage doors.
- Do not enable this device on a one-piece or swinging garage door.
- Do not use this device on garage door openers made before 1993 without a working photo eye safety system.

Installation and programming of your beamUP garage door opener is now complete.

- Locate the beam Smart Garage Door Controller
- Follow instructions in the Smart Garage Door Controller installation guide to add smart phone control to your beamUP garage door opener.

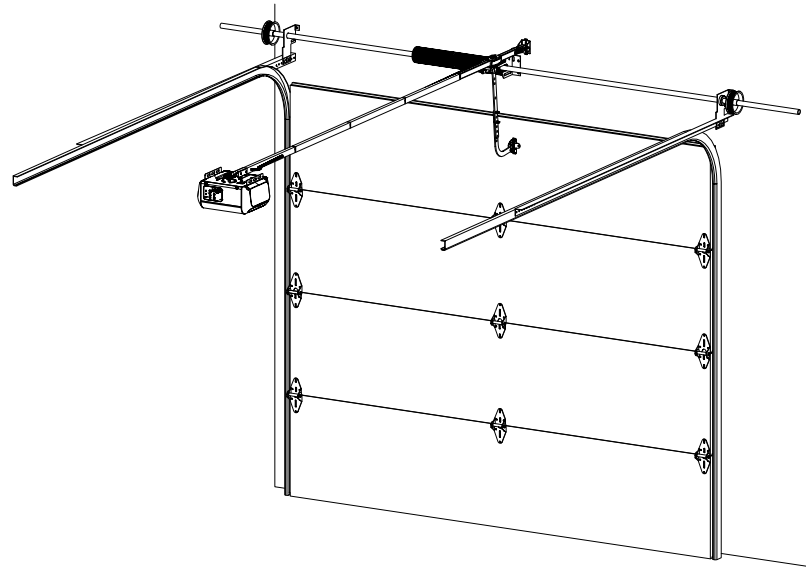

# USING YOUR GARAGE DOOR OPENER

## **WARNING**

To prevent **SERIOUS INJURY** or **DEATH**:

- READ AND FOLLOW ALL INSTRUCTIONS AND WARNINGS IN THE OWNER'S MANUAL AND LABELS
- Keep remote control and batteries out of reach of children.
- NEVER permit children to access door controls or remote controls.
- Operate the door **ONLY** when it is properly adjusted, and there are no obstructions and is in clear sight.
- ALWAYS keep a moving door in sight until completely closed. NEVER cross the path of a moving door.
- After ANY adjustments, the Safety Reversal Test **MUST** be performed to ensure the door reverses on contact with a 1-1/2 inch (3.8 cm) thick object (2x4 laid flat).
- ALWAYS ensure that your door is balanced and in good working condition.

## Activating the Opener

### Controls

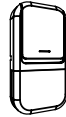

Door Control

### Operation

Momentary press large "ACTUATOR" button on the door control, the door starts to move, and controls as follows:

- Open or close the door.
- Stops the door while closing
- Stops the door while it is opening.

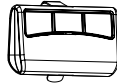

Handheld Remote Control

Remote distance up to 100 feet in open field. For safety concerns, the handheld remote control **WILL NOT** work if the photo eye safety system is not properly installed and aligned or if vacation lock is activated.



Wireless Keypad

Program the wireless keypad accordingly and access the door using the PIN code.



# USING YOUR GARAGE DOOR OPENER

## **WARNING**

To prevent **SERIOUS INJURY** or **DEATH**:

- Use emergency release to disconnect trolley **ONLY** when the door is **CLOSED** to prevent unexpected rapid falling in case of a unbalanced / poor-conditioned door.
- Use emergency release **ONLY** when doorway is clear of persons and obstructions.
- **DO NOT** use emergency release to pull the door open or closed.

## Door Status vs. Activation

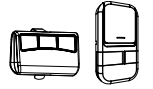

### Door Status

### Activation Using Door Control / Remote Control

Door at fully open / close position

Door will move to fully close / open position

Door is closing

Door will stop. Upon next activation door will reverse to fully open position.

Door is opening

Door will stop. Upon next activation door will continue to open.

Door is obstructed while closing

Door will reverse and beep x 25

Door is obstructed while opening

Door will stop and beep x 25

Door is fully opened and photo eye safety system is obstructed

Door will not close and beep x 20

# USING YOUR GARAGE DOOR OPENER

## **WARNING**

To prevent SERIOUS INJURY or DEATH:

- Use emergency release to disconnect trolley ONLY when the door is CLOSED to prevent unexpected rapid falling in case of a unbalanced / poor-conditioned door.
- Use emergency release ONLY when doorway is clear of persons and obstructions.
- DO NOT use emergency release to pull the door open or closed.

## Courtesy Light / Buzzer Responses



Operation / Condition	Courtesy Light / Buzzer Responses
Opener is initially plugged-in (no travel limits stored see pages 23-25):	UP and DOWN indicators blink 5 times
Reconnecting power (with travel limits stored)	Light On for 4.5 minutes
“LEARN” button is pressed	Beep x 1, OK indicator glows
Upon activation	Light on for 4.5 minutes
Upon activation by remote controls	Beep x 1, Light on for 4.5 minutes
Remote control / keyless entry PIN code stored successfully	Beep x 2
Photo eye safety system is obstructed during door-closing	Beep x 20
The door is obstructed during travel	Beep x 25
Door travels with abnormal speed	Beep x 12 (1 beep / second)

# USING YOUR GARAGE DOOR OPENER

## Manual Operation

In case of a power failure or door obstruction, PULL EMERGENCY HANDLE to release door from opener.

## To Disengage Trolley for Manual Operation

With door closed, pull down emergency handle to disengage position. Door can be raised / lowered manually.

## To Engage Trolley

Pull the handle toward opener so that lever will flip up to engage position. Trolley will reconnect itself when opener is activated or when the door is manually opened / closed.

Engage:  
Pull to disengage

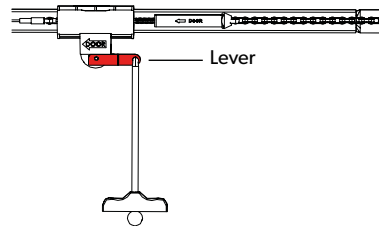

Disengage:  
Flip to engage

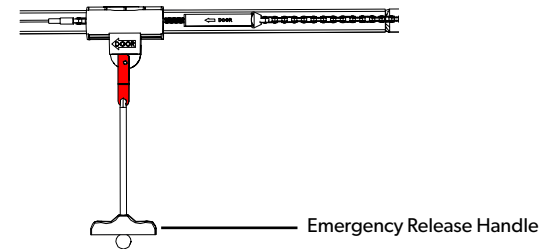

# USING YOUR GARAGE DOOR OPENER

## Using the Deluxe Door Control

(ONLY after programming has been completed)



Door – Press and release to open/close the door



Light – Turns the courtesy light on/off

Press and hold to activate/deactivate motion sensing security lighting



Vacation Lock

Unlock – Slide lock button to the right to enable all remotes, door control and accessories.



Lock – Slide lock button to the left to disable all remotes, door control and accessories.

# TROUBLESHOOTING

## NOTICE

Opener will not work until you set the travel limits and the auto force adjustment. You must follow all steps located on pages 23-25.

Soft open / Soft close feature: opener is designed to start slowly, accelerate to full speed, then slowly stop. Soft open/close is designed to reduce strain on openers components and to improve opener longevity.

<b>Problem</b>	<b>Possible Cause / Solution</b>
Opener does not close and beeps x 20	The photo eye may be obstructed, not properly aligned or installed, check connection and alignment by referring to page 17.
Opener does not respond to remote control	<ul style="list-style-type: none"><li>• Refer to page 27 to reprogram remote control.</li><li>• Check remote control battery and vacation switch if deluxe door control is installed.</li></ul>
Opener stops before reaching full open / close position	Travel Limit is not properly set, check adjustment referring to pages 23-25. Conduct safety reverse test after ANY adjustment.
Door reverses unintentionally	<ul style="list-style-type: none"><li>• Make sure the photo eye safety system is aligned and clear of obstructions.</li><li>• Refer to page 3 to check the door balance</li><li>• Refer to pages 23-25 to reset travel limits and force adjustment.</li></ul>
Door reverses and courtesy light flashes	Refer to pages 23-25 to reset travel limits and force adjustment.
Opener does not close the door and LED on one of photo eyes flashes	The photo eye safety system is misaligned or obstructed, refer to page 17-18 for proper alignment.

# TROUBLESHOOTING

<b>Problem</b>	<b>Possible Cause / Solution</b>
Opener is working properly but courtesy light does not turn on	Replace LED cluster.
Courtesy light does not turn off	Replace logic board.
Opener hums as trolley hits the trolley stop	<ol style="list-style-type: none"><li>1. Disconnect trolley by using the emergency release.</li><li>2. Close door manually.</li><li>3. Relieve chain-to-cable connector by loosening both, refer to page 8.</li><li>4. Operate opener so trolley shaft travels towards door (trolley should be kept disengaged).</li><li>5. Refer to page 23 to reset UP Limit.</li><li>6. Refer to page 8 to re-tighten chain-to-cable connector until it is 1/4 inches (.64 cm) above the base of rail (reference the figure shown on page 8).</li><li>7. Repeat the above steps if trolley still hits the stop bolt.</li></ol>

# MAINTENANCE

Schedule	Maintenance
Once a month	Door balance test, refer to page 3.
Twice a year	Safety reversal test, refer to page 26.
Once a year	<p>Check cable/chain tension (refer to page 8 for adjustment if necessary).</p> <ul style="list-style-type: none"><li>• Limit and Force adjustment may be necessary due to weather conditions. Refer to pages 23-25 for adjustment. Conduct Safety Reversal Test after ANY adjustments.</li><li>• Lubricate door rollers, bearings and hinges. The opener is permanently lubricated, DO NOT lubricate or grease the opener, rail or door tracks.</li></ul>

# WARRANTY

Manufacturer hereby warrants to the original purchaser, for initial residence in which it is installed:

1. Garage Door Operators to be free from defects in material and workmanship for a period of one (1) year from date of purchase. The model BU100 motor is to be free from defects in materials and workmanship for 5-years from the date of purchase. The models BU400 and BU800 motor is to be free from defects in materials and workmanship for the lifetime of the product.
2. Where the garage door operator has need to be returned to the Manufacturer for Warranty repairs, all costs incurred in the return will be paid for by the purchaser. Call 1-800-436-9186 prior to dismantling the product. If in the opinion of the Manufacturer the product is faulty, all defective parts will be replaced at no charge to the purchaser.
3. Proof of purchase must be given to the Manufacturer at time of Warranty claim.
4. The Manufacturer reserves the right to modify any existing or future products without incurring any obligation to incorporate such modification to products already manufactured or to which this Warranty may relate.
5. Warranty only applies if this product has been installed to the Manufacturer's instructions.
6. This Warranty does not apply to any defect, loss or damage arising or caused directly or indirectly by or as a result of :
  - (i) Any defect (including defects in component parts or accessories) arising from or attributable to the failure to carry out normal preventive maintenance or adjustment itself.
  - (ii) To any additional damage or deterioration arising from attributable to the operation

of the Operator after it is known to be defective.

7. Not included in Warranty:

- (i) Batteries
- (ii) Fuses
- (iii) Sensitivity adjustment
- (iv) Handheld Remote Controls and receiver range

8. Note : All Warranties will be void subject to:

- (i) Water damage and condensation
- (ii) Power supply black out or surge
- (iii) Act of God
- (iv) Modification or adjustment by unauthorized persons
- (v) Any interference from radio (including citizen band radios or and other electronic device)
- (vi) Preventative maintenance and regular servicing not undertaken
- (vii) Account not paid in full by the purchaser



# WARRANTY

9. Subject only to the provisions of the Trade Practices Act and any legislation of the State or Territory wherein the operators of the Manufacturer have been sold or installed (which may confer certain rights on consumers of goods and those rights by such legislation may be rendered incapable of exclusion) this Warranty supersedes and excludes all representations, warranties and conditions whether expressed or implied by law and the Manufacturer shall have no liability or otherwise than herein provided for any loss and damage (including consequential loss and damage, loss of use or profits) by reasons of delay, defective or faulty materials or workmanship, negligence or any act, matter or thing done permitted or omitted to be done by the Manufacturer.

## Warranty

THIS WARRANTY FORM SHOULD BE COMPLETED AT TIME OF INSTALLATION

This Warranty Form should be retained by the purchaser at all times and produced with the purchase docket by the

Purchaser as proof of the purchase date \_\_\_\_\_

PURCHASER'S NAME: \_\_\_\_\_

PURCHASER'S ADDRESS: \_\_\_\_\_

INSTALLED BY: \_\_\_\_\_

SERIAL NUMBER OF THE OPERATOR: \_\_\_\_\_

## beamUP Service

Owners are encouraged to register their product on [www.beamlabs.io](http://www.beamlabs.io)

Helpful product and troubleshooting information may be found online at [www.beamlabs.io](http://www.beamlabs.io)

Service number : 1-800-436-9186

Please have the following information when you call:

- Model number of the operator
- Serial number of the operator

# WARRANTY

Por la presente, el fabricante garantiza que al primer comprador (usuario) de este producto, en uso de la residencia en que fuera originalmente instalado:

1. Los operadores de la puerta de garaje responden por defectos de material y mano de obra por un periodo de un (1) año de la fecha de compra. El motor del modelo BU100 responde por defectos de material y mano de obra por un periodo de cinco (5) años de la fecha de compra. El motor de los modelos BU400 y BU800 responden por defectos de material y mano de obra por el total de vida del producto.

2. En el momento del reclamo de garantía, se debe entregar al fabricante la prueba de compra. Llama al 1-800-436-9186 antes de desmontar el producto.

3. El fabricante se reserva el derecho de modificar cualquier producto existente o futuro, sin incurrir en ninguna obligación de incorporar tal modificación a los productos que ya están fabricados o a los que pueda referir esta garantía.

4. La garantía sólo aplica si el producto ha sido instalado bajo las instrucciones del fabricante.

5. Esta garantía no aplica a ningún defecto, pérdida o daño derivados o causados de manera directa o indirecta por o como resultado de:

(i) Cualquier defecto (incluyendo los defectos en las partes componentes o accesorias) que surja de, o que sea atribuible a, la falta de la ejecución del mantenimiento preventivo normal o del ajuste del mismo.

(ii) Cualquier daño adicional o el deterioro que surja atribuible al hecho de que el operador la hace funcionar después de que se sabe que está defectuosa.

6. No están incluidos en la garantía:

(i) Pilas

(ii) Fusibles

(iii) Ajustes de sensibilidad

(iv) Los controles remotos manuales y el alcance del receptor

7. Tenga en cuenta que: todas las garantías estarán sujetas a:

(i) Los daños por agua y la condensación

(ii) El apagón del suministro de energía o sobretensión

(iii) Los desastres naturales

(iv) Las modificaciones y ajustes realizados por personas no autorizadas

(v) Cualquier interferencia de radio (incluyendo las radios de banda ciudadanas u otro dispositivo electrónico)

(vi) El no emprendimiento del mantenimiento preventivo y el servicio de mantenimiento regular

(vii) La cuenta no pagada en su totalidad por parte del comprador.

8. Sujeta únicamente a las disposiciones de la Ley de prácticas comerciales y de cualquier legislación del estado o territorio en el que los operadores del fabricante han sido vendidos o instalados (que pueden conferir ciertos derechos para los consumidores de bienes y esos derechos, por dicha legislación, pueden traducirse como imposibles de exclusión) esta garantía reemplaza y excluye todas las representaciones, garantías y condiciones ya sea expresas o implícitas por la ley y el fabricante no tendrá responsabilidad o de otro tipo distinto al que se ha establecido aquí por cualquier pérdida o daño (incluyendo pérdidas o daños consecuenciales,

# WARRANTY

pérdidas por el uso o ganancias) por razones de retraso, materiales o mano de obra defectuosos o en falta, negligencia o cualquier acto, hecho o cosa realizada que el fabricante permitida u omitida que se haga.

## **GARANTÍA**

ESTE FORMULARIO DE GARANTÍA DEBE LLENARSE EN EL MOMENTO DE LA INSTALACIÓN.

Este formulario de garantía lo debe conservar el comprador todo el tiempo y producir con la factura de compra el comprador como prueba de la fecha de compra.

NOMBRE DEL COMPRADOR: \_\_\_\_\_

DIRECCIÓN DEL COMPRADOR: \_\_\_\_\_

INSTALADO POR: \_\_\_\_\_

NÚMERO DE SERIE DEL OPERADOR: \_\_\_\_\_

## **SERVICIO**

Se recomienda a los propietarios que registren su producto en [www.beamlabs.io](http://www.beamlabs.io).

Ayuda e información sobre solución de problemas del producto se pueden encontrar en línea en [www.beamlabs.io](http://www.beamlabs.io)

Teléfono de Servicio 1-800-436-9186

Debe tener la siguiente información al momento de realizar la llamada:

- Número de modelo del operador
- Número de serie del operador

# SPARE PARTS

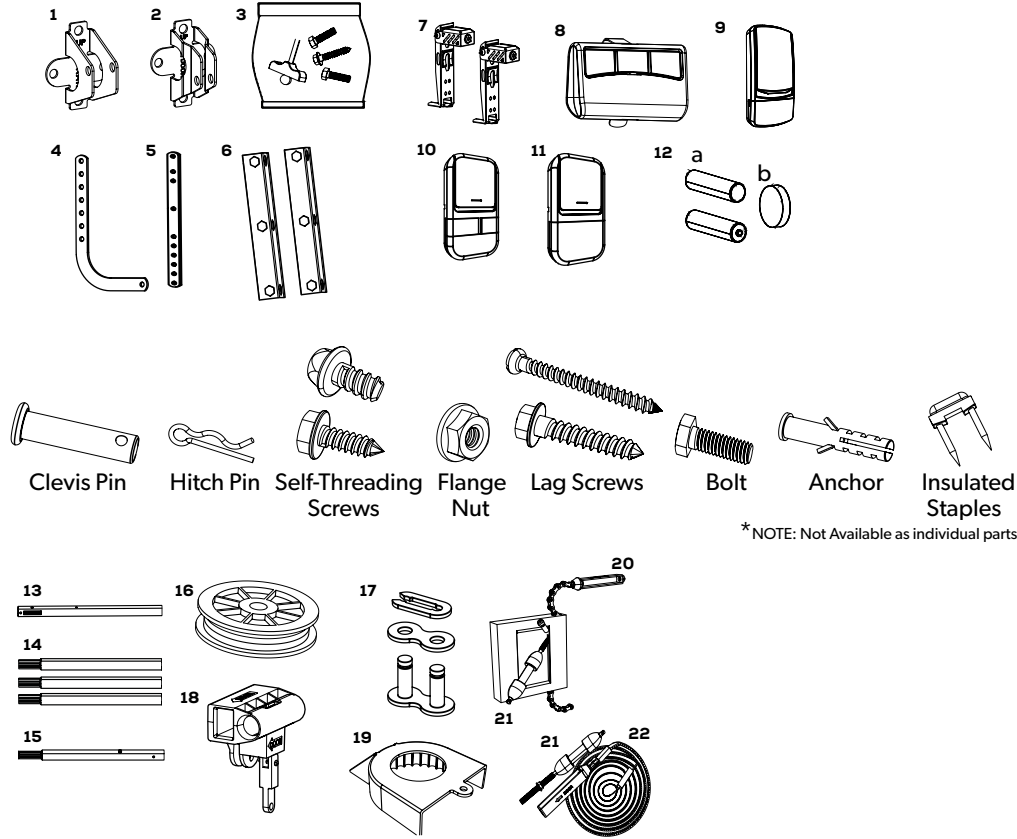

#	Name/Description	BU100	BU400	BU800	Nombre/Descripción
		Part # No. de parte	Part # No. de parte	Part # No. de parte	
INSTALLATION PARTS					
1	Header Bracket	RP-007	RP-007	RP-007	Soporte Cabecero
2	Door Bracket	GUAT-022	GUAT-022	GUAT-022	Soporte de la Puerta
3	Handle	RP-008	RP-008	RP-008	Bolsa de Instalación/Manija de Desconexión de Emergencia & Cuerda
4	Curved Door Arm	GUAT-024	GUAT-024	GUAT-024	Brazo curvo de la Puerta
5	Straight Door Arm	GUAT-025	GUAT-025	GUAT-025	Brazo recto de la Puerta
6	Hanging Bracket	RP-009	RP-009	RP-009	Soportes Estructurales
ACCESSORIES					
7	Photo Eye Safety System	GUAT-201	GUAT-201	GUAT-201	Sistema de Seguridad de Sensor óptico
8	Handheld Transmitter	R1BU	R3BU	R3BU	Transmisor Manual
9	Wireless Keypad			KPDBU	Teclado Inalámbrico
10	Deluxe Door Control		3FBU	3FBU	Control de Puerta de Lujo
11	Standard Door Control	1FBU			Control de Puerta Estándar
12	a. Wireless Keypad Battery			AAA	a. Batería Teclado Inalámbrico
	b. Remote Control Battery	CR2032 3V	CR2032 3V	CR2032 3V	b. Batería del Control Remoto
RAIL ASSEMBLY PARTS					
13	Rail-Header Segment	RP-001	RP-001	RP-001	Riel-Segmento de Cabecera
14	Rail-Middle Segment	RP-002	RP-002	RP-002	Riel-Segmento del Medio
15	Rail-End Segment	RP-003	RP-003	RP-003	Riel-Segmento Final
16	Pulley	GUT-840	GUT-840	GUT-840	Polea
17	Master Link Set	GUT-410	GUT-410	GUT-410	Conjunto de Enlace Principal
18	Trolley	RP-004	RP-004	RP-004	Carro
19	Sprocket Cover	RP-013	RP-013	RP-013	Cubierta de la Rueda Dentada
20	Chain	RP-006	RP-006		Cadena/Conector
21	Trolley Shaft & Cable/Trolley Shaft	RP-005	RP-005	RP-021	Eje del Carro & Cable/Eje del Carro
22	Belt			RP-014	Correa

# OPENER ASSEMBLY PARTS

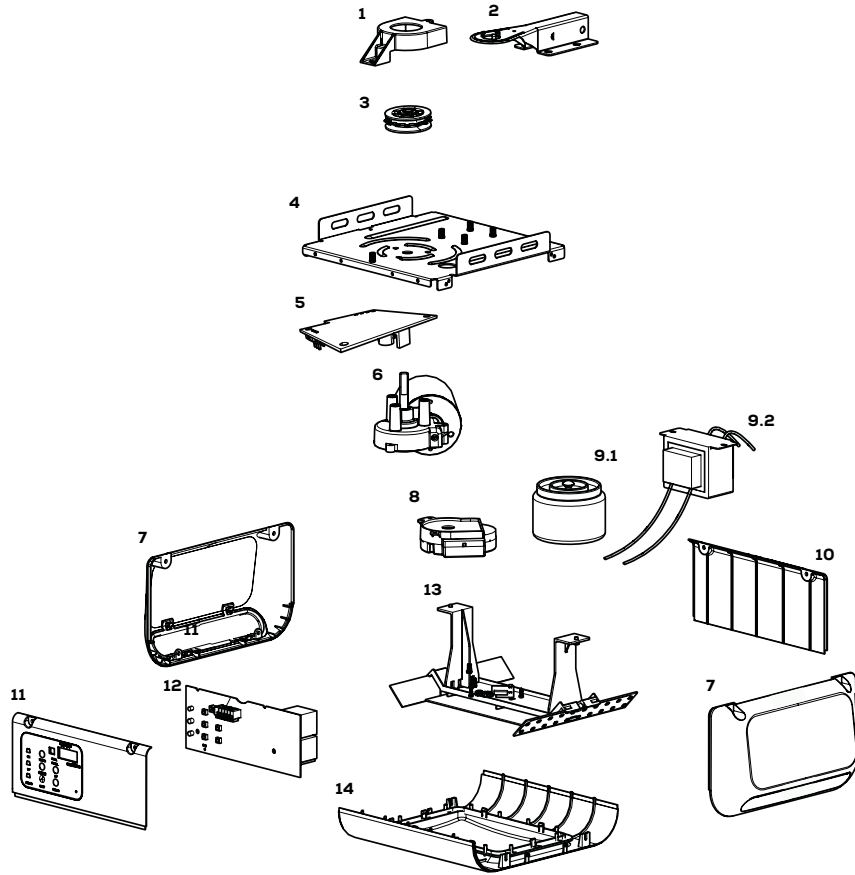

#	Name/Description	BU100	BU400	BU800	Nombre/Descripción
		Part # No. de parte	Part # No. de parte	Part # No. de parte	
	INSTALLATION PARTS				PARTES DE INSTALACION
1	Sprocket/Belt Pulley Cover	RP-013	RP-013	RP-013	Cubierta de la Rueda Dentada
2	Rail Bracket	RP-018	RP-018	RP-018	Soporte del Riel
3	Sprocket/Pulley	RP-019	RP-019	RP-034	Rueda Dentada
4	Chassis	N/A	N/A	N/A	Chasis
5	Power Module LED	RP-349	RP-350	RP-350	Módulo de Potencia LED
6	Motor	GU DT-313	GU DT-313	GU DT-305	Motor
7	Side Panels	RP-346	RP-347	RP-347	Paneles Laterales
8	Position Encoder	GU DT-314	GU DT-314	GU DT-314	Codificador de Posición
9	Transformers (9.1/9.2)	GU DT-315	GU DT-315	GU DT-302	Transformadores (8.1/8.2)
10	Cover Plate - Front	RP-341	RP-341	RP-341	Placa de Cubierta - Frente
11	Cover Plate - Back	RP-342	RP-342	RP-342	Placa de Cubierta - Trasero
12	Logic Board	RP-343	RP-343	RP-343	Receptor/Tablero Lógico
13	LED Cluster				LED
13.1	LED Cluster, Center	RP-344	RP-344	RP-344	LED, Central
13.2	LED Cluster, Side (2)		RP-348	RP-348	LED, Lateral (2)
14	Lamp Dome	RP-345	RP-345	RP-345	Cúpula de Lampara