



# Sliding Gate Opener

## User's Manual

**Model:**

**RK2600(T)**

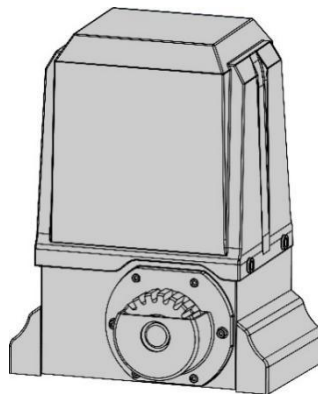

TOPENS Website

[www.topens.com](http://www.topens.com)

- ★ Please read and follow all warnings, precautions and instructions before installation and use.
- ★ Periodic checks of the opener are required to ensure safe operation.
- ★ Save this manual.

**⚠ Warning:** A photocell sensor is included in the package. The photocell must be installed with the gate opener for **SAFETY PROTECTION**. The jumper wire between the PHO & COM terminals (NO.14 & NO.15) **MUST BE REMOVED** before installing the photocell.

Email: [support@topens.com](mailto:support@topens.com)



# CONTACT US:

Visit: [www.topens.com](http://www.topens.com)

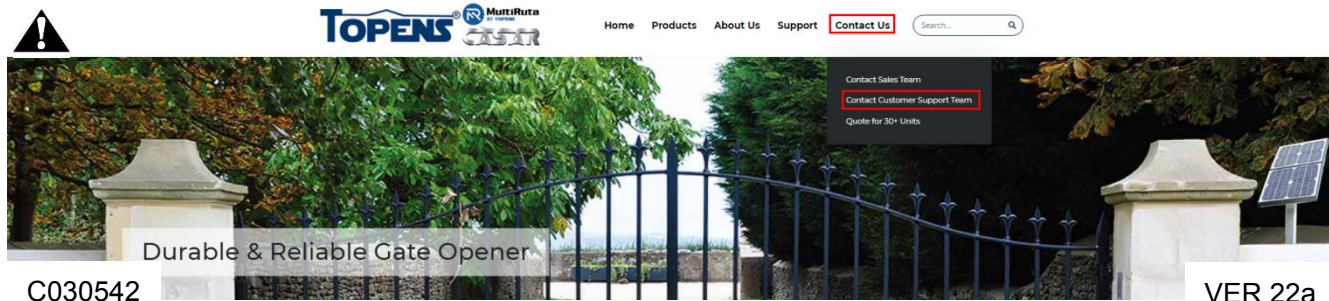

**Please record the product model, your email address etc.  
in the spaces provided below. Refer to this list when contacting TOPENS  
for technical service or assistance with your automatic gate opener.**

Where did you purchase? (Amazon.com; Amazon.ca; Amazon.co.uk, Amazon.de; Other, Please Specify)

<b>Order#</b>	<b>Product Model</b>	<b>Purchase Date</b>
<b>Full Name</b>	<b>Phone#</b>	<b>Email Address (VERY IMPORTANT)</b>
<b>Street Address, Apartment /Unit, City, State /Province, Zip Code</b>		<b>Country/Region</b>
<b>Approximate Gate Weight (pounds; kg: Other. Please Specify)</b>	<b>Approximate Gate Length (feet; meter; Other. Please Specify)</b>	<b>Did you purchase any accessories? (Please list below)</b>
<b>Issue Details</b>		

**Email Us: [support@topens.com](mailto:support@topens.com)**

**Call: +1 (888) 750 9899 (Toll Free USA & Canada)**

# Table of Contents

Check Your Gate before Installation .....	1
General Safety .....	1
Preparation for Installation .....	2
Parts List .....	4
Accessories Parts (Included in some models, refers to the actual package) .....	4
Optional Accessories Parts List (Available at TOPENS Store) .....	5
Replacement Parts .....	5
Technical Specifications & Features .....	6
Installation Overview .....	6
Installation of the Opener .....	7
Manual Operation .....	7
Fit the Rack .....	8
Install the magnets for Limit Switches .....	8
Connecting of Power Supply .....	9
Connecting of the Control Board .....	9
Setting of the Control Board .....	11
How to Program or Erase the Remote .....	12
How to Use the Remote to Operate Your Gate Opener .....	13
Wireless Keypad Programming .....	13
Troubleshooting .....	14
Maintenance .....	15

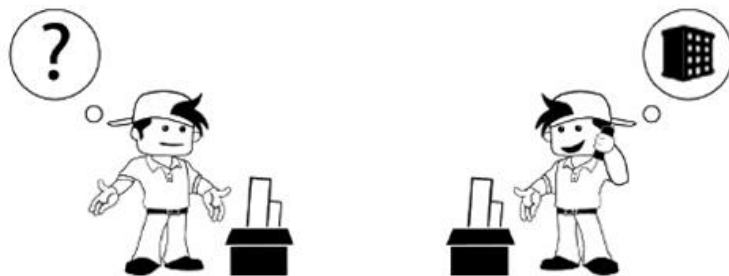

**i** Ask for TOPENS help by E-mail or phone anytime.

Thank you for purchasing sliding gate opener. We are sure that the products will be greatly satisfying as soon as you start to use it.

The product is supplied with a user's manual which encloses installation and safety precautions. These should be read carefully before installation and operation as they provide important information about safety, installation, operation and maintenance. This product complies with the recognized technical standards and safety regulations.

## Check Your Gate before Installation

### CHECK YOUR GATE

Before installation, please make sure that the gate itself can be opened and closed smoothly & freely BY HAND WITHOUT THE GATE OPENER.

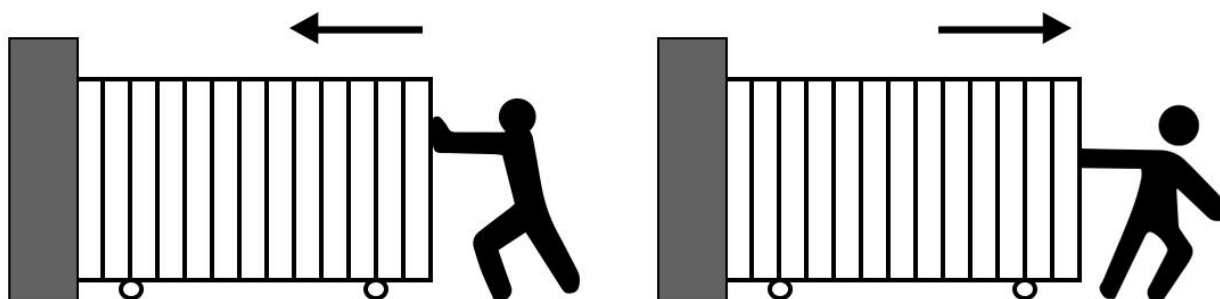

## General Safety

**⚠ WARNING!** An incorrect installation or improper use of the product can cause damage to persons, animals or properties.

- Scrap packing materials (plastic, cardboard, polystyrene etc.) according to the provisions set out by current standards. Keep nylon or polystyrene bags out of children's reach.
- This product was exclusively designed and manufactured for the use specified in the present documentation. Any other use not specified in this documentation could damage the product and be dangerous.
- The factory declines all responsibility for any consequences resulting from improper use of the product, or use which is different from that expected and specified in the present documentation.
- Do not install the product in explosive atmosphere.
- The factory declines all responsibility for any consequences resulting from failure to observe Good Technical Practice when constructing closing structures (door, gates etc.), as well as from any deformation which might occur during use.
- Disconnect the electrical power supply before carrying out any work on the installation. Also disconnect any buffer batteries, if fitted.
- Fit an omnipolar or magnetothermal switch on the mains power supply, having a contact opening distance equal to or greater than 3,5 mm.
- Make sure a residual current circuit breaker with a 30mA threshold is fitted before the power supply mains.
- Check that earthing is carried out correctly: connect all metal parts for closure (doors, gates etc.) and all system components provided with an earth terminal.
- Fit all the safety devices (photocells, electric edges etc.) which are needed to protect the area from any

danger caused by squashing, conveying and shearing.

- Position at least one visible indication device (Alarm lamp), and fix a Warning sign to the structure.

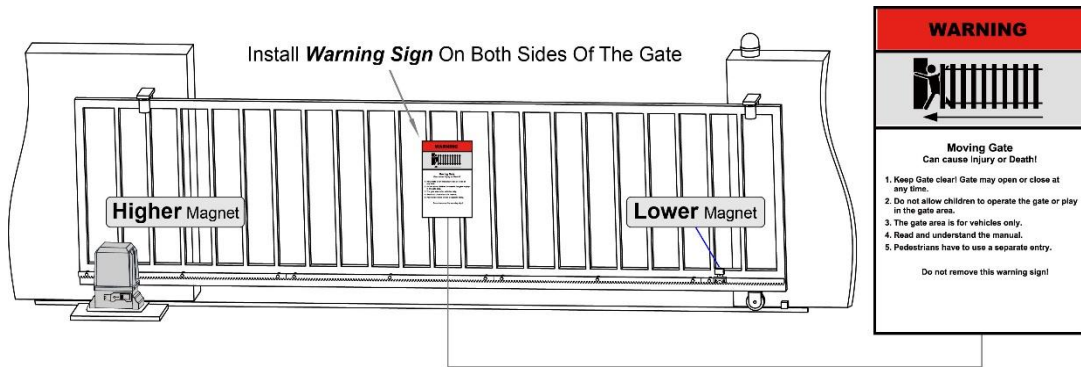

- The factory declines all responsibility with respect to the automation safety and correct operation when other supplier's components are used.
- Only use original parts for any maintenance or repair operation.
- Do not modify the automation components, unless explicitly authorized by the factory.
- Instruct the product user about the control systems provided and the manual opening operation in case of emergency.
- Do not allow persons or children to remain in the automation operation area.
- Keep radio control or other control devices out of children's reach, in order to avoid unintentional automation activation.
- The user must avoid any attempt to carry out work or repair on the automation system, and always request the assistance of qualified personnel.
- Anything which is not expressly provided for in the present instructions is not allowed.
- Before installing the gate opener, check that all moving part as well as the sliding gate is in good mechanical condition, correctly balanced and opens and closes properly.
- Save these instructions for future use.

## Preparation for Installation

Before proceeding to your opener installation, check if your gate structure is in accordance with the current standards, especially as follows:

The gate sliding track is linear and horizontal. The wheels are suitable for use. The gate should be mounted and moved freely. Check that the structure is sufficiently strong and rigid, and that its dimensions and weights conform to those listed in the specifications table of this document. Make sure that the gate is plumb and level. The fence posts must be mounted in concrete. The gate does not bind or drag on the ground.

- The gate manual operation can be carried out smoothly along its entire run, and there is no excessive side slipping.
- The opening and closing gate stops are positioned.



**WARNING:** Remember that control devices are intended to facilitate gate operation, but can not solve problems due to any defects or deficiency resulting from failure to carry out correct installation or maintenance. Take the product out of its packing and inspect it for damage. Should it be damaged, contact your dealer. Remember to dispose of its components (cardboard, polystyrene, nylon, etc.) according to the current prescriptions.

**Refer to the following Figures for gate installation.**



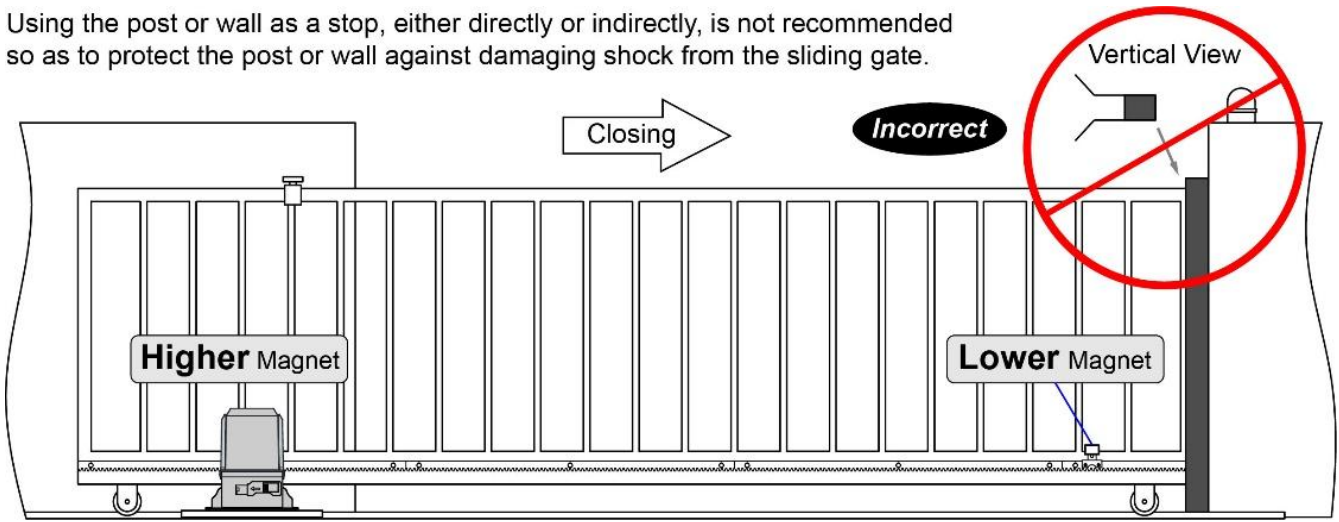



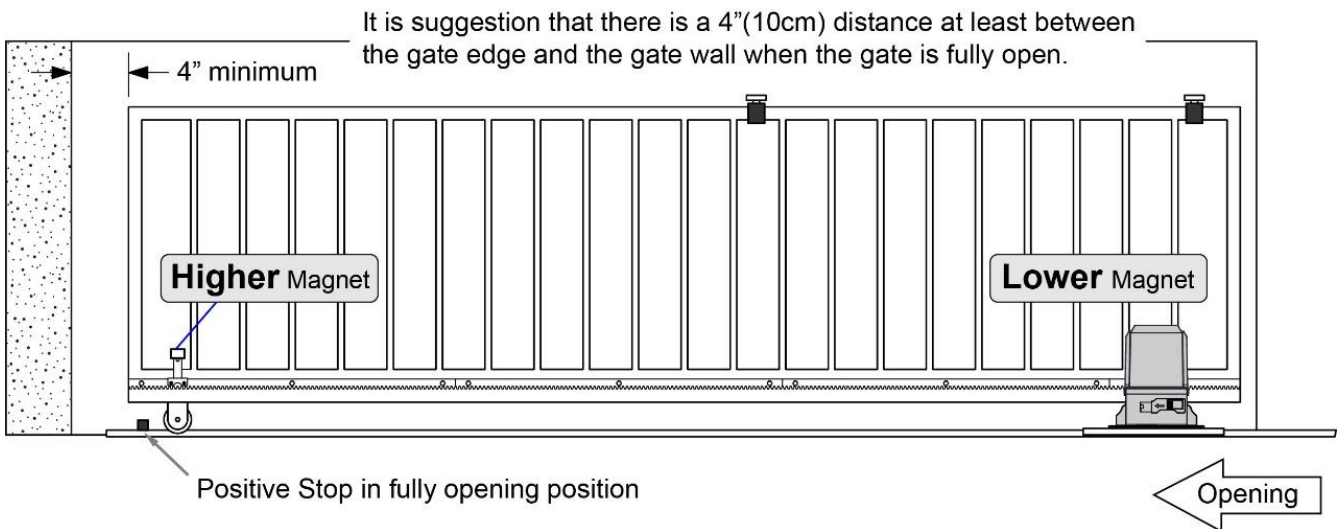
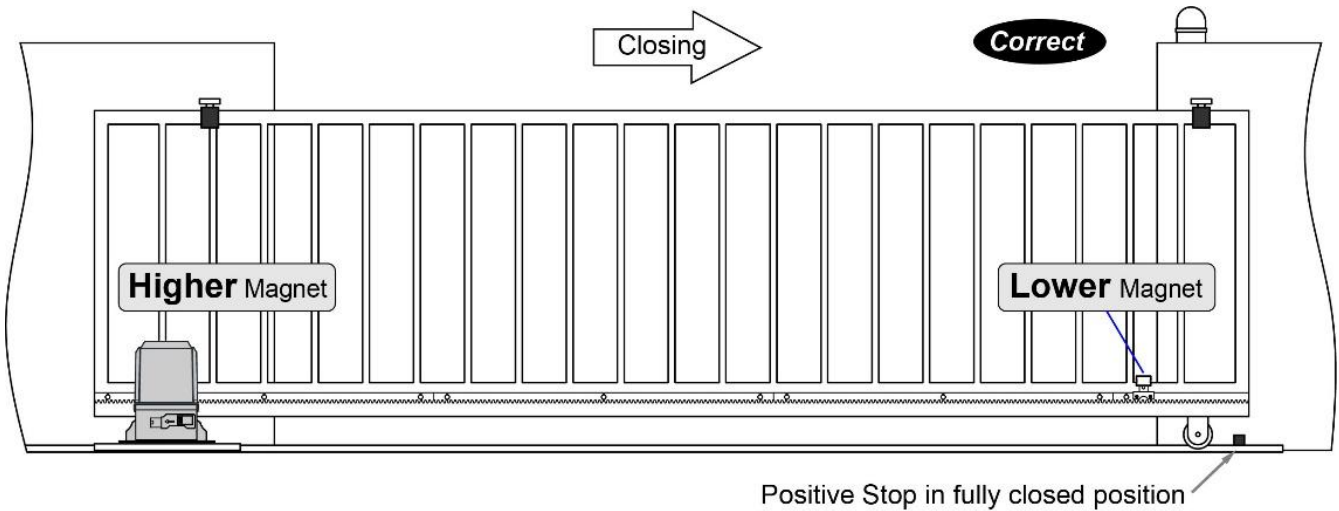

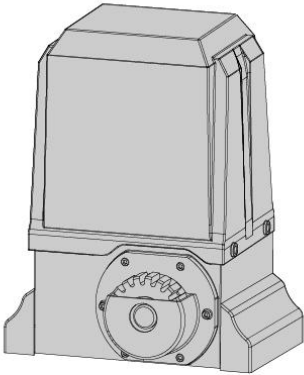

Using the post or wall as a stop, either directly or indirectly, is not recommended so as to protect the post or wall against damaging shock from the sliding gate.



In sake of safety, a positive stop must be mounted on the two end of ground track.





## Parts List

 <p>Gate Opener (1 pc)</p>	 <p>Release Key (2 pcs)</p>	 <p>Anchor Bolt (4 pcs)</p>	 <p>Warning Signs (2 pcs)</p>
 <p>Higher Magnet bracket (1 pc)</p>	 <p>Lower Magnet bracket (1 pc)</p>	 <p>M10 Nut (8 pcs)</p>	 <p>Long Washer (2 pcs)</p>
 <p>Pan Head Screw M5×10 (8 pcs)</p>	 <p>Plain Washer <math>\phi</math> 10 (8 pcs)</p>	 <p>Magnet Assembly Blue (2 pc)</p>	

## Extra Parts for RK2600T

 <p>Steel Rack (12pcs total 4.2m) (Included in T Series)</p>
---

## Accessories Parts (Included in some models, refers to the actual package)

 <p>JD110VY / JD230VY AC Warning Light</p>	 <p>TC102 Photo Eye Beam Sensor</p>
---	--

## Optional Accessories Parts List (Available at TOPENS Store)

 <p>M12 Remote Control</p>	 <p>ERM12 External Receiver</p>	 <p>TC186-R WiFi Smartphone Remote Control with Camera</p>	 <p>TC188 Universal Wireless and Wired Keypad</p>
 <p>TKP3 Wireless Keypad</p>	 <p>TC175P Wired Keypad</p>	 <p>TEW3 Vehicle Sensor Exit Wand</p>	 <p>HLR01 HomeLink Remote Control Kit</p>
 <p>TC173 Wireless Push Button</p>	 <p>TC147 Wall Push Button</p>	 <p>TC148 Waterproof Wall Push Button</p>	 <p>TRF3 Reflection Photocell Sensor</p>
 <p>TC102 Photo Eye Beam Sensor</p>	 <p>JD110VY / JD230VY AC Warning Light</p>	 <p>SR02 Heavy Duty Steel Gear Rack</p>	

## Replacement Parts

 <p>ACPYMJ2B-JCQ Control Board</p>	 <p>CKG50A Limit Switch</p>
---	--

**WARNING:** Changes or modifications not expressly specified by this user manual, TOPENS could void the warranty of this equipment.



## Technical Specifications & Features

<b>Specifications</b>	
	RK2600(T)
Power supply:	110V~120V/60Hz or 220~240V/50Hz
Motor voltage:	120VAC or 230VAC
Absorbed power:	1000W
Gate moving speed:	20 cm/s (8 in/s)
Max gate weight:	2600kg (5700lbs)
Max torque:	75Nm
Environmental conditions:	-20°C ~ +50°C (0°F to 120°F)
Protection class:	IP44

### Features:

- Easy to install, and minimum maintenance requirement
- Midway mode
- Quick selection for gate open/close direction
- Reliable rolling code technology for remote control
- Emergency release key in case of power failure
- Reverse in case of photocell beam obstruction

during gate closing

- Built in adjustable auto-closing (0, 30, 60, 90 seconds)
- Built in max. Motor Running Time (MRT) for multiple safety protection (90 seconds)
- Reliable electromagnetism limit for easy adjustment
- Can be equipped with wide range accessories

## Installation Overview

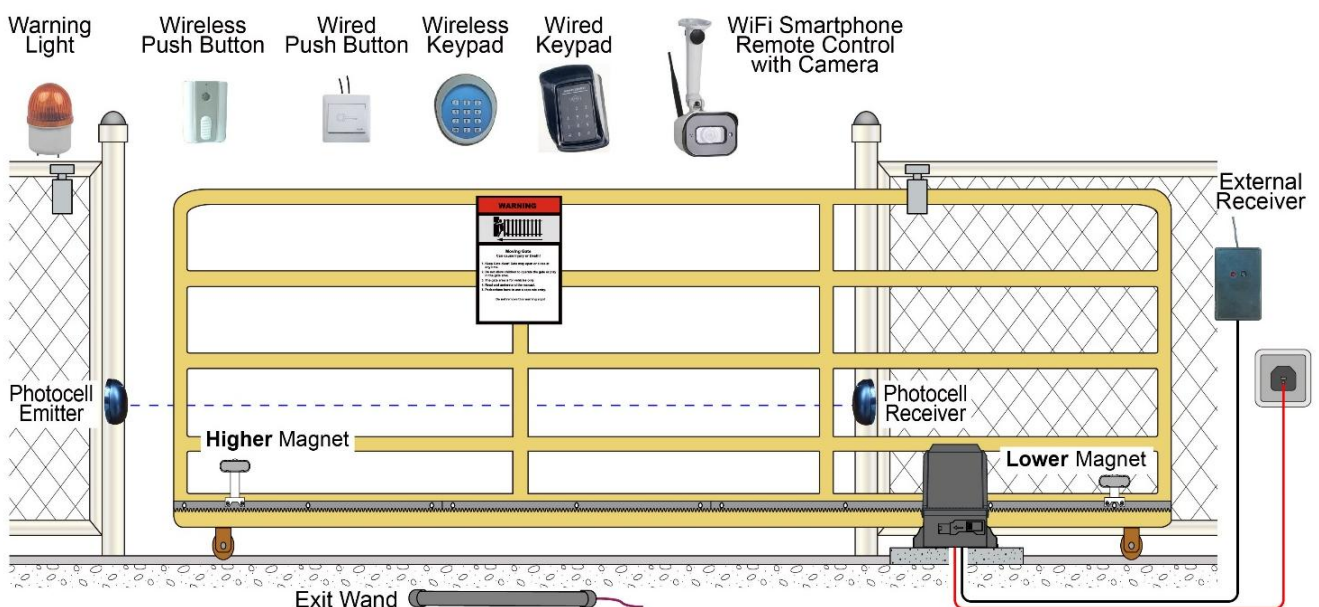

# Installation of the Opener

### Caution:

\*Be sure that the opener is installed in a level and paralleled position and is properly secured. Improper installation could result in property damage, severe injury, and/or death.

\* Before starting installation, ensure that there is no point of friction during the entire movement of the gate and there is no danger of derailment.

\* Ensure that the safety side panels are present.

**Necessary Tools:** The following tools may be necessary to install the Gate opener. You will need screwdrivers, an electric drill, wire cutters and a wire stripper, a socket set, and possibly access to a welder.

When install the opener, you should build a concrete pad to support the base plate of opener in order to maintain proper stability.

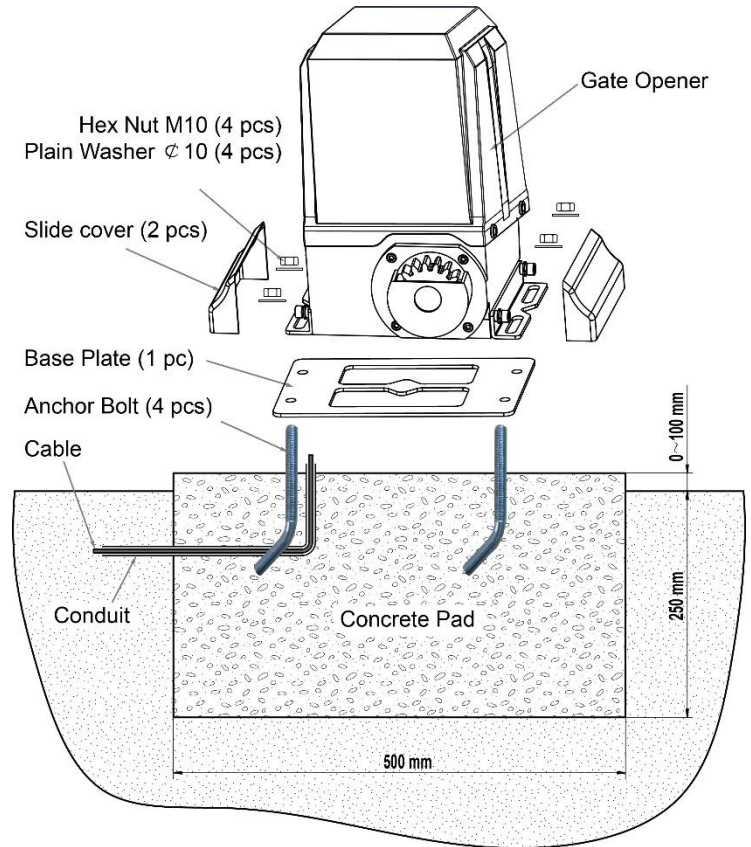

### The installation proceeds are as follows:

1. Dig a hole for a concrete pad which should be approximately 47 x 40 x 35cm (18.5" x 16" x 14" ). It may protrude 10 cm (4") above ground and 25 cm (10") in depth underground. Increase the pad height if necessary to protect the system from flooding, heavy snow etc.
2. Prepare one or more conduits for the electrical cables before pour concrete. Remember that cable conduits have to pass through the hole in the base plate.
3. Pour concrete and before it starts to harden, check that it is parallel to the gate leaf and perfectly level.
4. The four anchor bolts must be set into the concrete when it is poured, make sure the position of anchor bolts was placed according to the position of mounting holes on the base plate before concrete become harden.
5. Mount the base plate to the concrete Pad. It's only temporary installation. Further adjustment will be required when install the chain.

# Manual Operation

The opener should be put in the manual (emergency release) position before fitting the chain, installing the opener and limit switch. The process is as follows:

- 1) Push the cover in arrow direction, now the key slot appears.
- 2) Insert release Key into the key slot and turn it in counter-clockwise 90° to disengage the clutch between the gear shaft and power output. Now the opener is in the manual operation.

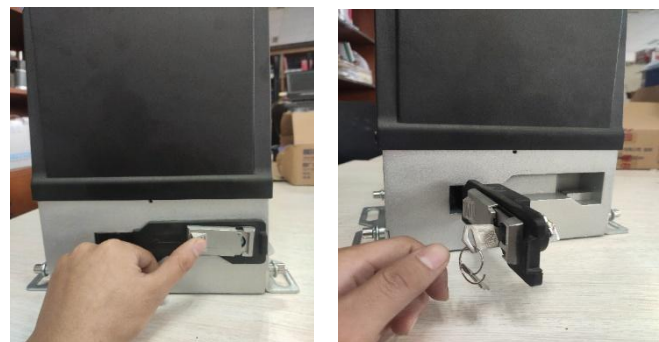

## Fit the Rack

### Fit the galvanized steel rack

1. Start with gate in closed position
2. Prepare the gear rack (you can order extra rack from dealer if necessary).
3. Put one end of rack section on the gear of opener as a temporary support. Make rack level and mark the rack's mounting holes (three holes) on the gate.
4. Weld the rack nut on the gate as mark and connect the rack to the gate using the bolt provided. Before weld, please keep 1.0mm space between the rack and the gear to avoid the weight of the gate leaf effect on the opener.

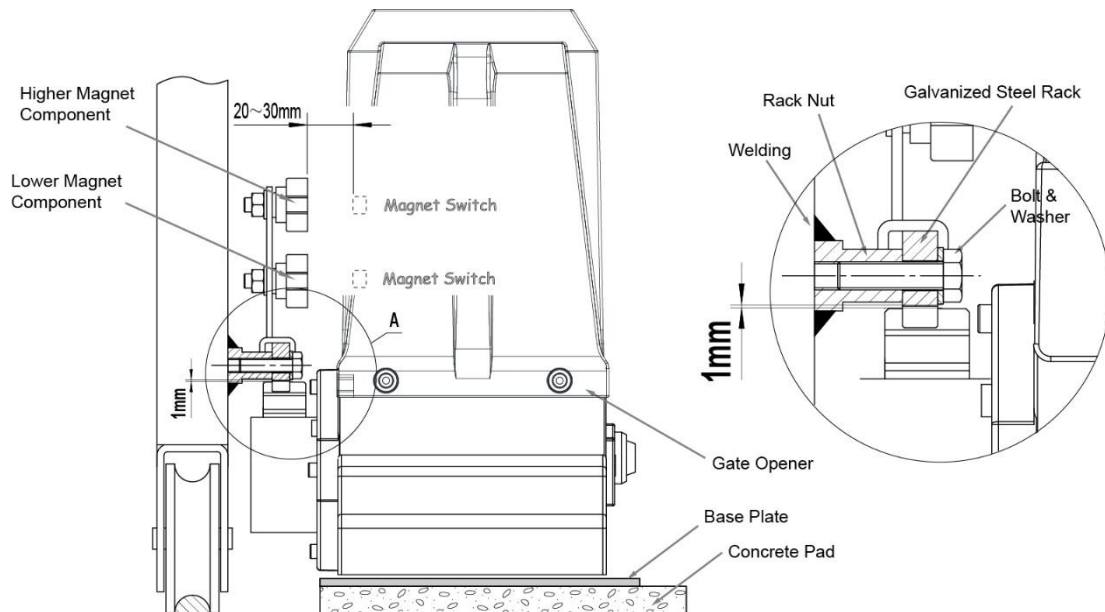

### Important:

1. Adjust opener's height by using **long washer** if necessary.
2. Check that the rack teeth must engage the gear teeth throughout their full thickness. If not, adjust the position of the opener or/and place a few shims between the rack and gate.
3. Manually slide the gate leaf to ensure the rack is proper on the gear of opener, weld the second nut.
4. Repeat same steps of first rack section to install the rest rack sections until proper length is reached.
5. Cut away any excess of the rack (Note: rack length must be longer than actual travel of the gate to accommodate limit switch brackets on each gate side.)
6. Thoroughly fasten the four nuts as well as spring washers onto expansion bolt tightly, enabling the opener is firmly secured on the concrete pad during the whole gate travel.

## Install the magnets for Limit Switches

Before install limit switch, make sure the gate opener is put in manual operation. (the clutch connected with gear shaft is disengaged) and the mains power supply is disconnected.

Position the two limit stop brackets approximately on the rack and move the gate by hand to fix them in place.

### Fit magnets bracket

Push the gate fully closed by hand. Locate and install the magnet bracket so that the opener will stop at the desired close position when the close limit switch approaches it.

Push the gate fully open by hand. Locate and install the magnet bracket so that the opener will stop at the desired open position when the open limit switch approaches it.

The higher magnet bracket must be installed at left side and lower magnet bracket must be installed at right side from the view inside of property. Finally adjust the magnet to the proper position by moving the gate with the motor. **The magnet should be 20-30mm (0.8-1.2") away from the magnetic limit switch.** If it is too far away, the switch will fail to work. The distance between the magnet and the opener should be 10-15mm with the opener cover on. Adjust the position of the magnet until the positions of the opening and closing meet the requirement.

**Important Note:** Please note the two magnet brackets (fixed plate) are different: one is higher and the other is lower.

◆ **Warning: Improper magnets installation may cause the gate crash into end barrier, which is very dangerous !**

## Connecting of Power Supply

**⚠ WARNING: NEVER connect the gate opener to the power outlet before all the installations have been done.**

The power supply cord should be at least 3×2mm<sup>2</sup> (3C×14AWG). Connect the live wire and neutral wire to the “L” (1#) and “N” (3#) terminal of the control board respectively; and connect the earth wire to “GR” (2#) terminal of the control board.

**NOTE:** The power supply cord is not included in the package.

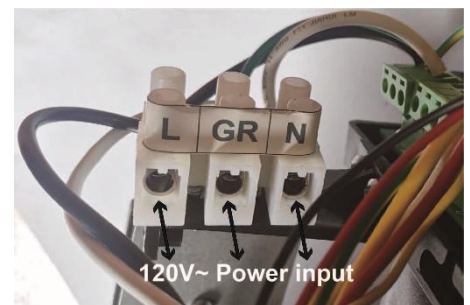

## Connecting of the Control Board

**⚠ Warning:** Before making any electrical wire connection or/and setting the control board, make sure that the power switch is OFF.

**⚠ Warning:** A photocell sensor is included in the package. The photocell must be installed with the gate opener for SAFETY PROTECTION. The jumper wire between the PHO & COM terminals (NO.14 & NO.15) MUST BE REMOVED before installing the photocell.

### 1. Contactors

The **A1** terminal of both contactors should be wired to the “6” terminal of the control board.

The **A2** terminal of contactor1 should be connected into the “8” terminal the control board.

The **A2** terminal of contactor2 should be connected into the “7” terminal the control board.

### 2. Limit Switches

The **RED** wire of the limit switches should be connected into the “9” terminal.

The **BLACK** wire of the limit switches should be connected into the “10” terminal.

The **YELLOW** wire of the limit switches should be connected into the “11” terminal.

### 3. Warning Light (Included in some models, refers to the actual package)

One wire of the warning light should be connected into the “4” terminal, another should be connected into the “5” terminal.

### 4. Photocell Beam System (PBS) (Normally Closed)

Use a 2-core cable to connect the “+ ~” terminal of the photocell’s emitter to the “12” terminal, the “- ~” terminal to the “13” terminal. Also the “+ ~” and “- ~” terminals of the photocell’s receiver should be connected to the “12” and “13” terminals in parallel.

Use another 2-core cable to connect the “**NC**” terminal of the receiver to the “14” terminal, the “**COM**” terminal to the “15” terminal.

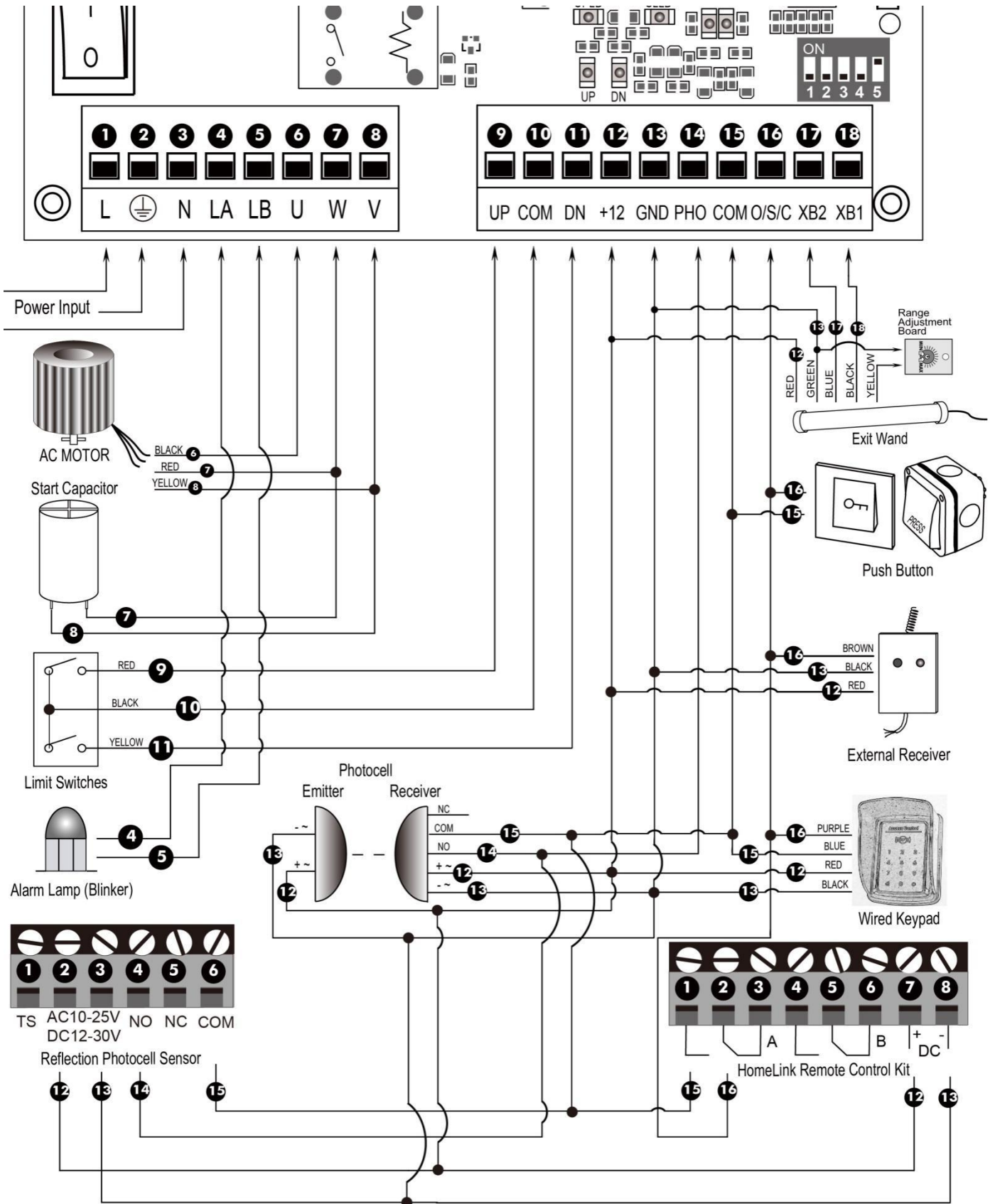

### 5. Reflection Photocell Sensor (optional)

The “AC10-25V/DC12-30V” terminals of the reflection photocell sensor should be connected to the “12” and “13” terminals, no matter the polarity.

The “NO” terminal should be connected to the “14” terminal.

The “COM” terminal should be connected to the “15” terminal.

### 6. Push Button (Optional)

The push button should be wired to the “15” and “16” terminals. The gate opener works alternately by pushing the button (open-stop-close-stop-open).

### 7. Exit Wand (Optional)

First insert the **Adapter BOARD** into the **CONTROL BOARD**, and then connect the wand to the control board refers to following instruction.

The **BLACK** wire of the exit wand should be connected into the “#18” terminal.

The **BLUE** wire of the exit wand should be connected into the “#17” terminal.

The **RED** wire of the exit wand should be connected into the “#12” terminal.

The **GREEN** wire of the exit wand should be connected into the “#13” terminal.

The sensitivity adjustment board should be wired to the **GREEN** wire and the **YELLOW** wire of the wand. No matter the polarity.

### 8. External Receiver (Optional)

The **BROWN** wire of the external receiver should be connected into the “16” terminal.

The **BLACK** wire of the external receiver should be connected into the “13” terminal.

The **RED** wire of the external receiver should be connected into the “12” terminal.

### 9. Wired Keypad (12VDC) (Optional)

The **RED** wire of the wired keypad should be connected into the “12” terminal.

The **BLACK** wire of the wired keypad should be connected into the “13” terminal.

The **PURPLE** wire of the wired keypad should be connected into the “16” terminal.

The **BLUE** wire of the wired keypad should be connected into the “15” terminal.

### 10. HomeLink Remote Control Kit (optional)

The “1” terminal should be connected to the “15” terminal.

The “2” terminal should be connected to the “16” terminal.

The “DC+” terminal should be connected to the “12” terminal.

The “DC-” terminal should be connected to the “13” terminal.

## Setting of the Control Board

**⚠ WARNING:** Ensure the gate opener is Power Off when you make any adjustment of the gate opener. Keep away from the gate during you set the gate opener system in case of the unexpected gate moving. Carefully adjust the DIP switches to avoid the risk of machine damage and injury or death. Always ask the help of professional technician /electrician if you have any question.

### 1. DIP Switches

The DIP switches are used to set the running time of the motor in midway mode, auto close time of the gate opener and fast change the open/close direction which is determined by the position of the gate opener installed.

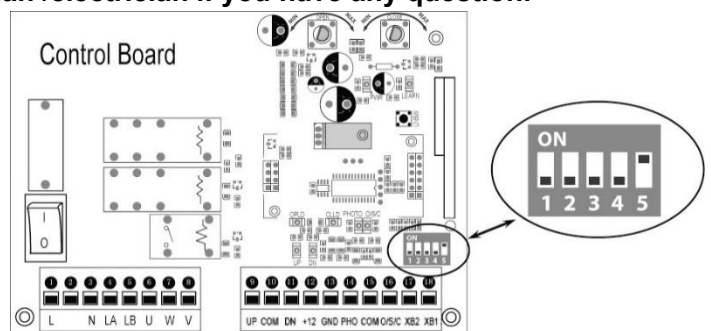

### DIP Switch #1–#2: Running time of the motor in Midway Mode

This mode enables user to drive the vehicle through the gate quickly when the gate opens to certain width.

**DIP Switch #1:** ON – 4 Seconds OFF – 0

**DIP Switch #2:** ON – 2 Seconds OFF – 0

**NOTE:** The midway mode function would be disabled if both DIP switches are turned off. Factory default setting is disabled. The midway mode could be activated by pressing button B of the remote control when the gate is in the full closed position.

E.g.  → Running time of the operator in midway mode is 4+2=6 seconds.

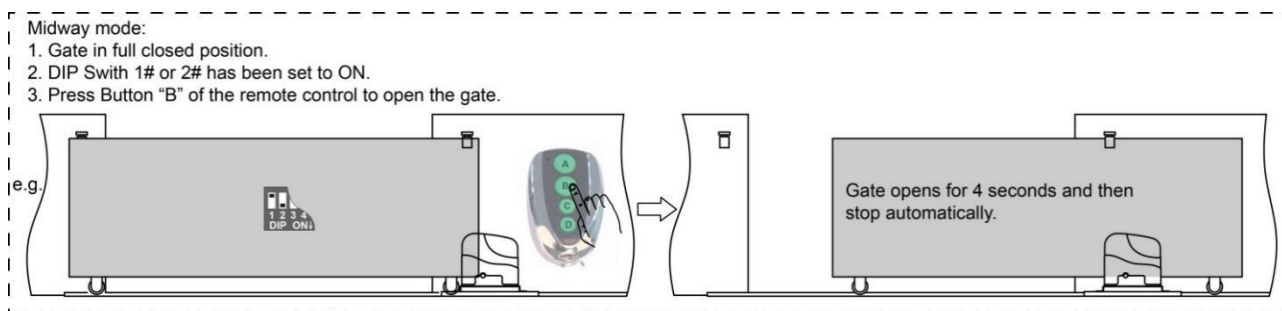

### DIP Switch #3–#4: Auto close time of the gate opener

DIP Switch #3: ON – 30 Seconds OFF – 0

DIP Switch #4: ON – 60 Seconds OFF – 0

**NOTE:** The auto close function would be disabled if both dip switches are turned to off (factory default setting).

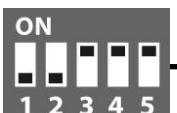
E.g.  → Auto close time of the gate operator is 30+60=90 seconds.

### DIP Switch #5: Left/Right open

ON – Left open (factory default setting).

OFF – Right open. Turn switch OFF to change the opening direction easy if necessary.

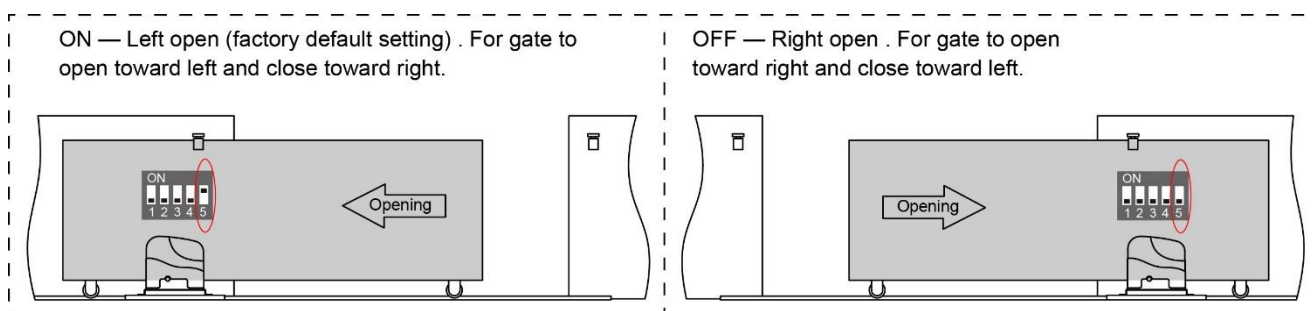

## How to Program or Erase the Remote

- ✧ **The remote MUST be programed to the opener BEFORE OPERATING. Please follow the steps to program the remote.**
- ✧ **Activate the opener only when gate is in full view, free of obstruction and properly adjusted. No one should enter or leave gate area while gate is in motion. DO NOT ALLOW CHILDREN to operate push button or remote. DO NOT ALLOW CHILDREN TO PLAY NEAR THE GATE.**
- ✧ **If you purchase additional remote controls, the gate opener must be programmed to accept the new remote code.**
- ✧ **If you lose one of any remote control, please erase and reprogram all other remote controls to have a new code for safety.**

### Program the remote

Press and release the learn button, the **REM LED** light will be on, then press the key on the remote

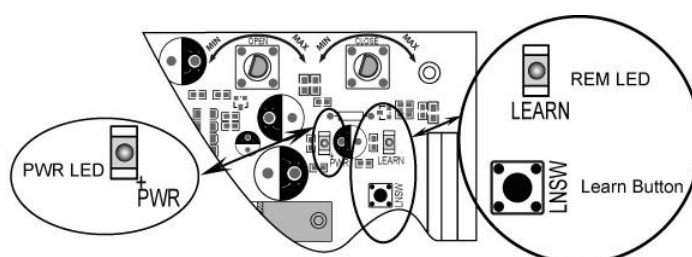

**two times** in 2 seconds, **between the two times HOLD ON FOR A MOMENT**, the **REM LED** light will flash for 4 seconds. Now the remote has been programmed successfully.

### Erase all the remote codes

Press and hold the learn button until the **REM LED** light is off. Now all remote codes have been erased.

- ✧ **NOTE: Max. 8 remotes can be programmed for the opener. An External Receiver (optional) allows up to 250pcs remotes to be programmed for the opener. TOPENS ERM12 Universal External Receiver is available at TOPENS Store.**
- ✧ **TOPENS ERM12 Universal External Receiver is also compatible with other brand swing gate opener, sliding gate opener and garage door opener.**

## How to Use the Remote to Operate Your Gate Opener

Each remote has four buttons, from top to bottom are separately A, B, C and D. You may use this remote to operate as many as 4 sets TOPENS swing gate openers or 1 set TOPENS sliding gate opener and 2 sets TOPENS swing gate openers.

1. Use this remote to only operate TOPENS swing gate opener A, B, C and D four buttons share same function once they are programmed with TOPENS swing gate opener. You may choose any button to program it with our swing gate opener. Every press of the button is able to active the gate opener to work alternately (open-stop-close-stop-open).

2. Use one remote to operate TOPENS swing gate opener & sliding gate opener at the same time

All of TOPENS sliding gate opener have midway mode. Button B is designed to realize midway function (refer to more details in our TOPENS sliding gate opener manual). So it is must program button A with sliding gate opener, while you may program either C button or D button with TOPENS swing gate opener.

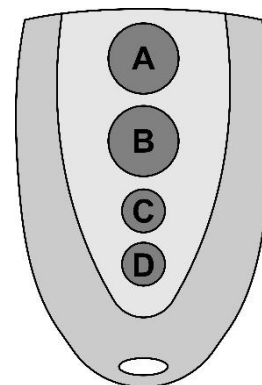

## Wireless Keypad Programming

You can follow the below steps to program wireless keypad to the opener. Press the **LNSW** button until the **REM LED** is ON, and then releases the button. Then press "OK" button on keypad and **REM LED** will flash for 3 seconds and then be OFF which indicates the keypad has been programmed successfully. You can use the default password "888888" to operate the opener after programming. You can press "PIN" "8 8 8 8 8 8" and then press "OK" to confirm to operate the opener.

Also you can change the password of the keypad follow the below steps. Press "PIN" and then input the six digits old password and then press "PIN" again, the **REM LED** will be ON. Input the six digits new password and then press the "PIN" to confirm the new setting, **REM LED** will flash for 3 seconds and then be OFF which indicates the password has been changed successfully. You can press "PIN" "6 digits new password" and then press "OK" to confirm to operate the opener.



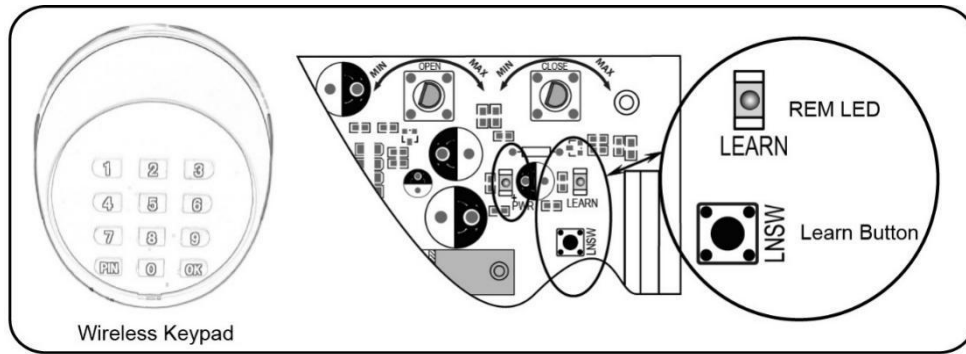

**NOTE:** Every step for pressing button during program must be finished within 1 second to ensure successful programming.

## Troubleshooting



**Need help or have questions? DO NOT RETURN to the store.**  
**Visit [www.topens.com](http://www.topens.com) to CONTACT US.**

Have a multi-meter to check voltage and continuity. Use caution when checking high voltage terminals.

Symptom	Possible Solution(s)
The opener does not run. Power LED is OFF.	<ol style="list-style-type: none"> <li>1. Check the input voltage of the control board. It should be local AC electricity.</li> <li>2. The power switch is OFF. Make sure the power switch is ON.</li> <li>3. Check the fuse in the control board. Replace the fuse if it was burnt out.</li> <li>4. Check the control board. Replace the control board as necessary.</li> </ol>
The opener does not run. Power LED is ON.	<ol style="list-style-type: none"> <li>1. Ensure the remote control has been programmed to the control board before operating.</li> <li>2. The thermal protector is working because the high temperature after long working time. Please wait for 20 minutes to let the motor become cold.</li> <li>3. Check the installing position of the magnets. The opener would not run if both of the limit switches are activated by one magnet.</li> <li>4. Check the limit switch. Remove the wire connection of the limit switch which is connected to the 9#, 10#, and 11# terminals of the control board and then try it again. Replace the limit switch if the motor could run in both directions.</li> <li>5. Check the control board. Replace the control board as necessary.</li> </ol>
Remote control does not work.	<ol style="list-style-type: none"> <li>1. The indicator light of remote control is not on. Check the battery in your remote control. Replace the battery as necessary.</li> <li>2. The distance you use the remote is too far away from the opener. Try it again closer.</li> <li>3. Remote control is not suitable for receiver. After making sure the codes are</li> </ol>

	<p>correct, erase remote controls and then re-program the codes in the device.</p> <p>4. Check the control board. Replace the control board as necessary.</p>
<p>The gate opens, but stops and will not return.</p>	<p>1. Check the installing position of the magnets. The opener would not run if both of the limit switches are activated by one magnet.</p> <p>2. Check the limit switch. Remove the wire connection of the limit switch which is connected to the 9#, 10#, and 11# terminals of the control board and then try it again. Replace the limit switch if the motor could run in both directions.</p> <p>3. Check the control board. Replace the control board as necessary.</p>
<p>The gate can open, but fails to close.</p>	<p>1. Photocell is obstructed. Remove obstruction.</p> <p>2. Check the limit switch. Remove the wire connection of the limit switch which is connected to the 9#, 10#, and 11# terminals of the control board and then try it again. Replace the limit switch if the motor could run in both directions.</p> <p>3. Check the control board. Replace the control board if necessary.</p>
<p>The motor runs but the gate doesn't move.</p>	<p>Ensure the clutch for emergency release is adjusted properly and is not slipping.</p>

## Maintenance

Every six months check the following items for proper operation of the unit.

- \* Lubricate shafts and sprockets.
- \* Keep opener clean at all times.
- \* Check and tighten anchors bolts.
- \* Check for loose or corroded wire
- \* Ensure the opener is well earthed, and correctly terminated.

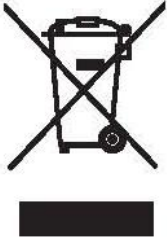

According to Waste of Electrical and Electronic Equipment (WEEE) directive, WEEE should be separately collected and treated. If at any time in future you need to dispose of this product please do NOT dispose of this product with household waste. Please send this product to WEEE collecting points where available.

## Feedback & Review

Your comments and suggestions are important to us  
as they help us provide the best possible service.

Should you have any need to contact us, the info below will help you get in touch:



TOPENS Website

**[www.topens.com](http://www.topens.com)**

Contact Us:

E-mail: [support@topens.com](mailto:support@topens.com)

*Kindly include your Product Model, Purchasing Date & Site, Order #,  
and your contact information. All your concerns will be replied within 24 hours.*

Tel: +1 (888) 750 9899 (Toll Free USA & Canada)