

Garage Door Operator

TM 50

TM 80

**INSTALLATION AND
PROGRAMMING INSTRUCTIONS**



TM50/80 MO911/1V0 SKRW433 SKR433-1

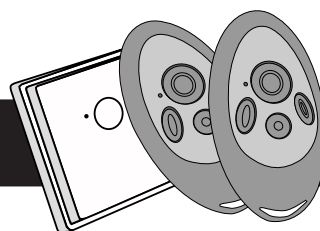

ENGLISH

Content

Quick Reference for experienced Installers	3	Remote Control	
Information and Remarks		Registering and deleting Remote Devices	16
Regulations and Usage	4	<i>Starting the Registry</i>	
<i>Directives and Regulations</i>		<i>Registering a Device</i>	
<i>Use of the operators</i>		<i>HomeLink™</i>	
<i>Garage Doors</i>		<i>Erasing Remote Devices</i>	
<i>The installers declaration of conformity</i>		General Remarks	17
<i>Older Garage Doors</i>		<i>Useable Batteries</i>	
<i>Instruction for the users</i>		<i>Changing the transmitters' battery</i>	
Safety Advises for the Installation	5	<i>Changing the wall push-buttons' battery</i>	
		<i>Synchronisation of the Rolling Code</i>	
Installation		Technical Information	
Conditions for Installation	6	Technical Data	18
<i>Minimum Headroom</i>		Wiring Diagram	18
<i>Door Hight</i>		<i>Internal Wiring</i>	
<i>Door Arm Extension</i>		<i>External connections</i>	
<i>Dimensions</i>		<i>Devices for adjustments</i>	
Pre-Mounting	6	<i>Others</i>	
Installation	7	Troubleshooting	19
		<i>Error Messages</i>	
Installation		<i>Messages by blinking integrated lighting</i>	
Adjusting the Limit Blocks	8	<i>Additional messages from the LED „Diag“ only</i>	
The Emergency Release	9	<i>If... then...</i>	
<i>When the garage door is the only entrance</i>		Declarations	
<i>When there is a second entrance to the garage</i>		EC-Declaration of Conformity	20
Printed Circuit Board: Adjustments and Connectors			
Control Elements	10		
Connectors	11		
<i>Push Button</i>			
<i>Photo Cell / Hatch Door Contact</i>			
Printed Circuit Board: Adjustments and Connectors			
Standard Programming	12		
<i>Programming Forces and Running Distance</i>			
<i>Choosing the type of door</i>			
<i>Programming Remote Components</i>			
Free Programming	13		
<i>Setting the speeds</i>			
<i>Setting the opening speed</i>			
<i>Changing the length of Soft Stop</i>			
Automatic Closing	14		
<i>Setting the time</i>			
<i>Pre-Warning by internal lighting</i>			
<i>Connecting a Photo-Cell</i>			
<i>Performance of Control Devices</i>			
<i>Avoiding automatic closing temporarily</i>			
<i>Further Safety Advice for Automatic Closing</i>			
Adjusting the Lighting Duration	15		

Quick Reference for experienced Installers



Adjusting the Door Type			
<p>Sectional door</p>	<p>Tilting Door</p>	<p>Canopy Type Doors</p>	<p>Free Programming</p>

After changing the DIP-switch settings the operator MUST run through a learning cycle: keep the LEARN button pressed for 3 seconds, release it and press it again shortly. For free programming, pls. refer to page 13.

Increased Force shortly before reaching Closed Position		
<p>Standard</p>	<p>Increased Force</p>	<p>Changing the DIP-switch settings must be confirmed by shortly pressing the LEARN button.</p>

Pre-Warning Light (always active when using automatic closing, pls. refer to page 14)		
<p>Off</p>	<p>ON</p>	<p>Changing the DIP-switch settings must be confirmed by shortly pressing the LEARN button.</p>

Automatic Closing			
<p>None</p>	<p>after 30 sec.</p>	<p>after 90 sec.</p>	<p>after 120 sec.</p>

Changing the DIP-switch settings must be confirmed by shortly pressing the LEARN button.

Connectors		
Push Button (potential free)	A + B	
Photo Cell and Hatch Door, 8.2 kOhm, Remove resistor and connect it to the photo cell by putting it in line with one impulse wire	C + D	
24V AC Output, max. 200mAmp.	24 V	

Programming	
Running Length and Forces	Keep the LEARN button pressed for 3 seconds, release it (the operators' light is now blinking) and press it again shortly
Remote Components (Transmitters, Digi Pad, Remote Wall Push Button)	Keep the LEARN button pressed for 3 seconds, release it (the operators' light is now blinking) and press the desired hand transmitter button
Changing the Duration of the Internal Lighting	Keep the LEARN button pressed for 6 seconds, release it once the green LED starts glowing. Press LEARN button once again shortly -> the green LED starts blinking. Each blink stands for 10 seconds of light duration. Once the desired duration is reached, press the LEARN button again shortly (e.g. after 6 blinks for a duration of 60 seconds).

LED-Indicators	
Vp (yellow)	On when 230V supply is o.k.
TEST/FUNK (green)	On whilst an impuls is received from remote devices or a connected push-button (A+B)
8k2/Diag (red)	On when an error from a connected safety device is received (connectors C+D) or blinks in intervalls to indicate error messages (refer to page 19)

Regulations and Usage

It is within legal regulation and without restriction, to use a Seip door operator with any garage door that has been approved for use with other certified door operators!

Directives and Regulations

The TM garage door operator comply to the latest European directives and regulations. The declaration of conformity is enclosed at the end of these instructions.

Use of the operators

The operators were designed for the use with up-and-over doors (tilting and canopy-type) and sectional doors.

All garage doors need to be maintained before automation. The door must be easily opened and closed by hand. A garage door must not be automated unless it is easy to open and close manually.

Garage Doors

In January 2001 the European regulations EN12604 and EN12605 became compulsory for garage doors. Before installing an automatic door operator it must be assured that the garage doors applies to these regulations (the information can be obtained from the manufacturers' declaration of conformity). A Seip door operator may be installed to any door that complies to the regulations. Should a garage door not be compliant then please refer to the chapter „older garage doors“.

The installers declaration of conformity

No matter whether a door operator was delivered together with a garage door or seperately, the installer must issue a declaration of conformity for the complete installation.

With this declaration the installer assures, that the installation was made according to the instructions given by the manufacturers (e.g. the installation instructions of the garage door and the operator). This declaration can only be issued by the installer and may not be issued from the manufacturer!

If both components comply to the directives and the installation was made as to the manufacturers instructions the whole installation will normally be CE-compliant.

Older Garage Doors

When automating an older garage-door the TS-series will still comply to the regulations - through the automatic force setting the requested values for forces and reversion will be according to the regulations.

But it needs to be taken in consideration that most older garage doors do not meet the regulations EN 12604 and EN 12605 - especially regarding security features. They might still have sharp edges bearing the danger of severe injuries - for example sectional doors might not have a finger protection between the sections. Unfortunately the entire regulations do not mention how to handle the automation of such an older garage door - the danger basically is not the automation but the construction of the door.

Therefore we strongly recommend to

- check the garage door for sharp edges bearing danger when the door is moving; take any necessary action to avoid the dangers and make the door safer
- check the doors' springs and readjust them if necessary
- grease or oil the pivotal points and rollers of the garage door
- check that the door may be easily used by hand

If, however, the dangers cannot be avoided we recommend to use the automatic pre-warning function of the operator. The operators' lighting will then be blinking for approx. 5 sec. before every movement of the garage door. People inside the garage will be warned before the opening and can step back from the garage door in time.

Instruction for the users

Please instruct the users as follows:

- Use of the hand transmitter
- Use of the emergency release in case of a power failure
- Hand over the separate „User Manual“ to the customer
- Inform the user about the Security Advises in the User Manual

Safety Advises for the Installation

Important Safety Instructions for Installation

WARNING: INCORRECT INSTALLATION CAN LEAD TO SEVERE INJURY

Follow all Installation Instructions.



- Read page 3 of this instruction carefully before the installation

- Before installing the drive, remove unnecessary ropes from the existing installation

- Maintain the garage door according to the advises on page 3 and to the door manufacturer's manual

- If possible, install the drive at a height of at least 2,10 m and the manual release at a height less than 1,80 m

- Locate the push-button within sight of the door but away from moving parts and at a minimum height of 1,50 m

- Fix the label warning against entrapment next to the push-button

- The label fixed to the manual release may not be removed

- After installation, ensure that the mechanism is properly adjusted and that the drive reverses when the door contacts a 40 mm high object placed on the floor.

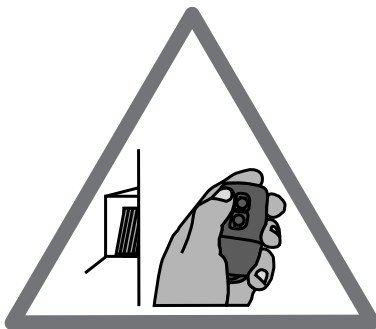

Conditions for Installation

Minimum Headroom

A minimum distance of 35mm between the garage door and the ceiling is required.

Door Height

No optionals are required for doors up to 2,250mm high.

Between 2,250mm und 2,500mm: a lintel-sided extension for the rail might be required. The operator will be set back by approx. 300mm in order to use the full running length up to the front pulley (2,500mm max.)

Higher than 2,500mm: The C-rail must be extended. Extensions are available at 500mm and 1,000mm; the operator can be extended by 1,500mm in total. The maximum door height is 4,000mm

Door Arm Extension

Should the minimum space between the garage door and the ceiling be smaller than 35mm then a door arm extension is needed. For an extension you can use a metal beam from any DIY-market. The beam should not be shorter than the door's height.

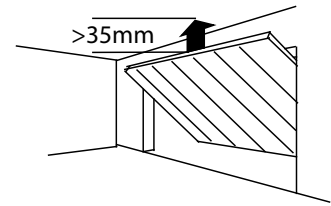

Dimensions

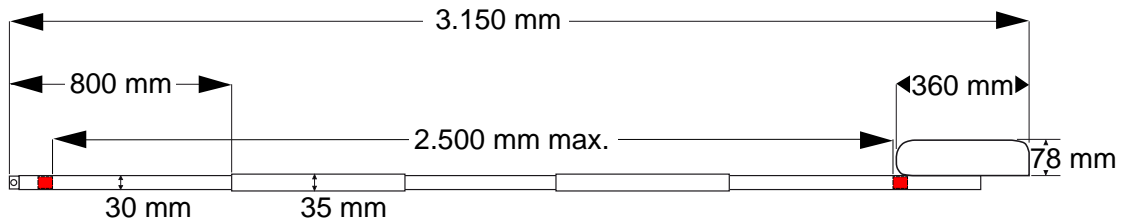

Pre-Mounting

Be aware not to twist the chain - rather slide the rail parts on the floor than lift them.

The overall rail consists of three parts at 1m and two junction parts which will keep the rails together.

1. The empty piece of rail must be joined to the rail which is fixed to the motor head. Run the junction-part over the joint till stop.
2. The junction-part in front shall prolude for approx. 1cm
3. Slide the last piece of rail, which carries the pulley in front, from above into the proluding junction-part and press it down (the chain will be tensioned). Slide the junction-part over rail till stop.
4. Turn around the operator and tighten the grub-screws in the junction-parts in order to keep them in place.

The operator is now fully pre-mounted for installation.

The chain is factory pre-tensioned. **Do not change the chain tension.**

ATTENTION: Before using the operator the limit-blocks must be set up and the operator must be put in programming mode. Otherwise the operator will produce an error message!

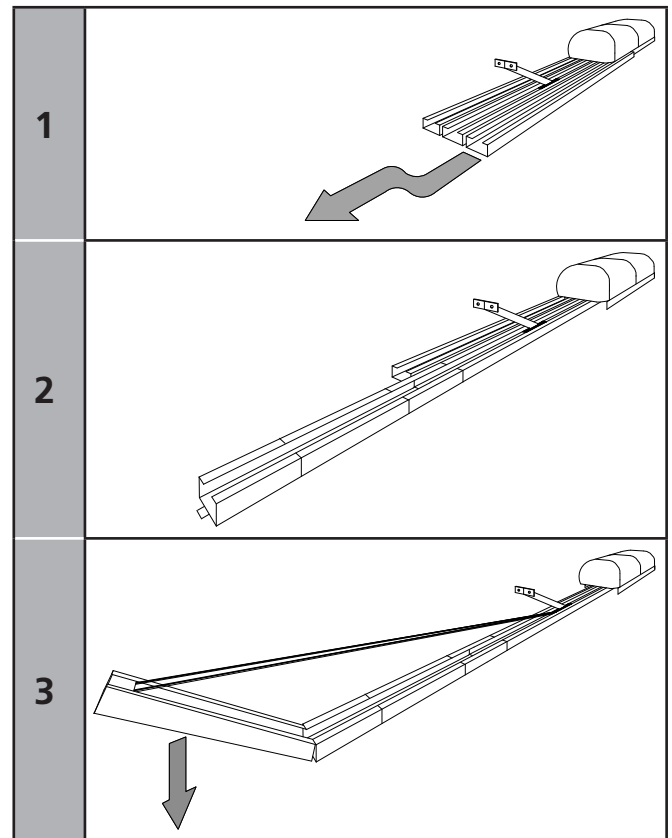

Installation

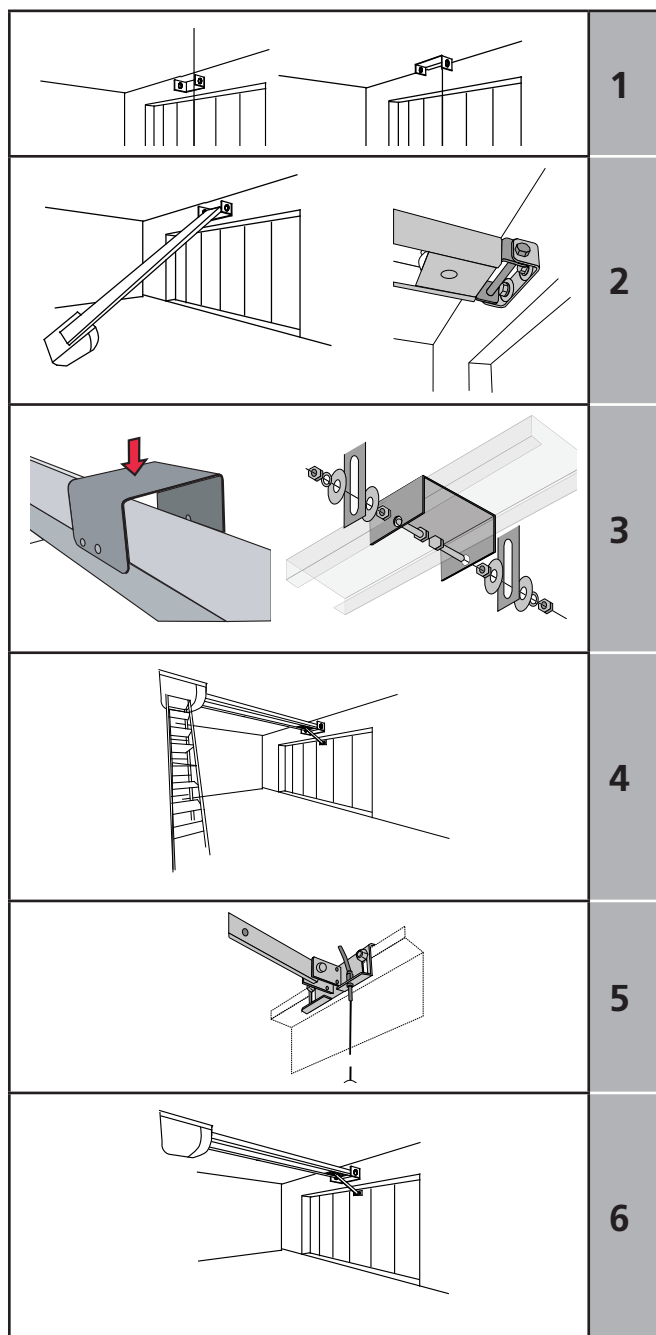

The front fixing angle can be mounted either at the lintel or at the ceiling.

1. Measure the middle of your garage door and make a mark on the lintel and the top of your door (1).

2. Fix the front fixing angle in the middle either at the lintel or at the ceiling (lintel recommended) (2).

3. Attach the C-rail to the front fixing angle (2). Put a carton piece under the motor head unit to avoid damages.

4. To fit the motor head to the ceiling it is recommend to use a ladder (4). When the operator is laying on the ladder you can open the garage-door. Adjust the C-rail according to the mark you made in the middle of the garage-door.

Fit the operator to the ceiling when you have made sure the C-rail is running straight to the front. Use the supplied bracket to fix the C-rail to the ceiling (3).

5. Now fit the door arm to the garage door (5). Take care that the angle between the operator and the door arm does not exceed a max. of 45° (it may be lower).

6. The limit-blocks must be tightened and the programming must be started before running the operator (page 8)! The garage doors' locks must be removed before running the operators - otherwise damages on the garage door or operator might occur!

For additional security our locking set can be obtained as an optional extra.

Adjusting the Limit Blocks

These adjustments **must** be made **before the programming of the forces and the running-length.**

Starting the programming procedure without correctly adjusted blocks may lead to damages on the garage door and the operator!

Vorgehensweise:

1. The operator is mounted and the door-arm is fixed to the garage-door. The trolley is locked to the chain and stands somewhere between the two blocks. If, however, trolley and chain need to be moved you may do this using the TEST/RUN button.

2. Release the trolley (Pic. 1) and manually close the garage door.

3. The block for the closing direction is now right in front of the trolley (Pic. 2). If not, the block must be moved until it touches the trolley.

4. Tighten the blocks' screw to keep it in place. Take care not to tighten it too strongly - the c-rail should not be bended.

5. Now the garage door needs to be opened manually. The trolley will lock into the chain - you have to release it once again to fully open the garage door. (Pic. 1).

6. The block for the opening direction is now right in front of the trolley (Pic. 3). If not, the block must be moved until it touches the trolley.

7. Tighten the blocks' screw to keep it in place. Take care not to tighten it too strongly - the c-rail should not be bended.

8. The trolley now needs to be locked back to the chain!

After that the programming procedure may be started (page 12 onwards).

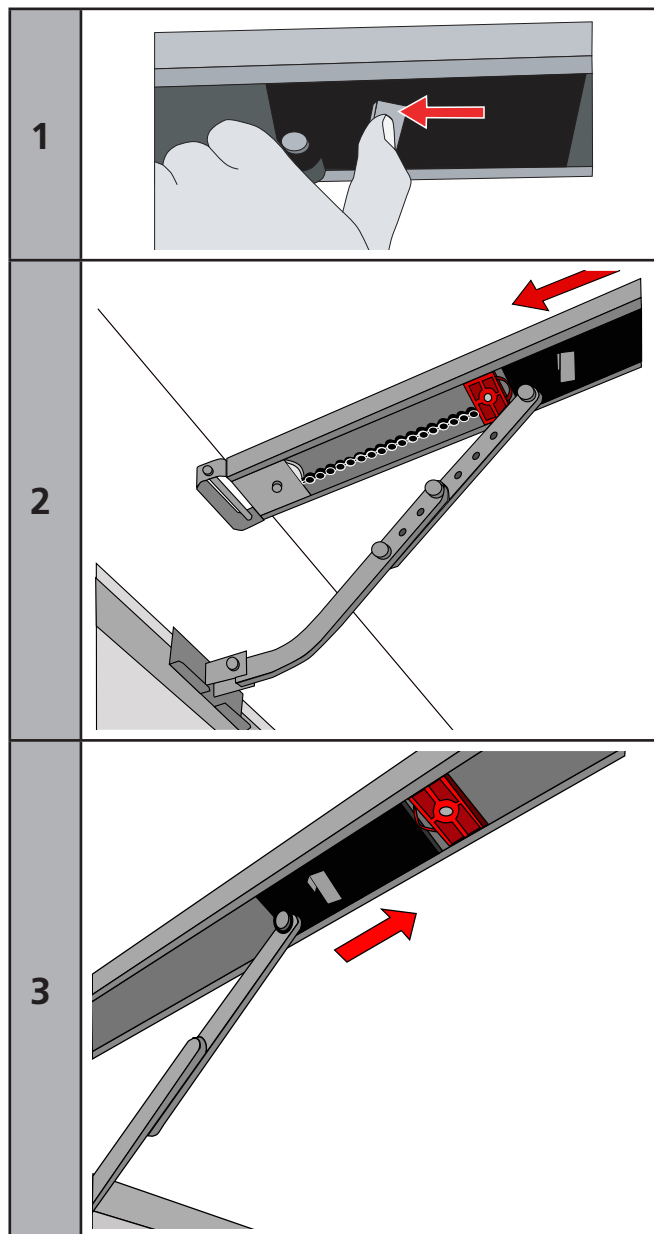

The Emergency Release

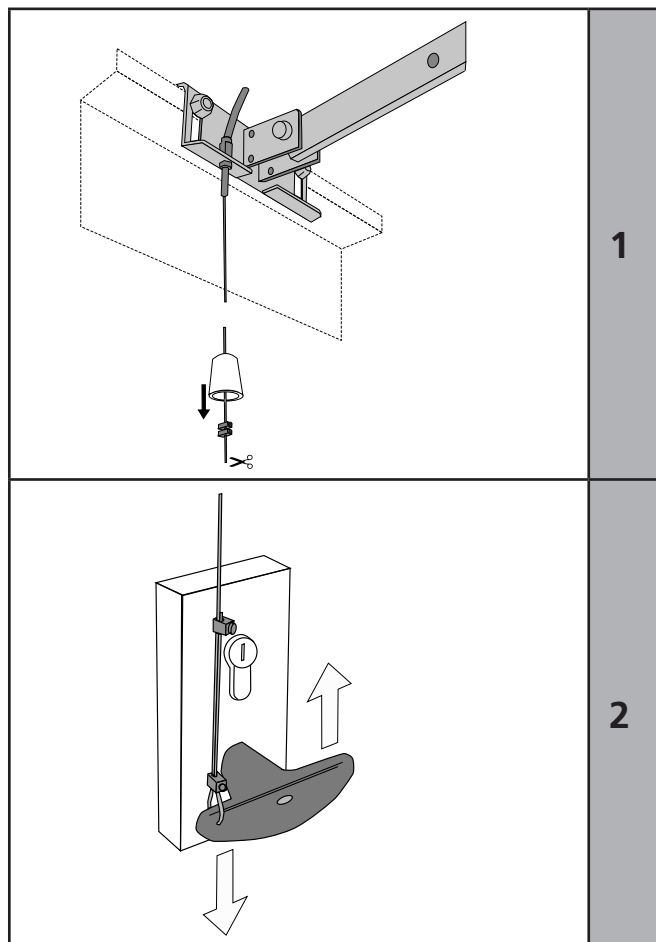

1

In case of a power failure the garage door can be opened by hand. Therefore the operator first needs to be released.

When the garage door is the only entrance

It is necessary to connect the emergency release to the door's handle (pic. 1) otherwise the garage cannot be accessed in a power failure situation.

Proceed as follows:

1. Find out in which direction the door handle moves when opening the door.
2. Drill a hole in that side of the door handle which turns downwards.
3. Thread the cable through the hole and fix it with the enclosed metal-clamps. Be careful not to put a high tension on the emergency release cable - the operator then might release from the garage-door during a normal opening cycle.
4. Check the function of the emergency release together with a second person. Stay inside the garage and close the door with the operator. Let the second person open the door manually with the door keys. If this works, the emergency-release is mounted properly.

Do not leave the garage and close the garage-door with the operator before you have tested the emergency-release!

2

When there is a second entrance to the garage

You can use the supplied handle for the emergency release (pic. 2).

Thread the emergency release cable through the handle. Fix the metal clamps to the cable where the handle shall be placed.

Shorten the cable below the metal clamps - the handle is now being held by the clamps.

In case of a power failure the user can now open the garage door by releasing the operator with the handle for the emergency release.

Control Elements

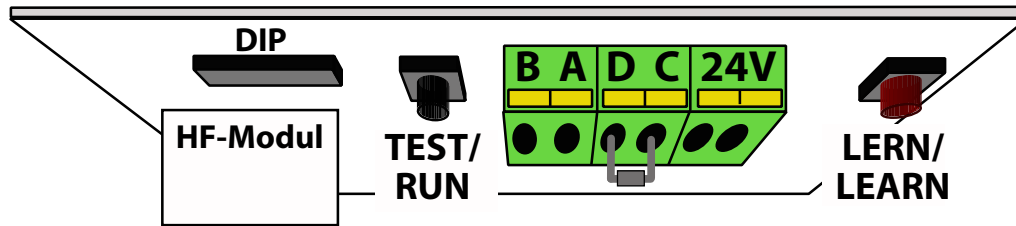

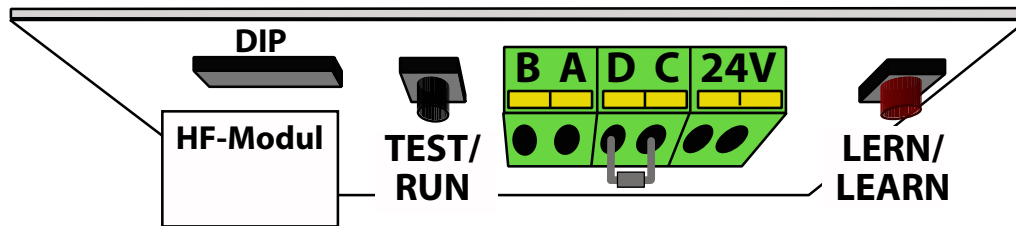

TEST/RUN Button (black)	
Standard Function	<u>Run the operator:</u> Pressing the button runs or stops the operator. The function depends on the entire status of the operator, following the sequence OPEN-STOP-CLOSE etc.
Function when Automatic Closing is active	<u>Opening command:</u> Pressing the button gives an opening command. When the garage door is open then pressing the button will extend the opening time. When pressing the button during the closing procedure, then the operator will stop and open the door again.
Programming Functions	<p><u>Adjusting the limit blocks:</u> In programming mode the operator can be run by keeping the TEST-button pressed. When the button is released, then the operator will stop - when pressing the button again then the operator will run into the opposite direction.</p> <p><u>Reducing the running speeds:</u> When setting the opening and closing speed in „free programming“ mode then each press of the TEST-button will reduce the running speed by one level.</p>
LERN/LEARN Button (red)	
Standard Function	<p><u>Starting the programming mode:</u> The button must be kept pressed for approx. 3 seconds and then must be released; the operators' light starts blinking and the operator is in programming mode. Using the TEST-button the operator can be run to adjust the limit switches.</p> <p><u>Starting the learning cycles:</u> Once the operator is in programming mode, a short press on the LEARN-button will start the learning cycles for the running length and the force-measurements.</p>
DIP-Switch Confirmation	<p><u>Changing the settings of DIP-switches 3 to 6:</u> Once the DIP-switch setting is changed, it must be confirmed by shortly pressing the LEARN-button.</p> <p><u>Changing the settings of DIP-switches 1 and 2:</u> Keep the LERN-button pressed for approx. 3 seconds until the integrated lighting starts blinking. Release the LERN-button and press it once again shortly to start the learning cycles. When set to „free programming“, then pls. refer to page 13.</p>
Programming Functions	<p><u>Adjusting the time for the integrated lighting:</u> The LERN-button must be pressed for approx. 6 seconds until the green LED starts blinking; then release the button. Pressing the button again, will confirm the the new time for the integrated lighting.</p> <p><u>Increasing the running speeds:</u> When setting the opening and closing speed in „free programming“ mode then each press of the TEST-button will increase the running speed by one level.</p>
Combined Functions of TEST and LERN Button	
Change speed settings when DIP-switches were set to „free programming“	The LERN-button must be kept pressed. In addition the TEST-button must be kept pressed. After approx. 3 seconds the operators lighting starts blinking and the red LED starts blinking in a sequence. Both buttons must now be released. The operator is now in the mode to adjust the closing and opening speed, pls. refer to page 13.
DIP-Switches	
1+2 Standard: 1 OFF, 2 ON	<u>Adjusting the type of garage door:</u> It may be chosen either sectional door (standard adjustment), tilting door, short running door (e.g. Canopy type doors) and free programming.
3 Standard: OFF	<u>Additional force shortly before closed position:</u> When using mechanical locking systems a higher force might be necessary in order to ensure a proper locking. Setting the switch to ON increases the force before reaching the closed position.
4 Standard: OFF	<p><u>Pre-warning:</u> When set to ON, the operators' lighting will blink for approx. 4 seconds before every opening or closing.</p> <p><u>When automatic closing is activated:</u> When set to OFF, the operators' lighting will blink for 6 seconds before closing the door. When set to ON, it will be blinking before openings and closings.</p>
5+6 Standard: OFF	<u>Automatic closing:</u> The time until the door will be closed can be set to 30, 90 or 120 seconds. For programming pls. refer to page 14.



Push Button	
A + B	Connector for a wired wall push button
Standard function	Pressing the push button will give a command to the operator. Whether this is an opening, closing or stop command depends on the entire status of the operator.
Function when using the automatic closing feature	<p>Pressing the push button:</p> <ul style="list-style-type: none"> will give an opening command when the door is closed will be ineffective when the operator is running into opening direction will extend the time the door is kept open when the door is in open position already will give an opening command when the operator is running into closing direction <p>To avoid the automatic closing occasionally, a standard wall switch may be connected. Whilst it is switched on, the push button connector will be blocked and the operator cannot close the door unless the wall switch is set to off position. It may be connected parallel together with a wall push button.</p>
Photo Cell / Hatch Door Contact	
C + D	<p>Connector for the impulse wires of a photo cell or a hatch door contact. The 8.2kOhm resistor is used to survey the wire. It must be removed from C+D and must be connected to the safety device as shown below.</p> <p>If both, a photo cell and a hatch door contact, must be used, then both items must be connected in one line.</p> <p>Photo Cell:</p> <p>Hatch Door Contact:</p>
Standard function	<p><u>Openings:</u> If the device detects an obstacle within approx. 2 seconds after running from closed position, then the operator will stop (e.g. hatch door is open). After these 2 seconds the connector is not being checked anymore for the rest of the opening run.</p> <p><u>Closings:</u> The connector will be checked during the whole closing procedure. Once an obstacle is detected, the operator will reverse to fully open.</p>
Function when using the automatic closing feature	<p><u>Openings:</u> pls. refer above to „Standard function“</p> <p><u>Closings:</u> The connector will be checked during the whole closing procedure. Once an obstacle is detected, the operator will reverse to fully open. The adjusted time for automatic closing will start running. If the obstacle will be removed after the automatic closing time has elapsed, then the closing procedure will start immediately.</p>
24V AC Output (200mA max.)	
24V	24V a/c (max. 200mA) power supply for external components (for example photo cells or remote receivers)

Standard Programming

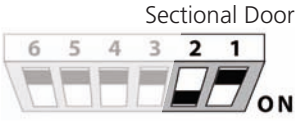
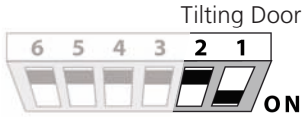
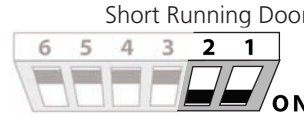
Programming the Forces and Running Distance

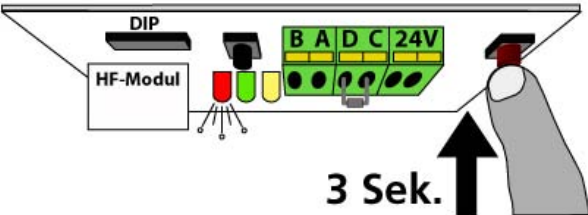
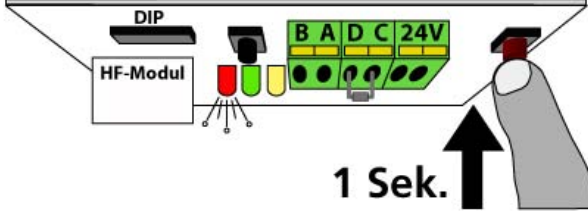
1	<p>Choosing the type of door The standard pre-setting is „Sectional Door“; if this shall be used, then proceede with step 2. For other types of doors the DIP-switches 1 and 2 must be adjusted accordingly.</p>	<p>Sectional Door</p> 	<p>Tilting Door</p> 	<p>Short Running Door</p> 	<p>Free Programming</p> 
	<p>When the DIP-switch settings are changed, the red LED starts blinking in intervals; proceede as described below.</p>	<p>Pls. refer to chapter „Free Programming“, Page 13.</p>			
2	<p>Keep the red LEARN-button pressed for approx. 3 seconds. Release the button once the red LED and the operators' lighting start blinking.</p> 				
3	<p>Press the LEARN-button once again shortly.</p> 				
4	<p>The operator now starts with the learning cycles (force measurement and running distance):</p> <ul style="list-style-type: none"> - it hits the OPENING limit block - it closes slowly until it reaches CLOSED-position - it opens fast until it reaches OPEN-position - it closes fast until it reaches CLOSED-position <p>The operators' light keeps blinking for a little while after the operator stops running. Once the operators' light stops blinking the programming has been successful.</p>				

Programming Remote Components

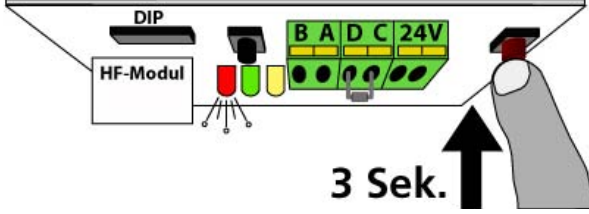
1	<p>Keep the red LEARN-button pressed for approx. 3 seconds. Release the button once the red LED and the operators' lighting start blinking.</p> 				
2	<p>Press the button on the remote component which is intended for use with the operator for approx. 1 second. The operators' light stops blinking and the component was programmed successfully. Steps 1 and 2 must be repeated for each remote component. For more information on remote components pls. refer to page 16.</p>				

Free Programming

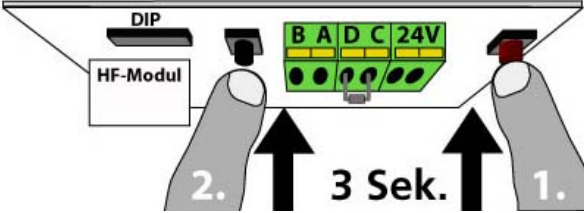
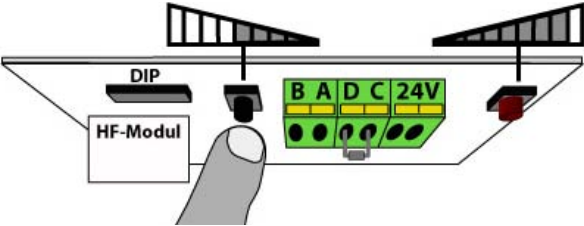
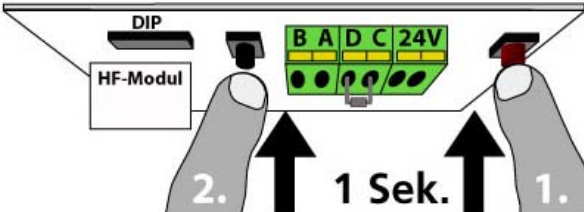
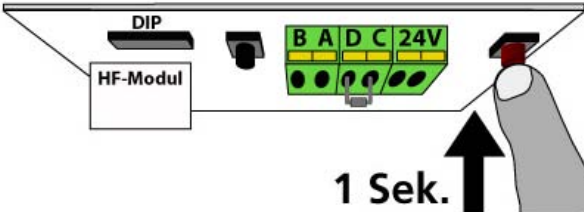

ATTENTION: Changing the running-speeds might result in non-conformant force values dependant on the door type and the doors' weight. To ensure the installation is within legal regulations a force testing as to directive EN13241-1 must be made.

1	<p>Free Programming</p> 	<p>Opening and closing speeds can be set manually when running the free programming mode. The length of the soft-stop in closing direction may also be set manually. When running the free programming for the first time all speeds are set to maximum. After changing the DIP-switch settings the red LED will start blinking in intervals (2 blinks - break - 2 blinks) - proceede with step 2.</p>
2	<p>Setting the speeds Press the LEARN-button followed by the TEST-button and keep both pressed for approx. 3 seconds. Release the buttons once the red LED starts blinking.</p> <p>The red LED will blink for up to 8 times followed by a break. The mode for programming the speeds is active.</p>	
3	<p>Setting the closing speed The number of blinks of the red LED indicates the entire speed setting: 8 blinks = maximum speed 1x blink = minimum speed</p> <p>By means of the black TEST-button the speed can be reduced; each press reduces the speed by one step. Wait for the break after the blinks and then start counting to evaluate the entire speed setting. By means of the red LEARN-button the speed can be increased.</p>	
4	<p>Confirm the selected speed Press the LEARN-button followed by the TEST-button; keep both pressed for approx. 1 second and release them. You are automatically in the mode for setting the opening speed. The program is now in the mode to set the opening speed.</p>	
5	<p>Setting the opening speed After completing step 4 the red LED is blinking up to 8 times followed by break. Setting the opening speed is made the same way as described in step 3 and 4. After confirming the selected opening speed the LED and the operators' lighting will be blinking regularly, the speeds have been set successfully.</p>	
6	<p>Starting the learning cycles Shortly press the LEARN-button. The operator will first run in opening direction and hit the upper limit block. If you wish to keep the standard soft-stop in closing direction, no further action is required. Wait until the operator has completed the learning cycles (the door will then remain in closed position and the operators' lighting will stop blinking). The programming then is completed.</p>	
7	<p>Changing the length of Soft Stop Once the learning cycles have started and the upper limit block was hit, the operator will run in closing direction. During this first run in closing direction the soft stop may be altered: press the red LEARN-button and keep it pressed. The operator will increase speed. Release the LEARN-button where you want the soft stop to start in later operation. The speed will be reduced and the new soft stop setting will be safed. Wait until the operator has completed the learning cycles, then the programming is completed.</p>	

Automatic Closing



WHEN USING THE AUTOMATIC CLOSING FEATURE A PHOTO-CELL MUST BE CONNECTED. A PHOTO-CELL IS A NON-CONTACT SAFETY DEVICE AND WILL AVOID IN MOST CASES THAT USERS, CARS OR OTHER OBSTACLES WILL BE HIT BY THE CLOSING GARAGE DOOR!

The closing procedure will be started automatically after the pre-set time; the door might be unattended at that time. Without a photo-cell the operator will only reverse when hitting an obstacle. Especially moving cars may cause severe damages on both, car and garage door!

1 Setting the time

Automatic closing is disabled by factory presetting. Setting the time after which the automatic closing shall start enables the feature. DIP-switches 5+6 must be used for the time setting:

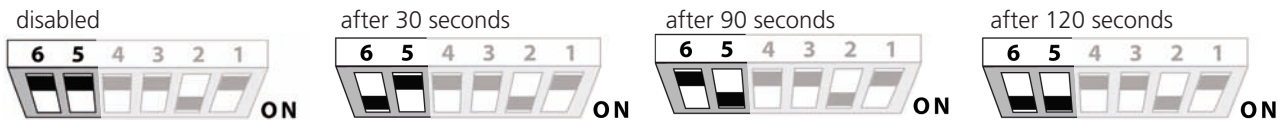

After changing the DIP-switch settings the red LED will start blinking in intervals. Shortly press the red LEARN-button to confirm the new settings; the LED stops blinking and the automatic closing is now active.

2 Pre-Warning by internal lighting

When automatic closing is active the operator will always pre-warn the users by a blinking internal lighting. The operator will start closing the door after 6 seconds of pre-warning. By means of DIP-switch no. 4 the pre-warning can additionally be enabled before openings:



External warning lights may connected together with the integrated operators lighting using the connectors 5+6 (230V, 160 Watts max.). The operators housing must be removed in order to access the connectors. **Cabling and connections of 230V components may only be done by authorised professionals.**

3 Connecting a Photo-Cell

As a non-contact safety device a photo-cell must be connect when using the automatic closing feature.

When the door is open and an obstacle is detected by the photo-cell then the operator will not start the automatic closing procedure.

When an obstacle is detected during the closing procedure then the operator will reverse to fully open and it will restart the count-down for automatic closing. It will then start the closing procedure again.

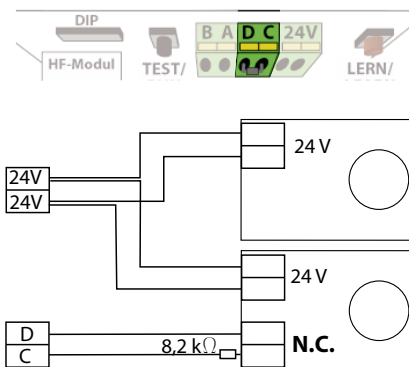

4 Performance of Control Devices

When the automatic closing is active all incoming commands during the opening cycle will be ignored - the operator will keep running until to fully open position.

Interrupting the opening procedure will only be possible by:

- Force detection (e.g. obstacle)
- Detection by Photo-Cell/Hatch Door connector for approx. 2 seconds after starting the opening procedure

When the door is in fully open position incoming commands will restart the count-down for the automatic closing, e.g. the time will be extended.

5 Avoiding automatic closing temporarily

If the user would occasionally like to prevent the door from automatically closing, then an ordinary wall switch can be connected to the push-button connectors A+B. The operator will remain blocked as long as the wall switch is switched on; when switching it off the operator will close the door automatically again. A wall switch may be connected alongside a wall push-button.

Automatic Closing



Further Safety Advice for Automatic Closing

Once the user gets into the car, he might not recognize the operators' integrated blinking light before the automatic closing starts. This may be down to light conditions or the cars' roof. Therefore it is strongly recommended to install an external warning-light which is visible from inside the car.

This is similar for users approaching the garage; dependant on light conditions the blinking integrated lighting might not be recognized in time. Therefore a further warning-light should be installed outside the garage in order to maximize the safety in use.

Adjusting the Lighting Duration



The integrated lighting will be switched on with every incoming command. The adjusted time will run from the moment the command was received.

Factory pre-set the light will stay on for 3 minutes. This time may be changed in steps of 10 seconds up to a total of 10 minutes.

To change the time proceede as follows:

1	<p>Keep the red LEARN-button pressed for 6 seconds. Release the button once the green LED comes on.</p>	<p style="text-align: right;">6 Sek.</p>
2	<p>Press the red LEARN-button once again shortly. The green LED now starts blinking: each blink stands for 10 seconds of lighting duration.</p> <p>6 blinks = 1 minute 12 blinks = 2 minutes 18 blinks = 3 minutes 24 blinks = 4 minutes 30 blinks = 5 minutes 100 blinks = 10 minutes</p>	<p style="text-align: right;">1 Sek.</p>
3	<p>Press the red LEARN-button shortly once the require time is reached. The green LED stops blinking and the new duration for the integrated lighting has been stored.</p>	

Registering and deleting Remote Devices



In order to use a remote device it must first be registered with the operator. A total of 10 remote devices may be registered with one operator, the registration must be made separately for each device. If the total of 10 devices is exceeded, the last registered device will be overwritten by the new one. It is not possible to register more than one button of the same hand transmitter with the operator.

1 Starting the Registry

Keep the red LEARN-button pressed for 3 seconds. Release it once the red LED and the operators' lighting start blinking.

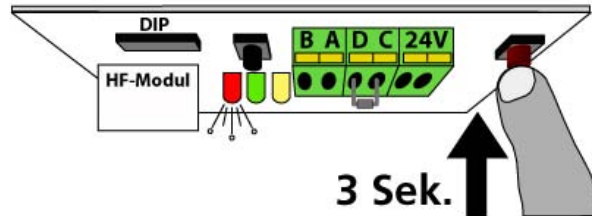

The operator now is in programming mode and awaits the signal from a remote device.

2 Registering a Device

Press the button that shall be used for controlling the operator for approx. 1 sec.

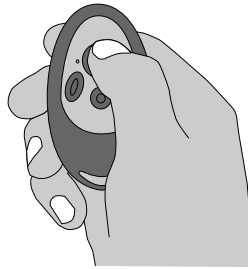

The red LED and the operators' lighting stop blinking - the device was programmed successfully. Pressing the devices' button again will run the operator. Repeat steps 1 and 2 for any further device.

HomeLink™

Integrated car remotes usually use the HomeLink™ system by Johnson Controls. Systems from version 6 or higher are compatible with the operator.

First the hand transmitter must be copied into the HomeLink™ module (closer information on your specific system can be found on the internet: www.eurohomelink.com).

The programmed HomeLink™ button will turn to a new Seip-compatible remote device. It therefore must be registered with the operator just like any other remote device. Proceede as described in steps 1 + 2.

Erasing Remote Devices

The receivers' memory can be erased completely; it is not possible to delete single devices. To erase the receivers' memory keep the red LEARN-button pressed for 10 seconds:

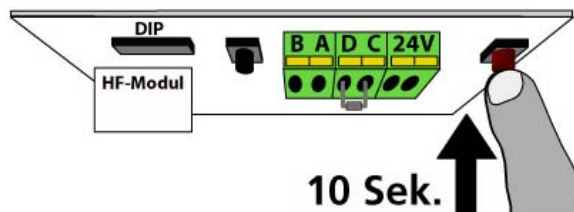

After 3 seconds the red LED and the operators' lighting will start to blink; after 10 seconds the red LED will come on permanently, release the LEARN-button then. The memory now is empty.

General Remarks



Useable Batteries

Eine Batterie des Typs A23, 23A, 23L, EL12, VR 22 oder MN 21; Versorgungsspannung: 12V
Verbrauchte Batterien müssen nach den nationalen Bestimmungen entsorgt werden!

Changing the transmitters' battery

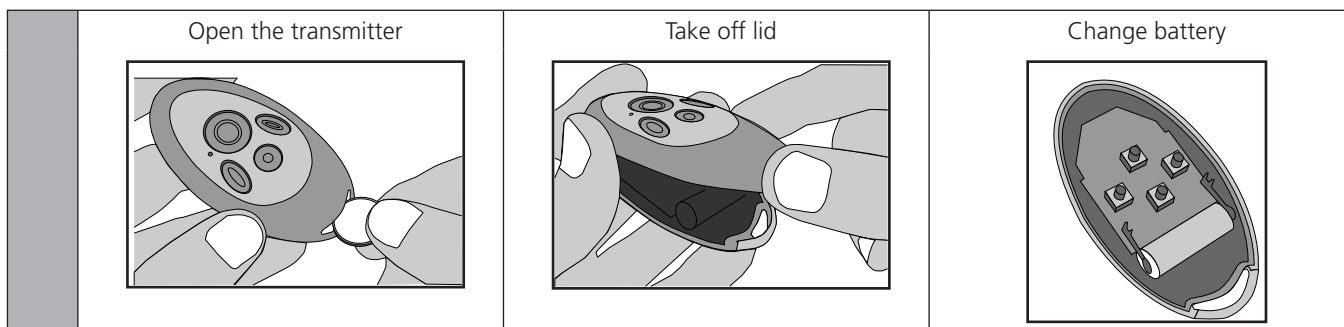

Changing the wall push-buttons' battery

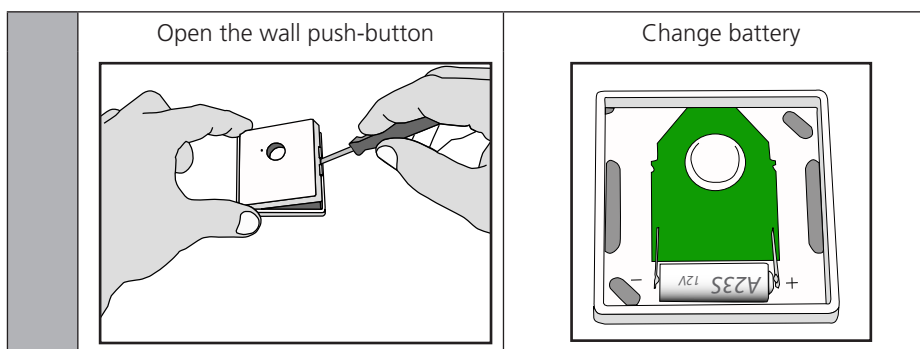

Range

The TM operator is equipped with a high quality remote control set as a standard! However, the remote control is the part of the operator which might be influenced by circumstances in the surroundings of the garage. With our standard remote control you might reach a range of more than 100 meters.

The range is influenced by:

- old batteries: if you should experience a problem with the range, please change the batteries first. The lower the batteries run the lower the range will be.
 - Building materials of the garage: In a garage made of concrete and steel you might reach a lower range than in an ordinary garage build of stone. The more steel was used for the walls the shorter the range of your remote-control.
- Remote-control activity in the area: Radio and television transmitters close to your garage might reduce the range.
Older baby-phones and other household remote equipment: Some equipment like remote head-phones and baby-phone might produce strong disturbant signals which could reduce the range of other remote devices.

It is extremely unlikely that the range will drop to an unacceptable distance. If, however, problems should occur we will like to be helpful.

Synchronisation of the Rolling Code

With each command given by a remote device a new code for the next command is created; this new code will be agreed with the receiver. If a device is subsequently used for approx. 30 times out of reach of the receiver, then it will not be accepted by anymore - the latest code is unknown to the receiver. The device must first be registered with the operator again in order to use it (refer to page 16).

Technical Data

	TM 50	TM 80
Nominal Pulling Force	50 kg	80 kg
Peak Pulling Force	60 kg	90 kg
Force-Setting for Operation	automatic	
Motor	24V DC, low-noise	
Max. Running Speed	18 cm/sec.	14 cm/sec.
Speed in Soft Mode	8 cm/sec.	8 cm/sec.
Time for 2,10m opening	11,5 sec.	16 sec.
Lighting	230V AC, max. 40W	
Lighting Durance (adjustable)	10 sec. to 10 minutes	
Duty Cycle	50%	
Stand By Power Consumption	2.0 watts	
Power Supply	190-250V AC	
Transformer	230V AC, 24V AC	
Pre-Warning Light	adjustable	
Automatic closing	adjustable	

	TM 50	TM 80
Net Running Length	2,500 mm	
Max. Running Length extended	4,000 mm	
Overall Length	3,150 mm	
Height Motor Head	80 mm	
Length Motor Head	360 mm	
Width Motor Head	180 mm	
Minimum Space above the door	35 mm	
Weight including packaging	18 kg	
Noise Emissions	≤ 60 dB(A)	
Programmable Remotes	10 max.	
Max. number of cars/garage	1	3

Subject to technical alterations!

Maintenance: The operator is maintenance free! Do not grease or oil the chain!

Wiring Diagram

Internal Wiring	
1	Blue, mains supply, 230V
2	Brown, mains supply, 230V
3	Black, transformer, 230V
4	Black, transformer, 230V
5	Brown, Lighting, 230V
6	Blue, Lighting, 230V

External connections	
A + B	Floating connector for push-button, key-switch and the impulse cables of an external receiver
C + D	Floating connector with a 8,2kOhm resistor for impulse cables from a photo-cell receiver
24V	24V AC for a photo cell transmitter when a self test before every movement of the door is required

Devices for adjustments	
Button „Test/Run“	Runs the operator - OPEN-STOP-CLOSE
Button „Lern/Learn“	For automatic force setting and registration of hand transmitters
Jumper “FORCE/PRES-SURE”	Setting of lower or higher force

Others	
HF-Modul/Receiver Card	Plug for receiver module, 433 MHz
FUSE	Fuse T1,6A 250V

7	White, transformer, 24V
8	White, transformer, 24V
9 MOTOR	Connector for the plug from the motor
PE	Earthing from P.C.B. to base plate
Earthing of the mains supply	The earthing of the mains supply (green/yellow) is connected to the base plate with a screw (the screw is marked with a earthing symbol)

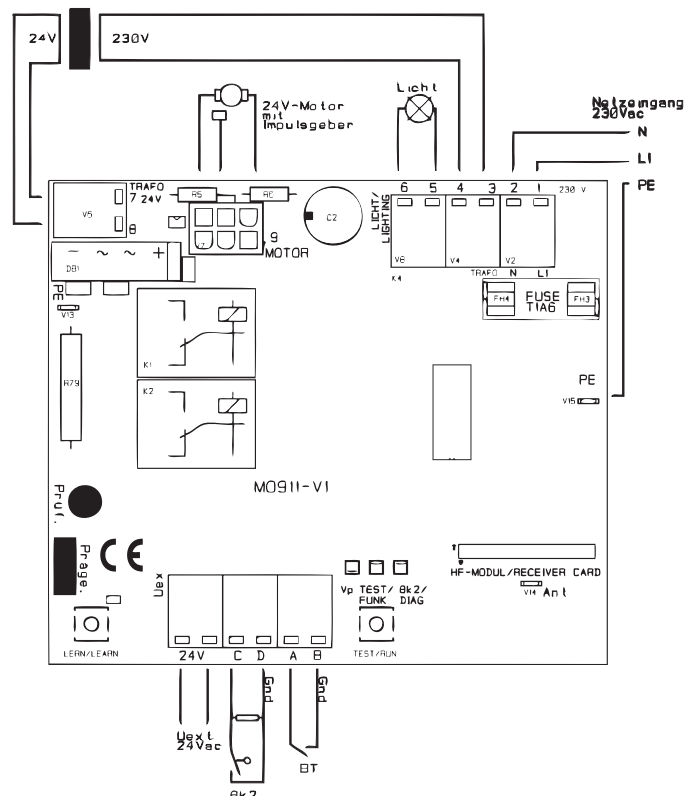

Error Messages

The operator will show error messages either by a blinking operators' lighting or the red LED.

Messages by blinking integrated lighting	
2 blinks	DIP-switch message: the DIP-switch setting was changed. Either press LEARN-button to confirm the change or start the learning cycles (page 12).
3 blinks	The end position could not be reached, the operator switched off at time limit. Possible reason: motor damage or other mechanical problem.
5 blinks	Loss off data in the micro processor - try to start the learning cycles (page 12). If this does not work the electronics must be exchanged.
6 blinks	EEPROM error: The electronics must be exchanged
7 blinks	Relais damage - the electronics must be exchanged.

8 blinks	No impulses from the motors' hall-sensor. Possible reasons: damaged hall-sensor, loose contact on the motor plug or damaged motor.
9 blinks	Amplifier for motor control is defective, the electronics must be exchanged.

Additional messages from the LED „Diag“ only	
4 blinks	An error occured when testing the photo-cell connector. Either the 8.2kOhm resistor is defective or the photo-cell/hatch-door produced an error.

If... then...

The operator does neither react on the transmitter nor on the push-button

Power failure? Disconnect and connect the operator. Is the door stuck because of snow and ice? Check the lines and the connections of the push-button switch. Is there water in the push-button switch or in the key operated switch? Disconnect alle external components and try running the operator via the TEST/RUN button.

The operator reacts on the transmitter but not on the push-button switch

Check the line of the push-button switch. Does the push-button switch work, when the remote receiver is disconnected? If so, the remote transmitter or receiver might be defective.

The operator reacts on the push-button but not on the transmitter

Check the battery of the transmitter. Try registering the transmitter with the operator (page 16).

The operator neither reacts on the push-button nor on the transmitter

Disconnect the receiver or remove the transmitter battery. Use your push-button switch only. If this solves the problem, your transmitter may be defective. Disconnect the push-button switch and use your transmitter only. If this solves the problem, the push-button switch or the line of the push-button switch may be defective.

The door doesn't close completely and opens again

Is the door jamming while closing? Unlock the carriage manually (make the door running well). Lubricate and oil the pivotal points of the door. Run through the automatic learning cycle once again (page12).

The light doesn't work

Replace the bulb (230 V, max. 40 Watt)

The operator isn't running smooth

Unlock the carriage of the opener. Move the door manually and make sure that the door is well balanced (must come to a stop at each position). The spring tension is too high or there is even a spring fracture.

The motor is buzzing but the door doesn't move

The door is jamming.

The operator works, but the door doesn't move

The carriage is unlocked. If you want to lock it, open the door, but not completely, and let the opener run. The carriage locks in automatically.

The operator doesn't work due to a power failure

Unlock the carriage with the help of the emergency release and open the door manually. (If you have a garage where you can only enter from outside: Unlock the door with the key and turn the door-handle, then your opener will be unlocked. If you have a garage where you can also enter from inside: pull at the Bowden cable hanging from the carriage.)

EC-Declaration of Conformity

As to European Directives
Low Voltage Directive 2006/95/EC
Electro Magnetic Compatibility 2004/108/EC
im Sinne der EG-Richtlinien
Niederspannungsrichtlinie 2006/95/EC
Elektromagnetische Verträglichkeit 2004/108/EC

We, We hereby declare, that the following products comply to the mentioned EC-regulations.
Wir erklären hiermit, daß die nachfolgenden genannten Produkte den unten angegebenen EG-Richtlinien entsprechen.

in accordance with the Radio and Telecommunications Terminal Equipment Act (FTEG) and Directive 1999/5/EC (R&TTE Directive)
Gemäß dem Gesetz über Funkanlagen und Telekommunikations-einrichtungen (FTEG) und der Richtlinie 1999/5/EG (R&TTE)

We, We hereby declare, that the following products comply to the mentioned EC-regulations.
Wir erklären hiermit, daß die nachfolgenden genannten Produkte den unten angegebenen EG-Richtlinien entsprechen.

Type of Product / Produktart	Garage Door Operator / Torantrieb
Product Name / Modell	TM 50 / TM 80
Approved according to 2006/95/EC and 2004/108/EC / Geprüft nach 2006/95/EC und 2004/108/EC Referring EC-regulations: / Angewandte harmonisierte Normen:	
Electromagnetic Compatibility / <i>Elektromagnetische Verträglichkeit</i>	EN 61000-3-2 Limits for harmonic current emissions / Grenzwerte für Oberschwingströme EN 61000-3-3 Limitation of voltage changes, voltage fluctuations and flicker in publik low-voltage supply systems / Grenzwerte für Spannungsschwankungen und Flicker EN 61000-6-3 Emission standard for residential, commercial and light-industrial environments / Störaussendung für Wohnbereich, Geschäfts- und Gewerbereiche sowie Kleinbetriebe EN 61000-6-2 Generic standards - Immunity for industrial environments Fachgrundnorm - Störfestigkeit - Industriebereich
Low-Voltage Directive / <i>Niederspannungsrichtlinie</i>	EN 60335-2 Particular requirements for drives for vertically moving garage doors for residential use / Anforderungen für Antriebe von Garagentoren mit Senkrechtbewegung zur Verwendung im Wohnbereich EN 60335-1 Safety of household and similar electrical appliances / Sicherheit elektrischer Geräte für den Hausgebrauch
Safety in Use / <i>Nutzungssicherheit</i>	EN 12453 Safety in use of power operated doors, requirements / Nutzungssicherheit kraftbetätigter Tore, Anforderungen EN 12445 Safety in use of power operated doors, Test methods / Nutzungssicherheit kraftbetätigter Tore, Prüfverfahren
Forces <i>Betriebskräfte</i>	EN 13241-1 Applied for testings for Up-and-Over Doors and Sectionaldoors up to 5m wide and 2,50m high as to 06.02.2012 Prüfungen beantragt für Kipp- und Sektionaltore bis zu 5m Breite und 2,50m Höhe Stand 06.02.2012

SKR 433-1
Code B43A023004-1
Hand Transmitter as remote control for garage door operators
Handsender als Fernbedienung für Garagentorantriebe
(Short Range Device/Funkgerät geringer Reichweite (SRD))

and / und

SKR1W433
Code B443A623001
Wall Transmitter as remote control for garage door operators
Wandsender als Fernbedienung für Garagentorantriebe
(Short Range Device(Funkgerät geringer Reichweite (SRD))

comply with the essential requirements of §3 and the other relevant provisions of the FTEG (Article 3 of the R&TTE Directive), when used for its intended purpose.
bei bestimmungsgemäßer Verwendung den grundlegenden Anforderungen des §3 und den übrigen einschlägigen Bestimmungen des FTEG (Artikel 3 der R&TTE) entsprechen.

§3(1)1, (Article 3(1)a) does not refer to this type of product.
§3(1)1, Artikel 3(1)a) bezieht sich nicht auf diesen Produkttyp, es gibt hierzu keine Norm

Protection requirement concerning electromagnetic compatibility §3(1)(2), (Article 3(1)(b))
Schutzanforderungen in Bezug auf die elektromagnetische Verträglichkeit §3(1)2, Artikel 3(1)(b))

EN 300 220-1 V2.1.1
EN 300 220-2 V2.1.2
EN 301 489-1 V1.6.1
EN 301 489-3 V1.4.1
EN 60950-1:2006
EMV / EMC Directive 2006/95/EC;2004/108/EC; 99/5/EC



Myke Seip, Walzbachtal-Jöhlingen, 06.02.2012



Grombacher Straße 83
75045 Walzbachtal-Jöhlingen
Germany
www.seip.com