

EN Garage door drive RolloPort S2

Translation of the Original Operating and Assembly Manual

Item no: 4201 70 61 / 4202 70 61

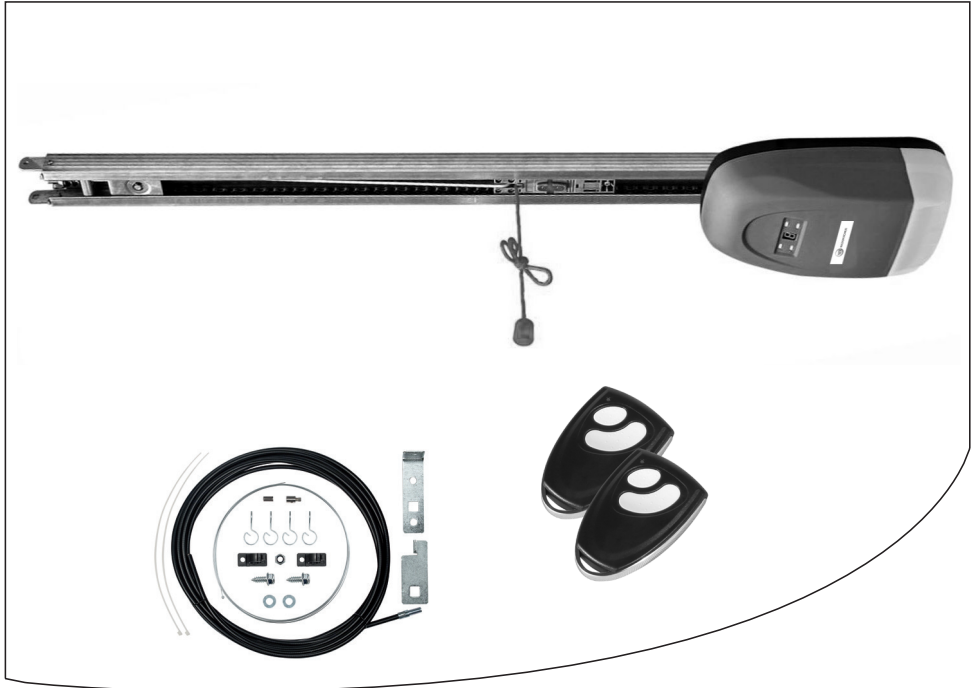

i Dear Customers...

...with your purchase of this **garage door operator**, you have decided for a quality product manufactured by RADEMACHER. We would like to thank you for your confidence.

The new **RADEMACHER garage door operator** has been designed in an effort to the greatest possible ease of operation. With uncompromising quality requirements, after extensive test series, we are proud to present this innovative product to you.



All of our highly qualified staff at RADEMACHER stand behind this product.

i These instructions...



...describe how to install, connect and operate **the RolloPort S2**.
Before you begin work, please read

these instructions all the way through and follow all of the safety instructions.

Please save these instructions and give them to any future owners.

For damage resulting from noncompliance with these instructions and safety instructions, the guarantee is void. We assume no liability for any consequent damage.

i Key to Symbols



Danger of fatal electric shock

This sign warns of danger when working on electrical connections, components etc. It requires that safety precautions be taken to protect the health and life of the person concerned.



This concerns your safety

Please pay particular attention to and carefully follow all instructions with this symbol.



This symbol advises of malpractices that can cause damage to people and property.

NOTE/IMPORTANT/CAUTION

This is to draw your attention to information which works is important to ensure trouble-free operation.

Dear Customers.....	2	Programming	21
These instructions.....	2	Setting limits / setting the upper limit	22
Key to Symbols	2	Setting the lower limit	22
General View	4	Carry out reference run for power measurement	23
Supply package.....	5	Adjust power limiting as required.....	24
Safety instructions	6	Alarm setting	25
Proper use	7	Automatic closing time setting	25
Operating conditions.....	7	Automatic closing time setting	26
Improper use	8	2000 cycle alarm setting.....	26
Admissible garage door types	8	Conclude programming.....	27
Inadmissible types of garage door	8	Registering and de-registering hand transmitters	28
Functional description	9	Connecting additional electrical equipment.....	29
Functional description/emergency release	9	Manual door operation	30
Functional description / Recognition of obstructions ..	10	Instructions for the user	31
Monthly checks on the obstacle recognition (power limiting)	10	Normal operation.....	31
Maintenance	11	Technical Specification	32
Important installation instructions.....	12	Trouble shooting	33
Required tools	13	Simplified EU Declaration of Conformity	34
Remove the door locks	13		
Take measurements	14		
Assembly of the rails	15		
Tension the drive chain	15		
Connect the door operator housing to the rail.....	16		
Attachment of the door operator and the rail.....	17		
(A) Installation of the header bracket (1)	18		
(B) Installation of the fixing bracket (5) at the door operator head (7)	18		
(C) Installation of the door bracket (8)	19		
(D) Installation of the middle support clip (13)	20		
(E) Installation on the ceiling with perforated brackets	20		
Important notes after installation.....	21		
Attach safety notices with warning messages	21		
Establish operational readiness of the door	21		

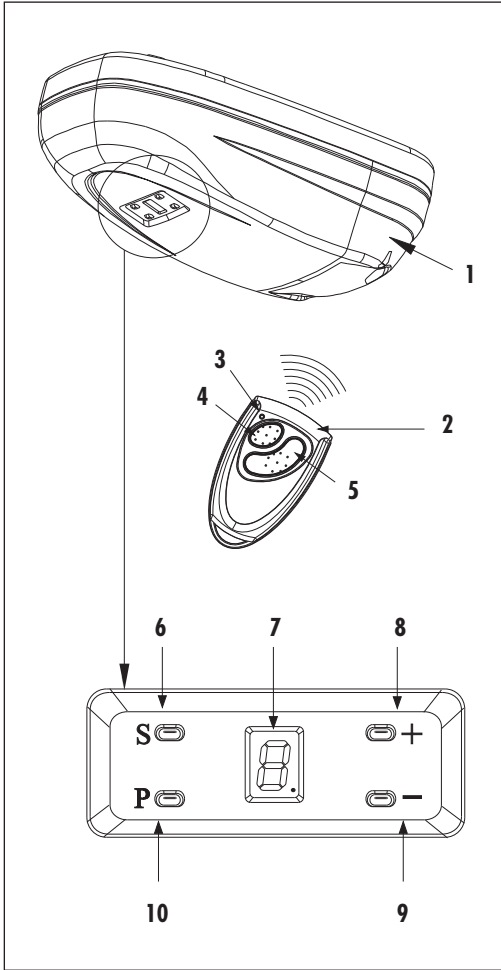

Key

- 1 = Operator, including lighting
- 2 = Hand transmitter
- 3 = LED
- 4 = 1st hand transmitter button
- 5 = 2nd hand transmitter button
- 6 = Set button (S)
- 7 = Display
- 8 = Button for adjustment (+)
- 9 = Button for adjustment (-)
- 10 = Programming button (P)

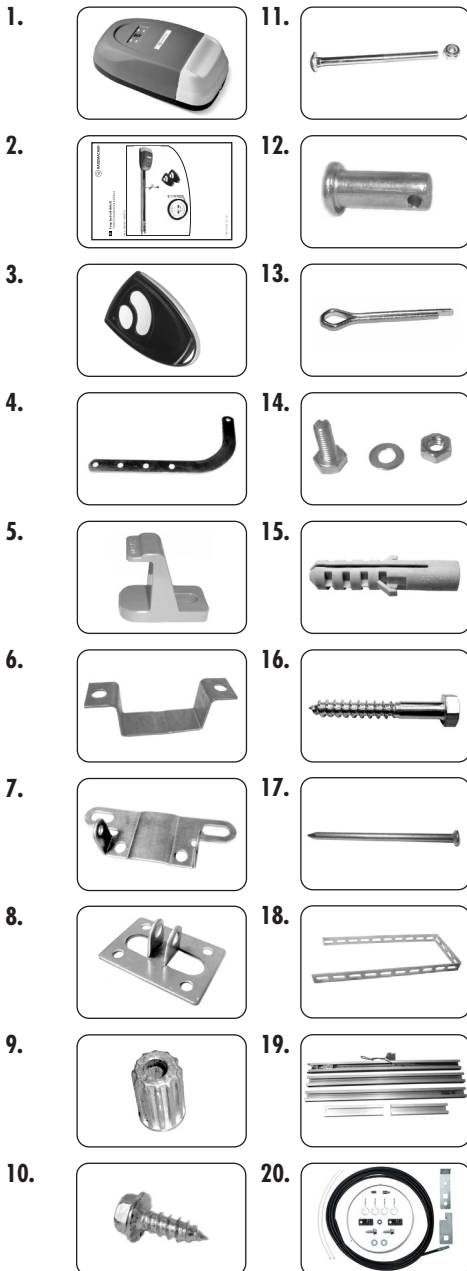

Please compare the contents of the package with the content description on the packaging:

1. 1 x Drive
2. 1 x Operating instructions
3. 2 x Micro hand transmitter
4. 1 x Door connector, bent
5. 2 x Middle support clip
6. 3 x Fixing bracket
7. 1 x Header bracket
8. 1 x Door bracket
9. 1 x Connector
10. 8 x Self-tapping hexagon screw (6 x 15 mm)
11. 1 x Screw (6 x 80 mm) with hexagon nut
12. 1 x Bolt (8 x 20 mm)
13. 1 x Securing bolt (2 x 20 mm)
14. 4 x Screw (8 x 20 mm) with hexagon nut and plain washer
15. 6 x Wall plug (10 mm)
16. 6 x Hexagon head screw (8 x 60 mm)
17. 1 x Spike
18. 2 x perforated brackets
19. 3 x Rails + 2 x Connectors
20. 1 x External release

i Safety instructions



Failing to observe all of the information and safety instructions contained in this manual can lead to severe personal injury, e.g. by being trapped by the door.

Follow all of the information in this operating and assembly manual in order to comply with the safety regulations in standards EN 13241-1, EN 12445 and EN 12453 and only operate the door system in accordance with the standard once it has been inspected by a qualified engineer.



All work performed on electrical equipment is associated with a risk of electric shock and electrocution.

- ◆ Have all work on electrical equipment and on the door operator carried out by a qualified electrician.
- ◆ Always remove the mains power adapter from the socket before performing any work on the door or the door drive (e.g. cleaning, maintenance or the replacement of parts).



The use of defective devices can put people and property at risk.

- ◆ Never use faulty or damaged devices.
- ◆ Please make sure that the door operator and mains cable are free from damage.
- ◆ If the power cable is damaged, it must be replaced by the manufacturer, its service agent or similarly qualified persons in order to avoid a hazard.
- ◆ Please notify our customer service department (see page 36) of any faults or damage to the device.



Faulty doors can result in injuries.

- ◆ The operation of the door must not be hindered by badly adjusted springs or poorly functioning door installation or door constructions.
- ◆ There is a risk of injury due to the tightly stretched door springs. Never replace the door springs yourself.
- ◆ Have all work on the door mechanics and the springs carried out by a qualified person.



Power-driven doors entail the risk of crushing and shearing at the closing edge.

- ◆ Ensure that during operation there are no persons in the swivelling range of the garage door.



Improper use increases the risk of injury.

- ◆ Never reach into the moving door or into moving parts.
- ◆ The door should never be operated out of sight without additional safety equipment (e.g. light barrier), see page 29.
- ◆ Instruct all persons who operate the garage door in the safe use of the equipment.
- ◆ This device may be used by children from 8 years of age upwards as well as by persons with reduced physical, sensory or mental capacities or with lack of experience and knowledge if they are supervised or have been instructed on how to use the device safely and if they understand what dangers may result from this.
- ◆ Do not allow children to play with the device or with the hand transmitter.
- ◆ Please store the hand transmitter in such a way that it cannot unintentionally be operated by, e.g. playing children.
- ◆ Cleaning and user maintenance may not be carried out by children without supervision.
- ◆ Do not allow anyone to go through under the moving door.
- ◆ Keep children away when the door is moving.
- ◆ Drive in and out of the garage only when the door is fully open and stationary.



In the case of defective or inoperable safety equipment there is a danger of injury or damage to property.

- ◆ Before first operation and thereafter one month inspect the correct functioning of the safety equipment (e.g. the power limiter).
- ◆ Never switch off the safety equipment.
- ◆ Keep the door limit stop on the ground free of ice, snow, dirt and stones.

i Safety instructions

Opener service life is 25.000 cycles.

Each steel wire rope shall have a safety factor not smaller than 6 (minimum breaking strength / static load of one rope).

Rope drums shall have a pitch circle diameter (PCD) at least equal to 20 times the rope diameter.



Important safety instructions.

It is important for the safety of persons to follow all instructions. Save these instructions.

i Proper use

Use the garage door operator only:

- ◆ to open and close garage doors
- ◆ for private use
- ◆ according to the instructions and safety regulations in this manual

Any other use shall be regarded as non-compliant with the intended use.

Correct use of the hand transmitter

The remote control via hand transmitter is only admissible for appliances and equipment in which radio interference in the transmitter or receiver does not present a hazard for persons, animals or property or for which the risk is covered by other safety equipment.

Comply with all maintenance intervals

Proper use also includes the regular inspection of the door and its safety equipment.



Failing to observe all of the information contained in this manual can lead to severe personal injury, e.g. by being trapped by the door.

Pay attention to all of the information. In order to comply with the safety regulations in standards EN 13241-1, EN 12445 and EN 12453, it is particularly important that this operating and assembly manual is followed during the installation process.

i Operating conditions

- ◆ Only operate the garage door operator in dry rooms.
- ◆ The garage door must be able to be opened and closed easily by hand and must not jam.
- ◆ Ensure that the overhead ceiling tracks are always free of grease and dirt. Dirty overhead ceiling tracks hinder proper operation.
- ◆ A 220 - 240 V/50 - 60 Hz power supply must be available at the place of installation.

i Improper use



Incorrectly performed structural alterations result in the risk of injury.

Do not carry out any structural alterations to the door operator, the garage door or any existing safety equipment which deviate from the measures described in this manual. Such alterations endanger the operating safety.

The garage door operator must not be used:

- ◆ in commercial establishments
- ◆ to operate other objects
- ◆ in continuous operation



Watch the moving door and keep people away until the door is completely opened or closed.



Warning

- ◆ The drive shall be disconnected from its power source during cleaning, maintenance and when replacing parts.
- ◆ The drive must not be used with a door incorporating a wicket door without monitoring.
- ◆ If re-adjustment does not restore the correct operation, call for authorised service.



If a wicket door is installed, the door position must be monitored. It must be ensured that the drive is not active if the door is not closed.

i Admissible garage door types

- ◆ swing out standard up-and-over doors
- ◆ sectional doors

The doors must move smoothly and comply with the regulations of the following standards: EN 12453 and EN 12604.

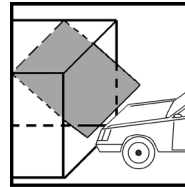

Up-and-over doors

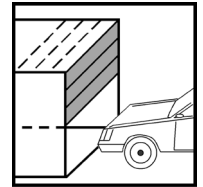

Ceiling sectional doors

i Inadmissible types of garage door



Doors which require tilting and rotating movements may not be operated with the type S2 garage door operator.

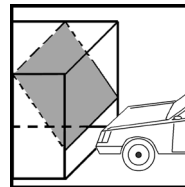

Non swinging out retractable up-and-over door

i Functional description

Intelligent microcomputer

Intelligent, computerized, exact positioning of travel, prompt power determination, reverses if obstructions are met.

Door operator

Low noise, soft start and soft stop protect the motor and ensure a long service life.

Self diagnosis

Operational mode and digital menu shown on the display, self diagnosis (L-Normal, F/H-Electronic error, A-Infrared Ray Interrupted).

Cryptoguard

Rolling code technology provides billions of code combinations and makes every remote control a unique one that protects against unauthorized access.

Alarm unit

The alarm sounds when the door is left open for longer than 10 minutes. The alarm stops when the door is closed again (refer to „Alarm setting“ on page 25).

Emergency release device

The door can be manually operated by pulling down on the emergency release cable in the case of power failure.

Automatic closing function

The automatic closing time of the door can be set from 30 to 240 seconds (refer to page 25/26).

2000 cycle alarm

When the operator has run 2000 cycles, it will beep to remind the user to service the mechanical system (refer to page 26).

Lighting

The S2 garage door operator has internal lighting which is switched on after each switching impulse and goes off again automatically after 3 minutes.

Additional connecting options for external accessories and safety unit

In addition you can connect an external switch and an infrared photoelectric barrier (refer to page 29).

i Functional description/emergency release

In the event of a power cut, the door can be operated manually by pulling the emergency release cable.



There is a risk of injury. The door can fall uncontrollably when it is released (e.g. if the door is not balanced).

- ◆ Always close or open the door fully after each release.
- ◆ The emergency release is not intended for „everyday use“.

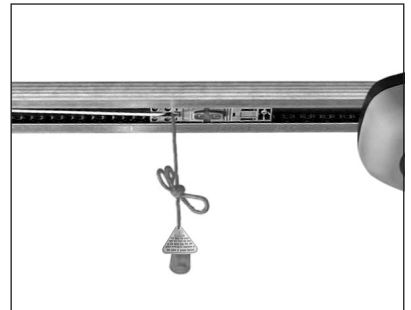

The door operator has an automatic obstacle-recognition system (through internal monitoring of power).

If the door encounters an obstruction when closing or opening, the door operator stops the door automatically and moves it in the opposite direction until it reaches the corresponding limit.

After removing the obstruction you can operate the garage door operator normally again.

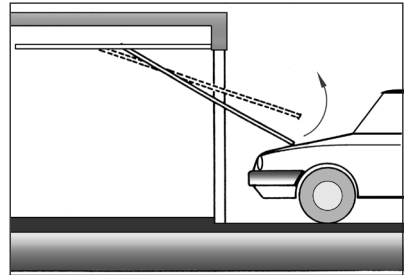

Monthly checks on the obstacle recognition (power limiting)

1. Run the door into the final open position.
2. Place a 50 mm high object, e.g. a wooden block, in the direction of travel of the door.
3. Close the door by actuating the hand transmitter.
4. If the door hits an obstruction when closing, the door operator automatically stops and opens the garage door fully.
5. After this, remove the obstruction.
6. After removing the obstruction, you can operate the garage door operator normally again.

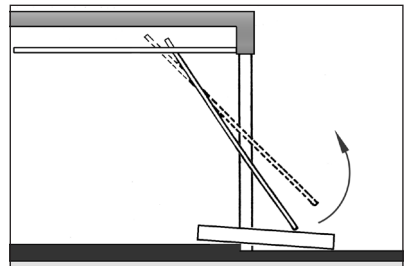

Placing an approx. 50 mm wooden block in the direction of travel of the door.



If necessary, correct and check the alignment once again, as an incorrect alignment cause pose a threat, see page 24.

◆ If the subsequent adjustment does not restore correct operation, please contact our authorised Service department.



Defective door systems and safety equipment result in the risk of injury.

For your safety, you should comply with the recommended maintenance intervals for your door system, including all safety equipment.

Maintenance interval:

Have the door system inspected by a specialist company before initial operation and then as required, but at least once a year.

Regular checks of wearing parts:

There is a risk of injury due to defective or worn components.



Check the system therefore regularly for signs of wear, damage or lack of balance of the door.

Do not use the door under any circumstances if repairs or adjustments need to be made.

Check:

- ◆ All screw connections to ensure they are tight
- ◆ Cables for damage
- ◆ Springs and fixing parts



There is a risk of injury due to the extremely taut door springs.

- ◆ Never replace the door springs yourself.
- ◆ Have all work on the mechanical system and springs carried out by a qualified person.



Important instructions for a safe installation. Follow all installation instructions carefully.

An incorrect installation can lead to serious injuries.



Before installation check...:

- ◆ ...whether your door operator is suitable for the type of garage door and the garage door height.
- ◆ ...that the door is in a perfect mechanical state. The door must be smooth running and be balanced. Check whether it opens and closes properly;
Open the door approx. 1 metre and let go. A balanced door should now remain in this position. If not, have your door adjusted by a specialist company.
- ◆ The door operation must not be hindered by incorrectly adjusted springs or by incorrectly functioning door suspensions or door constructions.

Before installing the drive...,

- ◆remove all unnecessary ropes or chains and disable any equipment, such as locks, not needed for powered operation.



During installation there is a danger of injury due to the unsecured door falling suddenly.

- ◆ During the installation work, ensure that there are no persons in the swivelling area of the garage door.



Faulty installation can result in serious accidents and injuries.

- ◆ Fit the actuator for the emergency release at a height of less than 1.8 metres.
- ◆ Use only the enclosed mounting materials and only original spare parts and original accessories.
- ◆ Any existing door locking devices already fitted to the door may hinder the correct functioning of the door and must therefore be removed.
- ◆ Movable parts of the garage door must not extend into public footpaths or cycle paths.
- ◆ Poor lighting hinders the installation work and can result in injuries. Ensure that there is adequate lighting during installation work.
- ◆ It is possible that during the installation work, you may not be able to open the door for a short period of time.
- ◆ This drive is not to be used with doors having openings exceeding 50 mm in diameter or having edges or protruding parts a person could grip or stand on.
- ◆ Permanently fix the label concerning the manual release adjacent to its actuating member.
- ◆ Attach all labels so that they are clearly legible.
- ◆ The manufacturer is not liable for damage which occurs due to incorrect or non-compliant use (see warranty conditions).



Required tools

EN

You require the following tools

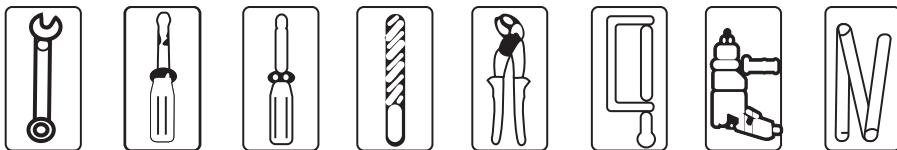

Remove the door locks

1. Remove all vertical and horizontal door locks and catches.

IMPORTANT!

Keep the „old“ door locks in a safe place.

In the event that you should remove the garage door operator, you will have to fit these again in order to restore the original state of the door.

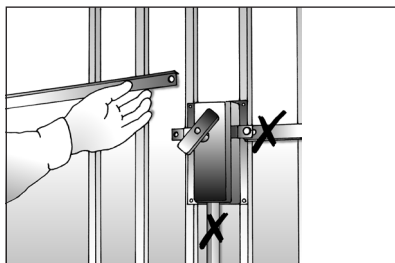



1. Measure up and mark the centre of the door

Mark the centre of the door, as shown, on the upper edge of the door, on the door lintel and on the garage ceiling.

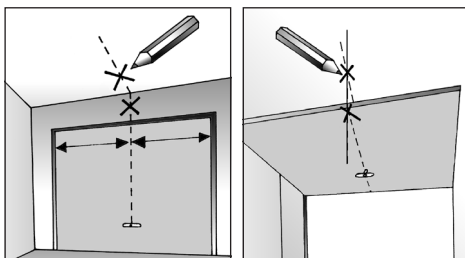

2. Determine the distance between the top edge of the door and the ceiling

Close the door slowly and measure the distance between the top edge of the door and the ceiling.

NOTE

The minimum distance should be 6 cm.

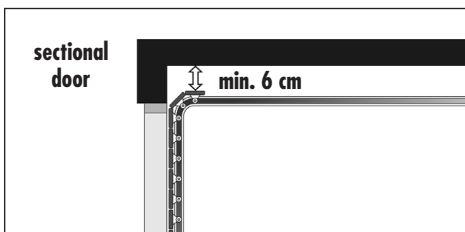
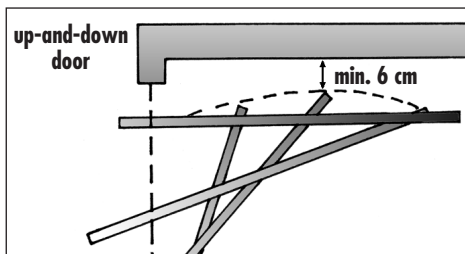

3. Installation advice for fitting to sectional doors

If the garage door operator is used for a sectional door, then the guide roller of the upper door segment must be in the bend of the guide rail when the door is closed.

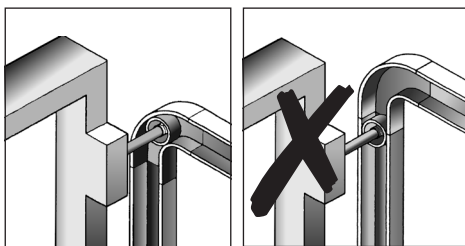

Right

Wrong



Assembly of the rails

EN

NOTE

The RolloPort S2 is supplied with three rails:

- ◆ two end pieces, including a pre-assembled chain
- ◆ a middle piece (without a chain) with two connectors

1. Lay the two end pieces with the pre-assembled chain on the ground, with the chain lying as straight as possible between the two end pieces.
2. Push the two enclosed connectors onto the middle piece and then lay the middle piece in the gap between the two end pieces.
3. Insert the chain into the middle piece.
4. Push each of the connectors onto the join between the middle piece and each of the end pieces.

Please ensure that each of the connectors lies in the centre between the fixing plates of the rail underside.

5. Finally, bend the fixing plates outwards with a small screwdriver.

As a result, the connectors can no longer be moved.

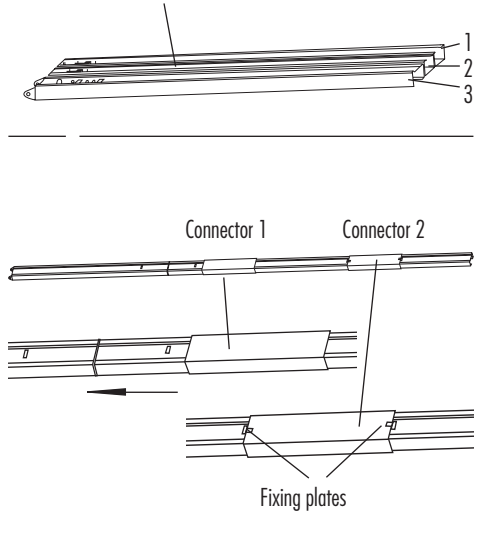

Tension the drive chain

1. Screw the clamping nut tight with a suitable socket key ($\varnothing 10$ mm).
2. Adjust the tension of the chain as shown in the picture.

NOTE! Due to manufacturing tolerances, the shown range of approx. 36 - 38 mm can vary.

Make shure that the chain sags a little on the full length of the rail, so that it is not streched too tight. Otherwise it can result in a loss of power the drive.

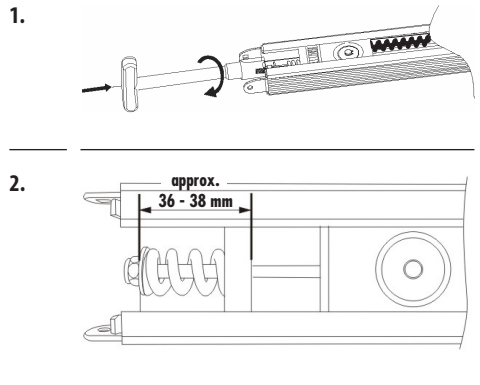



Connect the door operator housing to the rail

EN

1. First of all insert the connector (5).
2. Place the rail (4) with the inboard chain sprocket (supplied pre-assembled in the rail) over the connector (5).
3. Place the two fixing brackets (2) over the rail (4) and screw these firmly onto the door operator housing with the enclosed self-tapping hexagon screws (6 x 15 mm).

IMPORTANT

Ensure that the microswitch (3) is not damaged when mounting the rail.

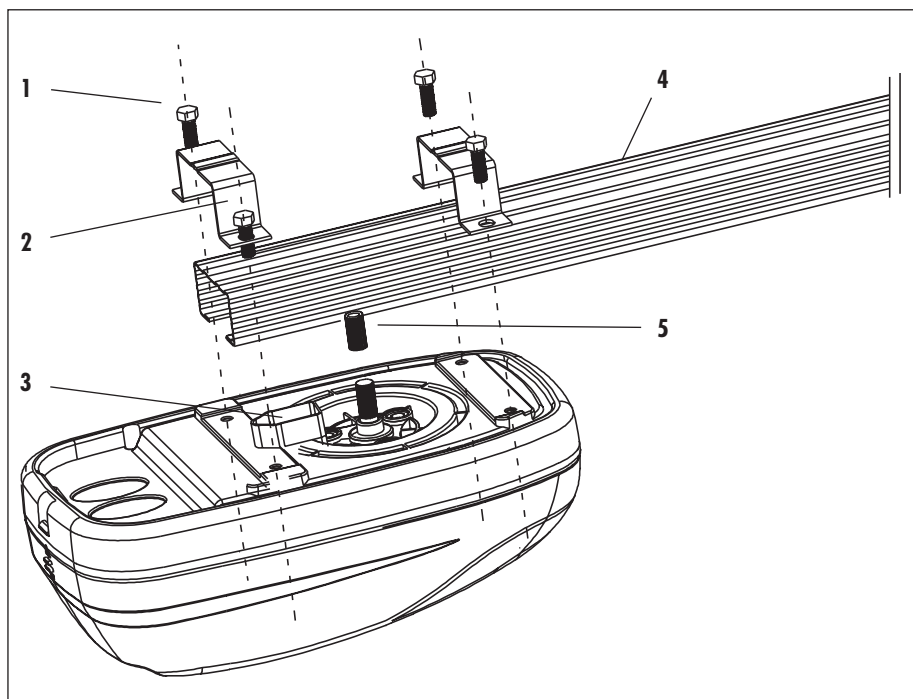

Key

- 1 = Self-tapping hexagon screw (6 x 15 mm)
- 2 = Fixing brackets
- 3 = Microswitch
- 4 = Rail
- 5 = Connector

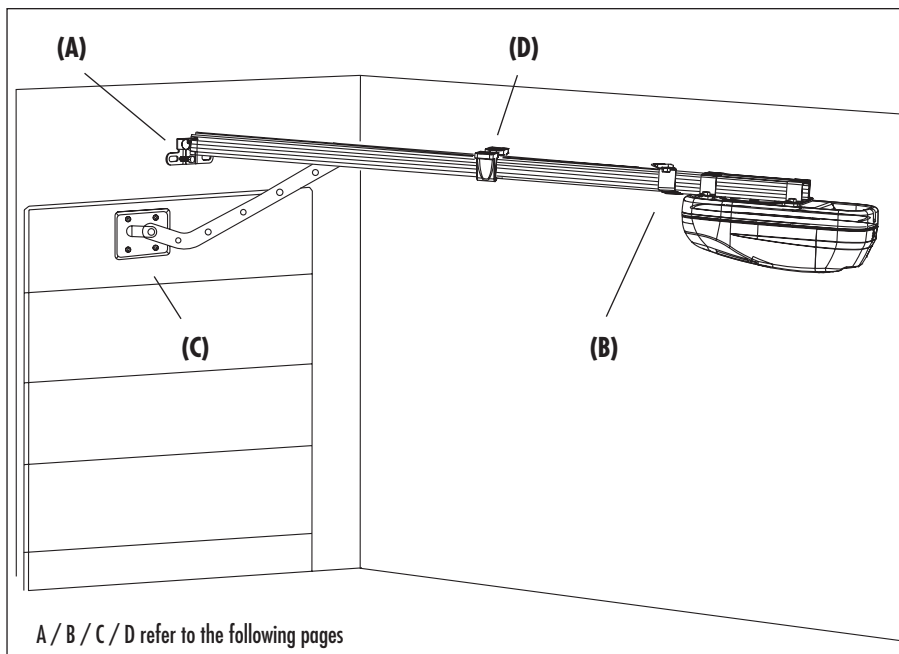

Installation on the lintel

The installation should preferably be on the lintel, as this means that the forces encountered can best be absorbed.

Installation on the ceiling

For installation on the ceiling, you should rotate the header bracket by 90 degrees and fix it to the ceiling further inward. The full rail length can then be used as a result.

NOTE

When fitted to the ceiling, the distance to the door leaf must be a maximum of 25 cm. Otherwise perforated brackets must be used, see page 20, chapter "(E) Installation on the ceiling with perforated brackets".

IMPORTANT

In the case of garage walls or garage ceilings made of stone (concrete), use the enclosed hexagon screws (8 x 60) and wall plugs \varnothing 10 mm.

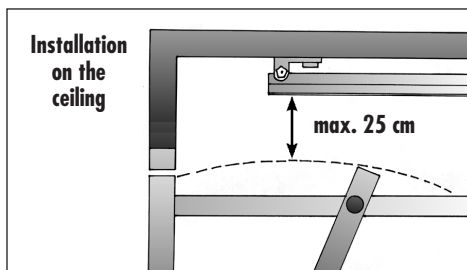
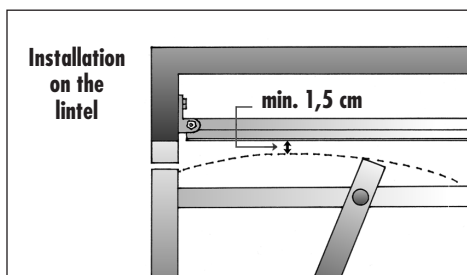



(A) Installation of the header bracket (1)

EN

NOTE

The header bracket (1) must be aligned with the mid-point of the door.

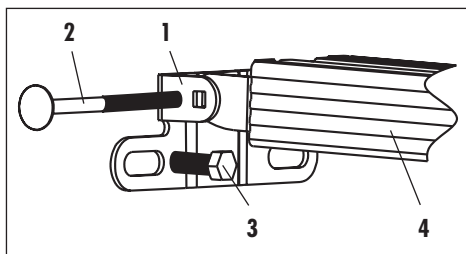

1. **Mark out the position of the header bracket (1) and drill the mounting holes (e.g. with a 10 mm masonry drill bit).**
2. **Screw the header bracket (1) tight with the enclosed hexagon screws (8 x 60 mm).**
3. **Then fix the rail (4) with the enclosed hexagon screw (6 x 80 mm) to the header bracket (1).**

Key

- 1 = Header bracket
- 2 = Screw (6 x 80 mm) with hexagon nut
- 3 = Hexagon screw (8 x 60 mm)
- 4 = Rail



(B) Installation of the fixing bracket (5) at the door operator head (7)

1. **Push the fixing bracket (5) onto the rail (4), as close to the door operator head (7) as possible.**
2. **Mark the mounting holes for the fixing bracket (5).**

In order to do so, lift the entire construction and push it against the ceiling.

NOTE

Ensure that the rail (4) is aligned with the centre of the door.

3. **Drill the mounting holes (e.g. with a 10 mm masonry drill bit).**
4. **Finally screw the fixing bracket (5) to the garage ceiling with the enclosed hexagon screws (8 x 60 mm).**

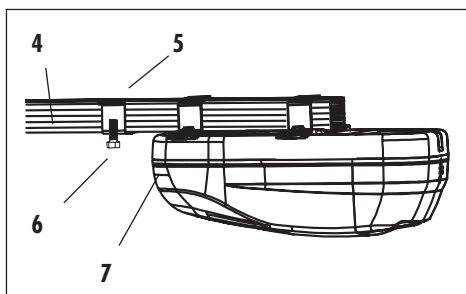

Key

- 4 = Rail
- 5 = Fixing bracket
- 6 = Hexagon screw (8 x 60 mm)
- 7 = Door operator head



(C) Installation of the door bracket (8)

EN

NOTE

We recommend fixing the door bracket (8) to the door frame if possible.

For plastic or thin-walled wooden doors, additional cross-beams are necessary in order to avoid damaging the door. In this case, consult your door supplier.

Use existing drillholes, if possible, to mount the door bracket (8).

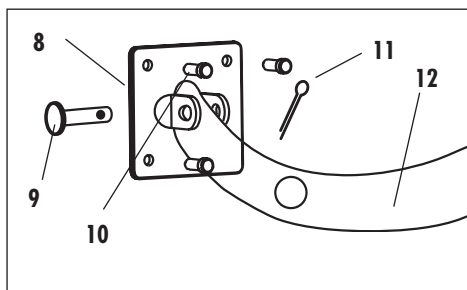

Key

- 8 = Door bracket
- 9 = Bolt (8 x 20 mm)
- 10 = Self-tapping hexagon screw (6 x 15 mm)
- 11 = Securing bolt (2 x 20 mm)
- 12 = Door connector, bent

1. Place the door bracket (8) on the top edge of the garage door and align it with the centre of the door (in a line with the profile slide). Next, mark the four fixing holes on the door frame.



2. Punch in the fixing holes in the door frame with the aid of the enclosed spike

NOTE

Self-tapping screws need sufficient hold in the material. Check the thickness of your door frame. If it is sufficiently thick you can also pre-drill the fixing holes with a 4 mm metal drill bit if you are not able to punch in the holes with the spike.

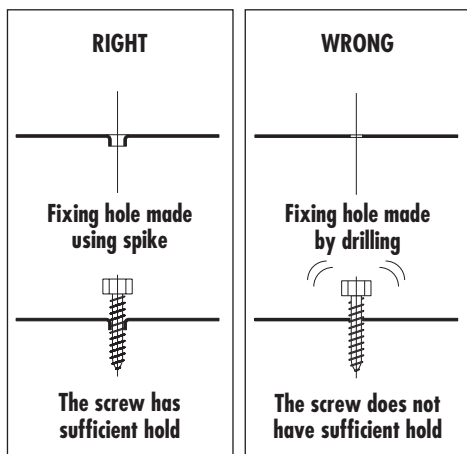



(C) Installation of the door bracket (8)

EN

3. Screw the door bracket (8) tight with the enclosed self-tapping hexagon screws (8 x 15 mm).
4. Finally, fix the door connector (12) to the door bracket (8) with the enclosed bolt (9).

NOTE

A straight door connector is supplied pre-assembled, and this is permanently fixed to the rail.

If you wish to use the bent door connector (12) enclosed (depending upon your door particular configuration), you must attach this with two hexagon screws (8 x 20) to the straight door connector.

5. Finally, secure the bolt (9) by attaching the securing bolt (11) to prevent it from slipping out.

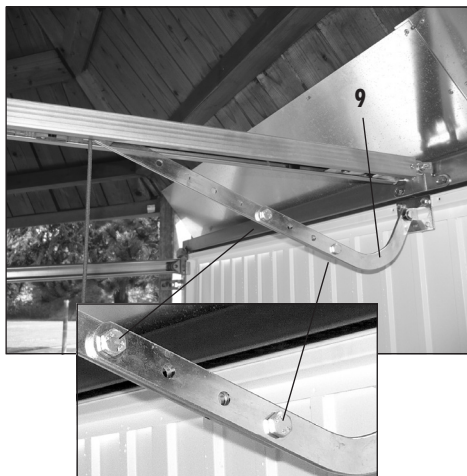

(D) Installation of the middle support clip (13)

1. Fit the middle support (13) clip at a suitable place, as near as possible to the middle point between the door and the door operator head.

Key

- 13 = Middle support clip
14 = Hexagon screws (8 x 60 mm)

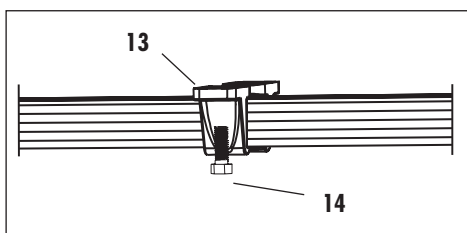

(E) Installation on the ceiling with perforated brackets

If mounting directly on the ceiling is not possible due to the ceiling height being too high, the perforated brackets must be used for the suspension because there is a distance of more than 25 cm between the highest point of the door and the rail.

To do this, bend the brackets to the desired length and then connect them to the mounting bracket and the centre suspension.

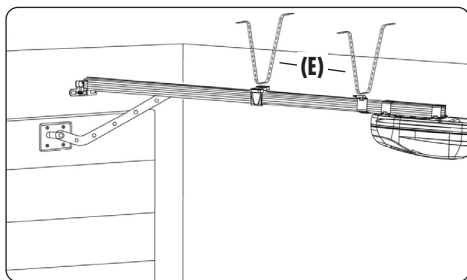



Important notes after installation



- ◆ After installation, ensure that the mechanism is properly adjusted and that the drive reverses when the door contacts a 50 mm high object placed on the floor (for drives incorporating an entrapment protection system depending on contact with the bottom edge of the door), s. page 10.
- ◆ After installation, ensure that the drive prevents or stops the opening movement when the door is loaded with a mass of 20 kg, fixed centrally on the bottom edge of the door. This applies especially to drives which can be used with a door that has openings in the door leaf larger than 50 mm in diameter.



Attach safety notices with warning messages

Improper use results in an increased risk of injury.

- ◆ Before initial operation, attach the enclosed safety notices to suitable places on your garage door and on the profile slide.
- ◆ Attach all notices so that they are clearly legible.



Establish operational readiness of the door

1. **Move the door carefully, in order to engage the profile slide.**
2. **Plug the mains plug into the socket and switch on the electricity.**
3. **The light goes on and the unit gives a single beep and the display shows '0' at regular intervals.**



Programming



In order that the following settings are correctly stored and executed, you must carry out a final programming procedure according to page 27.



Setting limits / setting the upper limit

EN



Carrying out the instructions in the wrong order when setting the limits will result in malfunctions. Be sure to keep to the setting order specified.

Correct setting order:

1. Set upper limit
2. Set lower limit

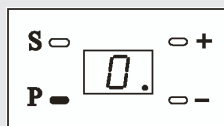

1. Press „P” for approx. 5 seconds.

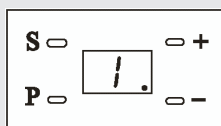

2. The door operator beeps and shows „1”.

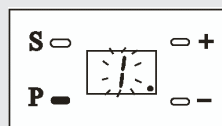

3. Press „P”, „1” flashes.

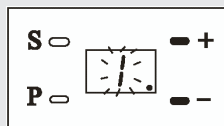

4. Press „+” or press „-”.



5. The door opens or closes.

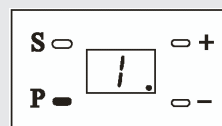

6. If the door has moved upwards to the required position, press „P” to store the upper limit.



Setting the lower limit

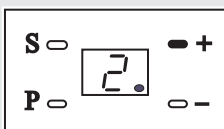

1. Press „+”, the display shows „2”.

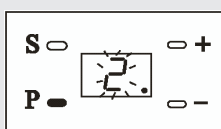

2. Press „P”, „2” flashes.

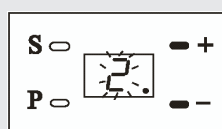

3. Press „+” or press „-”.



4. The door opens or closes.

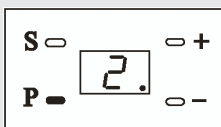

5. If the door has moved downwards to the required position, press „P” to store the lower limit.



Carry out reference run for power measurement

EN



During the reference run there is a risk of injury, as the door operator develops extremely strong forces.

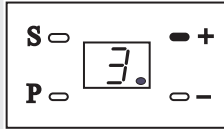

1. Press „+“, the display shows „3“.

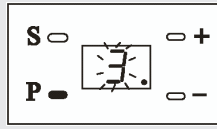

2. Press „P“, „3“ flashes.

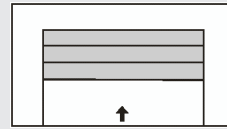

3. The door goes up automatically.

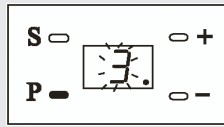

4. After it has stopped, press the „P“ button twice.

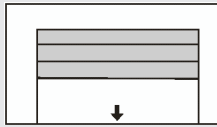

5. The door goes down.

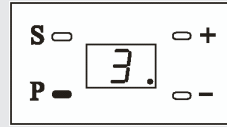

6. After it has stopped, press „P“, to store the information.

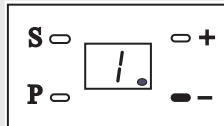

7. Conclude the programming (refer to page 27, method 1).

IMPORTANT

Once you have set the two limits and the reference run for power measurement, you have fulfilled the basic settings required for safe operation.

If you do not require any further settings, you must conclude programming as specified in **method 1** on page 27, in order to adopt the basic settings you have just programmed. -

After this, you can conclude the following individual settings, either singly or after all the settings have been programmed, using **method 2** on page 27.



Adjust power limiting as required

EN

NOTE

The door operator is preset to stage 3 by the supplier. If required (e.g. if the power level is too low) you can subsequently adjust the power limiting setting.



If the power level is too low, the door movement will be impaired, particularly if the mechanical structure of the door is not well balanced.

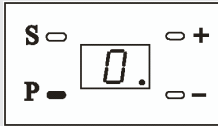

1. Press „P“ for approx. 5 seconds.

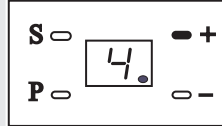

2. Press „+“ (if necessary press several times) until „4“ is displayed.

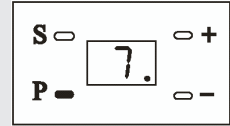

3. Press „P“, the display shows „7“ (stage 3).

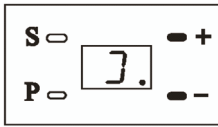

4. Press „+“ or press „-“ to select the stage.

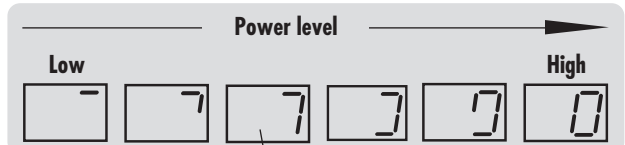

Factory setting

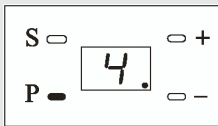

5. Press „P“, in order to store the setting.

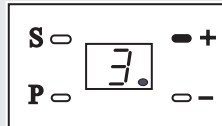

6. **IMPORTANT**
Repeat reference run for power limiting (refer to page 23).

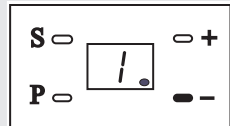

7. Conclude programming (refer to page 27, method 1).



After a resetting of the power level, it is absolutely necessary to repeat the reference run for power limiting and to conclude the programming again.

- ◆ During the reference run there is a risk of injury as the door operator develops extremely strong forces.
- ◆ If the subsequent adjustment does not restore correct operation, please contact our authorised Service department.



Alarm setting

EN

If the alarm is switched on, the door operator beeps if the door is open for longer than 10 minutes. The door operator beeps for 30 seconds every 10 minutes.

To end the beeping:

Press the door control button to fully close the door.

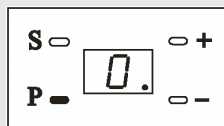

1. Press „P“ for approx. 5 seconds.

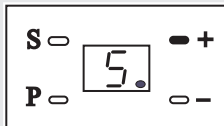

2. Press „+“ (press several times if necessary) until „5“ is displayed.

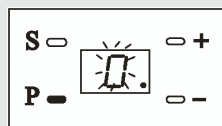

3. Press „P“, the display is „0“.
(0 = off = factory setting)

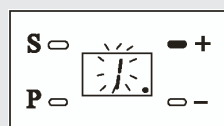

4. Press „+“, the display is „1“.
(1 = on = the alarm setting is switched on)



5. Press „P“ in order to store the alarm setting.

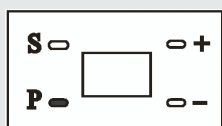

6. Conclude programming (refer to page 27, method 2) or proceed with next setting.



Automatic closing time setting

NOTE

Before the door closes automatically, the door operator beeps for 20 seconds. At the same time the light flashes.

When the door starts closing, the light shines durably and it beeps permanently.

After the door has closed, the door operator ends the beeping and the light remains on for a further 3 minutes.

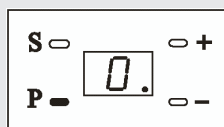

1. Press „P“ for approx. 5 seconds.

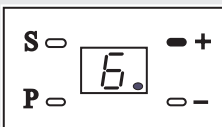

2. Press „+“ (press several times if necessary) until „6“ is displayed.

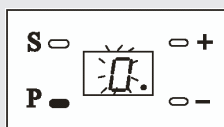

3. Press „P“, the display is „0“.
(0 = off = factory setting)

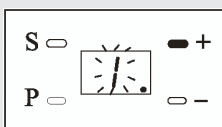

4. Press „+“, the display is „1“.
(1 = on = automatic closing time = 30 seconds)

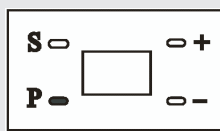
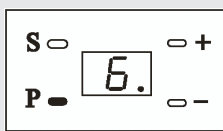
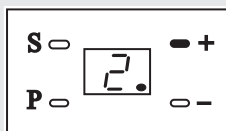

5. Press „+“ and select the required closing time:

- | | |
|--------------|--------------|
| 1 = 30 sec. | 5 = 150 sec. |
| 2 = 60 sec. | 6 = 180 sec. |
| 3 = 90 sec. | 7 = 210 sec. |
| 4 = 120 sec. | 8 = 240 sec. |
- (maximum)

6. Press „P“ in order to store the setting.

7. Conclude programming (refer to page 27, method 2)
or
proceed with the next setting.



2000 cycle alarm setting



After a period of time in use, regularly check to see whether the door is level when opening/closing, and whether the spring has enough force to raise the door.

Add a suitable amount of lubricant to all moving parts regularly.

NOTE

If this function is activated, after 2000 cycles the door operator will indicate with a short whistling tone at regular intervals that door maintenance must be carried out.

To end the alarm tone

Switch the power supply off and then on again, or press the „P“ button for the door for 5 seconds.

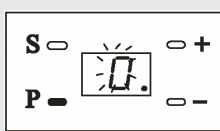
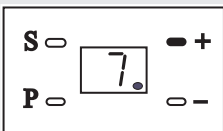
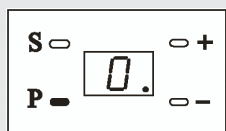

1. Press „P“ for approx. 5 seconds.

2. Press „+“ (press several times if necessary) until „7“ is displayed.

3. Press „P“, the display is „0“.
(0 = off = factory setting)

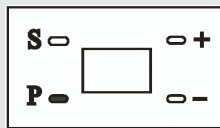
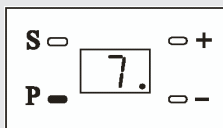
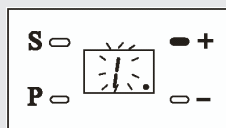

4. Press „+“, the display is „1“.
(1 = on)

5. Press „P“ in order to store the setting.

6. Conclude programming (refer to page 27, method 2) or proceed with next setting.



IMPORTANT

Please note: this concluding step must be carried out, otherwise the information stored will be lost.

NOTE

You can conclude the programming in two ways:

Method 1: Carry out this method without fail after the reference run.

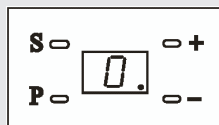
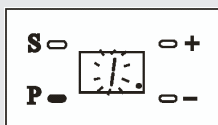
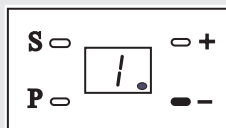

1. After the reference run, press „-“ (press several times if necessary) until „1“ is displayed.
2. Keep „P“ pressed for 5 seconds.
3. „0“ will be displayed at regular intervals in order to conclude the programming and set the door operator into an idle state.

Method 2: After all other settings

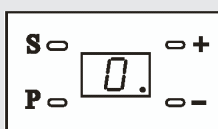
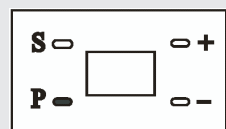

1. After completing any setting, press „P“ for 5 seconds.
2. „0“ will be displayed at regular intervals in order to conclude the programming and set the door operator into an idle state.



Registering hand transmitters:

Both manual transmitters are already logged on to the large button on the garage door drive when in the factory. If you want to log on another manual transmitter, or have already logged off a manual transmitter that is included in the scope of supply and want to log it on again, proceed as follows.

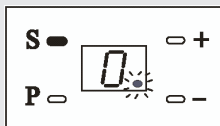
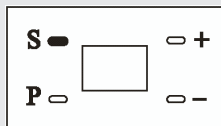

1. Press „S“ for 2 seconds and then let go.
2. As acknowledgement, a green point will appear for a short time at the bottom right of the display.
3. Press twice the button on the manual transmitter you want to use to operate the garage door drive. A signal tone is emitted by the drive during the log-on process by way of confirmation.

NOTE

After successfully registering you can operate your garage door operator with the hand transmitter. After that you can also register further hand transmitters. You can register a maximum of 16 additional transmitters.

De-registering hand transmitters:



For security reasons, a hand transmitter must be de-registered in the event of loss, to prevent the garage door from being operated by unauthorised persons.

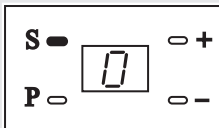
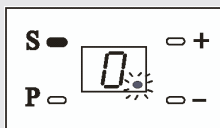
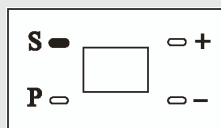

1. Press „S“ and keep pressed.
2. As acknowledgement, a green point will appear for a short time on the bottom right of the display.
3. Keep „S“ pressed until the green point at the bottom right of the display disappears.
All hand transmitters are de-registered. You can register a new hand transmitter.

i Connecting additional electrical equipment



When working on electrical systems there is a risk of danger to life due to electrocution.

- ◆ The connection of additional electrical equipment must only be carried out by a qualified electrician.
- ◆ Before opening the protective cover always disconnect the equipment from the mains power supply and check that the system is free of voltage.



Accessories from other manufacturers may result in malfunctions or damage to property.

- ◆ Use only original accessories. A separate source voltage at the screw-type terminal for the external switch will result in a short circuit and will destroy the door operator's electronics.



If the external buttons are not connected properly, the operational safety of the equipment is at risk.

Always mount the internal button, programming button, etc.:

- ◆ outside the reach of movable parts
- ◆ within visibility of the door
- ◆ at a height of at least 1.5 metres



If a wicket door is installed, the door position must be monitored. It must be ensured that the drive is not active if the door is not closed.

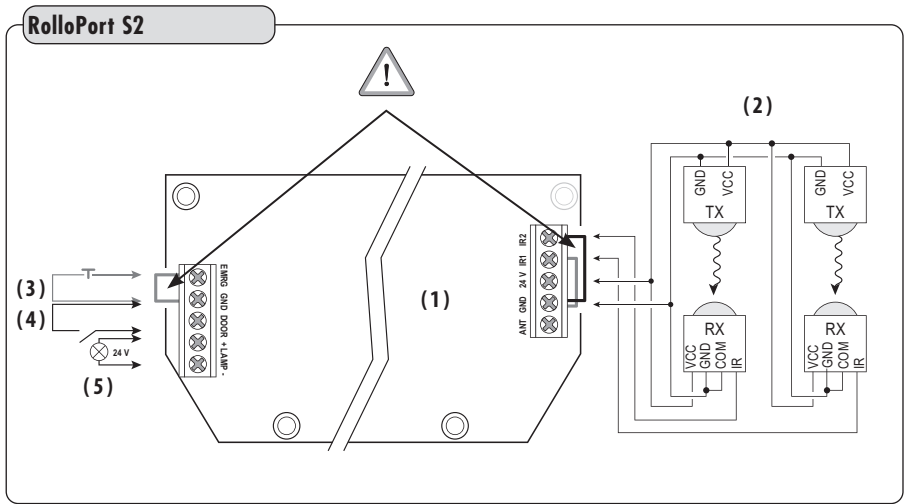

Key

- (1) = main board
- (2) = infrared light barrier (optional)
- (3) = pass door contact
- (4) = external switch (optional)
- (5) = Signal lamp (24 V)

* The signal lamp flashes as long as the drive moves. It is not a permanent light.



NOTE!

Remove the respective factory installed bridge before connecting a light barrier or a pass door contact.

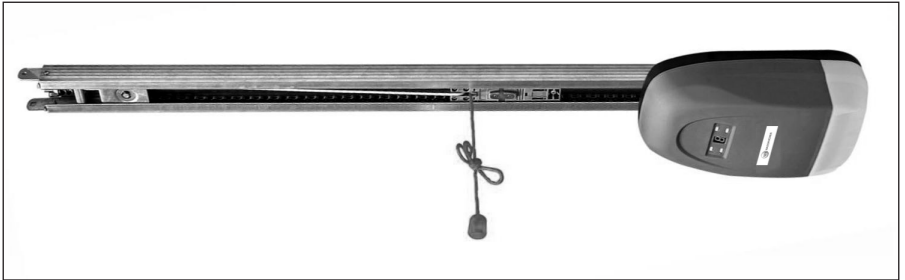

In the case of power failure:

- 1. If you wish to manually operate the door in the event of a power cut, you must pull the emergency release cable so that this releases the door from the door operator.**

After that you can move the door freely.



There is a risk of injury. The door can fall down uncontrollably when released (e.g. if the door is not balanced)

- ◆ Close or open the door fully after each release.
- ◆ The emergency release is not intended for „everyday use“.

If power recovers:

- 1. Operate the hand transmitter or the wall switch.**

NOTE

Engagement happens automatically.

Notes for use

- ◆ Check the operator system to determine whether it moves smoothly the first time the garage door operator is used.
- ◆ After some time in use, check regularly to see whether the door remains horizontal when opening and closing and whether the spring has enough power to lift the door. Lubricate all movable parts regularly with a suitable lubricant.
- ◆ In the event of a power cut, you can pull the emergency release and freely move the door manually.

When the power is back, you can operate the hand transmitter or the wall panel, and the emergency release will engage automatically.

The door can then be operated again with the hand transmitter or the wall panel.

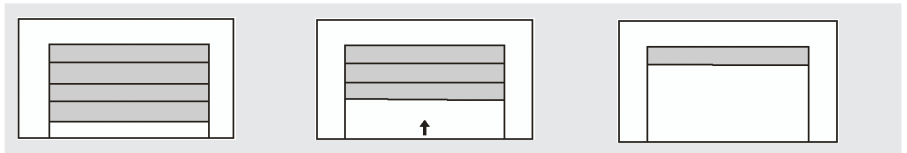

1. In the event of a power cut, the door stops moving.
2. Once the power is back on, press a button on the hand transmitter, and the door will open.
3. According to the program memory, the door will open as far as the upper limit and then stop.

Normal operation**◆ Remote control**

By pressing the previously set button on the hand transmitter, the door can be opened, closed or stopped.

◆ Manual operation

In the event of a power cut, the door can be opened or closed manually as soon as the door operator has been disengaged (refer to page 30).

Model and recommended use

Item no.	Voltage (V)	Door size (m ²)	Admissible ambient temperature (°C)
4201 70 61 4202 70 61	220 – 240	≤ 10	–20...+40

Guide rail and available sizes

Item no.	max. total length	Height of travel	max. lifting height
4201 70 61	3140 mm	2310 mm	2250 mm
4202 70 61	3740 mm	2910 mm	2850 mm

Technical Data

Output:	100 W
Standby mode:	< 1 W
Tractive force:	700 N
Supply voltage:	230 V / 50 Hz
Motor:	24 V (DC) direct current
Light:	Power LED with timeout
Door operating speed:	11 cm/second
Transmission frequency and range:	433 MHz/open terrain 50 m
Drive:	chain
Method of protection:	Use only in dry rooms
Noise pressure level (LpA):	≤ 70 dB(A)

Permitted garage door dimensions

Permitted door leaf surface:	max. 4.1 m x 2.56 m, 10.5 m ² (for sectional doors); max. 3.25 m x 2.26 m, 7.345 m ² (for one-piece doors)
Maximum infill weight for up-and-over doors:	114 kg (for sectional doors); 76.65 kg (for one-piece doors)

Error	Causes	Solution
The door operator does not work.	<ol style="list-style-type: none">1. The plug is not inserted properly.2. The fuse has been tripped.	<ol style="list-style-type: none">1. Plug the mains plug into the mains outlet.2. Have the cause checked by a qualified person, then switch the fuse back on again.
The hand transmitter cannot actuate the door operator.	<ol style="list-style-type: none">1. The hand transmitter may have been wrongly registered or has not been registered at all.2. The battery is out of power.	<ol style="list-style-type: none">1. Register the hand transmitter again, refer to page 28.2. Replace the battery
The operating range of the hand transmitter is too restricted.	The battery may be empty.	Replace with a new one of the same model.
The chain moves, but the door does not.	The emergency release may have been triggered.	Operate the door operator until the emergency release engages again automatically.
When operating, a grating sound can be heard.	There is not sufficient lubricant between the rail and the chain slide after long use.	Insert a suitable lubricant in the position between the rail and the chain slide.
The chain has some sag and is noisy.	The chain is loose due to long use without lubricant between the rail and the chain slide.	Tension the chain as described on page 15 and apply a suitable lubricant to the chain.

CE RADEMACHER Geräte-Elektronik GmbH hereby declares that the RolloPort S2 complies with the Directives **2006/42/EC (Machinery directive)** and **2014/53/EU (Radio Equipment Directive)**.

The full text of the EU declaration of conformity is included with the product and is kept on file by the manufacturer.

RADEMACHER Geräte-Elektronik GmbH

Buschkamp 7

46414 Rhede (Germany)

Warranty terms and conditions

You can find information about the warranty conditions of our products on our homepage.

RADEMACHER
Geräte-Elektronik GmbH
Buschkamp 7
46414 Rhede (Germany)