

The Genuine. The Original.



## Destiny™ 1200

### Model 8030/8030H

#### Chain and Belt Openers

- CodeDodger® remote for the ultimate in safety
- Safe-T-Beam® system must be installed to close door
- Homelink® and Car2U® compatible
- 2-bulb light system
- Motion detection feature activates lights
- Wall console
- Easy programming

#### For answers and assistance

**1.800.929.3667**

or visit

**www.OverheadDoor.com**

**WARNING:** To reduce the risk of injury to persons or damage to property - Use this opener only with a one piece or sectional door.



Installer: Leave this manual with homeowner.

# Operation and Maintenance Manual

Save this manual for future reference.

# SAFETY INFORMATION

## OVERVIEW OF POTENTIAL HAZARDS READ THIS SAFETY INFORMATION

### CONVENTIONS USED IN THESE INSTRUCTIONS

Garage doors are large, heavy objects that move with the help of springs under high tension and electric motors. Since moving objects, springs under tension, and electric motors can cause injuries, your safety and the safety of others depend on you reading the information in this manual. If you have questions or do not understand the information presented, call your nearest trained door system technician or visit our website.

The following Safety Alert symbol and signal words are used throughout this manual to call attention to and identify different levels of hazard and special instructions.



This is the safety alert symbol. This symbol alerts you to potential hazards that can kill or hurt you and others. All safety messages will follow the safety alert symbol and the word "**DANGER**", "**WARNING**", or "**CAUTION**"



**DANGER** indicates an imminently hazardous situation which, if NOT avoided, will result in death or serious injury.

**WARNING** indicates a potentially hazardous situation which, if NOT avoided, could result in death or serious injury.

**CAUTION** indicates a potentially hazardous situation which, if NOT avoided, may result in injury or property damage.

The word **NOTE** is used to indicate important steps to be followed or important considerations.

## IMPORTANT SAFETY INSTRUCTIONS READ AND FOLLOW ALL INSTRUCTIONS SAVE THESE INSTRUCTIONS

Potential Hazard	Effect	Prevention
	<p><b>WARNING</b></p> <p>Could result in Death or Serious Injury</p>	<p>Keep people clear of opening while Door is moving.</p> <p>Do <b>NOT</b> allow children to play with the Door Opener.</p> <p>Do <b>NOT</b> operate a Door that jams or one that has a broken spring.</p>
	<p><b>WARNING</b></p> <p>Could result in Death or Serious Injury</p>	<p>Turn <b>OFF</b> power before removing opener cover.</p> <p>When replacing cover, make sure wires are NOT pinched or near moving parts.</p> <p>Opener must be fully grounded.</p>
	<p><b>WARNING</b></p> <p>Could result in Death or Serious Injury</p>	<p>Do <b>NOT</b> try to remove, install, repair or adjust springs or anything to which door spring parts are fastened, such as, wood blocks, steel brackets, cables or other like items.</p> <p>Installations, repairs and adjustments must be done by a trained door system technician using proper tools and instructions.</p>

## OPENER FEATURES



### **CODEDODGER® 2 Access Security System**

An access code system that enhances the security of the door opener by continuously changing the access code each time the remote is used. The door opener responds to each new code only once. An access code copied from a working system and tried again will not control the door opener.



### **Wall Console, Series III**

Operates door opener from inside garage. The Wall Console has an Indicator Light with: Open/Close, Sure-Lock™, and Independent Light Control buttons.



and **Car2U**® compatible. Refer to the programming instructions on page 10 and then follow the **HomeLink**® or **Car2U**® instructions in your car owner's manual.

## SAFETY FEATURES



### **Safe-T-Beam® (STB) Non-Contact Reversing System**

Puts an invisible beam across the door opening. The door stops and reverses to the full open position if anything passes through the beam. LED indicator lights on the powerhead and on the STBs provide a self diagnostic code if an operational problem exists.

### **Safe-T-Reverse® Contact Reversing System**

Automatically stops and reverses a closing door within two seconds of contact with an object.

### **Automatic ForceGuard™ Control**

Automatically sets the force required to fully open and close the door for maximum safety.

### **Watch Dog™ Monitoring System**

Monitors the Safe-T-Beam® system to ensure proper functionality and will automatically stop and reverse a closing door if a problem is detected.



### **Manual Emergency Release**

Manually releases door from door opener. Used during a power failure or other emergency to allow manual opening and closing of door.



### **SmartSet™ Electronic Programming**

Easily adjust the programming to reduce opening speed to a desired rate, optionally adjust limits and force, and program new remotes.



### **Automatic Lighting System**

Two bulb lighting system supplies up to 200 Watts of light for safer evening exits and entries. Turns **ON** when door is activated and automatically turns **OFF** 4 minutes later.



### **Integrated Motion Detection** (Not available on all models)

Select units have motion detection built into the powerhead. Lights automatically turn **ON** when motion is detected for much safer movement through the garage. Lights will turn **OFF** after 4 minutes of no motion.

# TABLE OF CONTENTS

Section .....	Page
<b>Safety Information</b> .....	2
<b>Opener Features &amp; Safety Features</b> .....	3
<b>Table of Contents</b> .....	4
 <b>Installation</b>	
<b>Important Installation Instructions</b> .....	5
<b>1 Programming Limits &amp; Force</b> .....	6-7
<i>Contact Reverse Test</i> .....	9
<b>2 Program CodeDodger® 2 Remote to Powerhead</b> .....	9
<i>Programming HomeLink®, Car2U®, CodeDodger® 1 remotes or wireless keypads</i> .....	10
 <b>Reference</b>	
<b>3 Typical Installed Illustrations</b> .....	11-13
<i>Powerhead &amp; Rail Assembled View</i> .....	11
<i>Typical Sectional Door Installation</i> .....	12
<i>Typical One Piece Door Installation</i> .....	13
<b>4 Overview of Powerhead Controls</b> .....	14
<b>5 Overview of Remotes and Options</b> .....	15-16
<i>Lost or Stolen Remote - Clearing Memory</i> .....	15
<i>CodeDodger® Features</i> .....	16
<i>Previously Installed Openers</i> .....	16
<b>6 Maintenance &amp; Troubleshooting</b> .....	17-26
<i>Important Safety Instructions</i> .....	17
<i>Routine Monthly Maintenance</i> .....	18
<i>Door Balance (Spring Tension)</i> .....	18
<i>Safe-T-Beam® System Check</i> .....	18
<i>Contact Reverse Test</i> .....	18
<i>Change Light Bulbs</i> .....	19
<i>Motion Detector - Overview</i> .....	19
<i>Reset - Open/Close Travel Limit</i> .....	19
<i>Carriage Engage/Disengage</i> .....	19
<i>Wall Console</i> .....	20
<i>Optional Dual Wall Console - Installation</i> .....	20
<i>Chain or Belt Tension Adjustment</i> .....	21
<i>Remote Battery Replacement</i> .....	21
<i>Speed Adjustment Guide</i> .....	22
<i>Force Adjustment Guide</i> .....	23
<i>Troubleshooting Guide - Operation</i> .....	24-25
<i>Troubleshooting Guide - Powerhead LEDs</i> .....	25
<i>Reference - Wiring Diagram</i> .....	26
<b>Warranty</b> .....	27

OPENER MUST BE INSTALLED WITH THE INCLUDED WALL CONSOLE.

**Safe-T-Beam®** SAFETY REVERSE SYSTEM MUST BE INSTALLED TO CLOSE DOOR.

# Begin here after the opener's physical assembly and installation has been completed.

There are no assembly or installation steps included in this manual. Contact your Ribbon Distributor for an installation poster, if required.

The following mechanical assembly tasks must be completed before continuing.

- Powerhead and rail are bolted to each other (An illustration is shown on page 11)  
*Example illustrations of the following items are shown on pages 12 and 13*
- Rail end is attached to a header bracket which is attached to the garage door header
- Powerhead is attached to a support frame suspended from the ceiling or ceiling joists
- Both pieces of door arms are assembled and are attached to the garage door
- Safe-T-Beam® sensors installed and wired
- Wall console installed and wired (*Shown on page 20*)
- Carriage is engaged to the chain or belt drive (*An illustration is shown on page 11*)
- Powerhead is plugged into an approved power outlet

## Begin programming by setting Limits (see next page.)

A PDF VERSION INSTALLATION POSTER IS AVAILABLE AT [WWW.OVERHEADDOOR.COM](http://WWW.OVERHEADDOOR.COM)

## IMPORTANT INSTALLATION INSTRUCTIONS

### **⚠ WARNING: To reduce the risk of severe injury or death:**

1. **READ AND FOLLOW ALL SAFETY, INSTALLATION AND OPERATION INSTRUCTIONS.** (If you have questions or do not understand an instruction, call the Overhead Door Corporation.)
2. Install only on a properly balanced **sectional** or **one piece** garage door. An improperly balanced door could cause severe injury. Have a trained door system technician make repairs or adjustments to cables, spring assemblies, and other hardware **before** installing the opener.
3. Remove all ropes and remove or make inoperative all locks connected to the garage door before installing opener.
4. Where possible, install the door opener **7 feet or more above** the floor. For products having an emergency release, mount the emergency release 6 feet above the floor.
5. **Do NOT** connect the opener to source of power until instructed to do so.
6. Locate the wall console:
  - Within sight of the garage door,
  - At minimum height of 5 feet so small children are not able to reach it, and
  - Away from all moving parts of the door.
7. Install the **Entrapment WARNING Label** next to the wall console in a prominent location.
8. After installing the opener, the door must reverse within 2 seconds when it contacts a 1-1/2 inch high object (or a 2 x 4 board laid flat) on the floor.

### INFRARED PROTECTION FUNCTION

1. When garage door is opening, its movement will not be influenced if the Safe-T-Beam® is obstructed.
2. If the Safe-T-Beam® is obstructed before the garage door fully closes, the door will not close.
3. When the garage door is closing, if Safe-T-Beam® is interrupted by person or obstacle, the garage door will stop its downward travel and reverse automatically to its fully opened position.
4. Remove Safe-T-Beam® obstruction.
5. If the Safe-T-Beam® System fails, loses power, or is installed improperly, press and hold the wall console "open/close" button until the door reaches its fully closed position. If you release the "open/close" button on the wall console during the closing movement the door will reverse automatically to its fully opened position.

# 1 PROGRAMMING LIMITS & FORCE

(Continuing from Installation Poster if provided)



## SETTING & TESTING LIMITS AND FORCE

The OPEN (UP) and CLOSE (DOWN) **Door Limit positions** are controlled by making adjustments using the panel located on the bottom of the powerhead. Begin with Step 1 and continue through Step 10. **Door Force** is set during the final Open/Close cycle of these steps. The powerhead will automatically set door speed at slow if the distance between limits is less than 6 feet. Once Limits and Force are set **DO NOT** use the  $\nabla$  or  $\triangleright$  buttons to open or close door.

### A) CLOSE DOOR TRAVEL LIMIT

**NOTE: If bullet has NOT been engaged to the carriage, do so now.**

Please note that there is a 30 second timeout **between each** programming step. A programming timeout during these steps has occurred when **two RED flashing LEDs** appear. In the event of a timeout please restart at Step 1.

4

**NOTE:** if one or both LEDs come ON RED at this time, Limits programming menu was not entered properly. You must exit programming and restart. To exit the programming function wait **30 seconds** for the programming to time out.

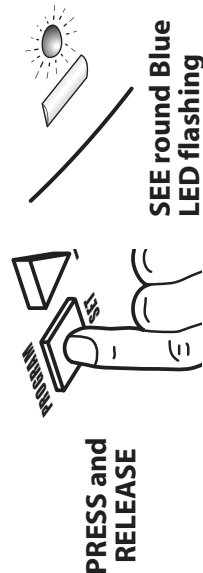

1

**PRESS and HOLD**

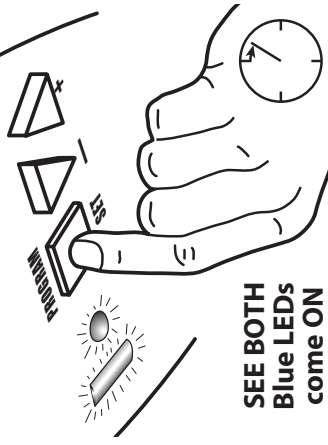

SEE BOTH Blue LEDs come ON

2

**RELEASE**



SEE round Blue LED come ON

3

**PRESS and RELEASE**

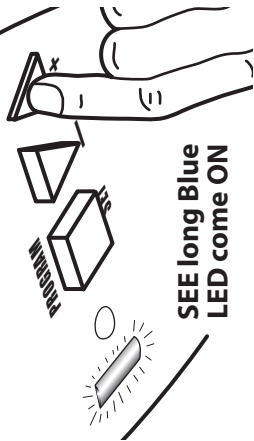

SEE long Blue LED come ON

If RED LED comes ON - STOP and exit programming

5

**PRESS and HOLD until door is FULLY CLOSED then RELEASE**



Watch door move

**NOTE:** You can start and stop door movement using either  $\nabla$   $\triangleright$  buttons until door is in correct open or closed position.

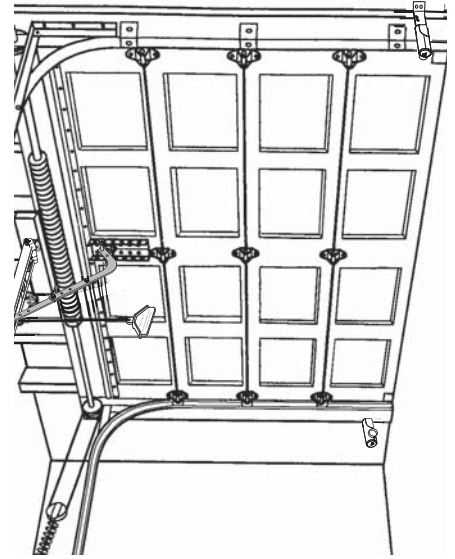

## WARNING

- Make sure doorway is in view and clear of obstacles and people to avoid injury or damage to property.
- **DO NOT** operate this unit from wall console before LIMITS and FORCE are set. Severe damage to the opener can occur.
- Bullet **MUST** be engaged to carriage **BEFORE** setting limits. See Installation Poster (if provided) or refer to pages 11 and 19.

## B) OPEN DOOR TRAVEL LIMIT

7

PRESS and HOLD until door is FULLY OPEN then RELEASE

6  
PRESS and  
RELEASE

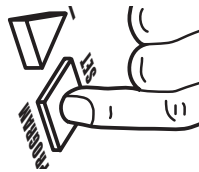

8  
PRESS and  
RELEASE

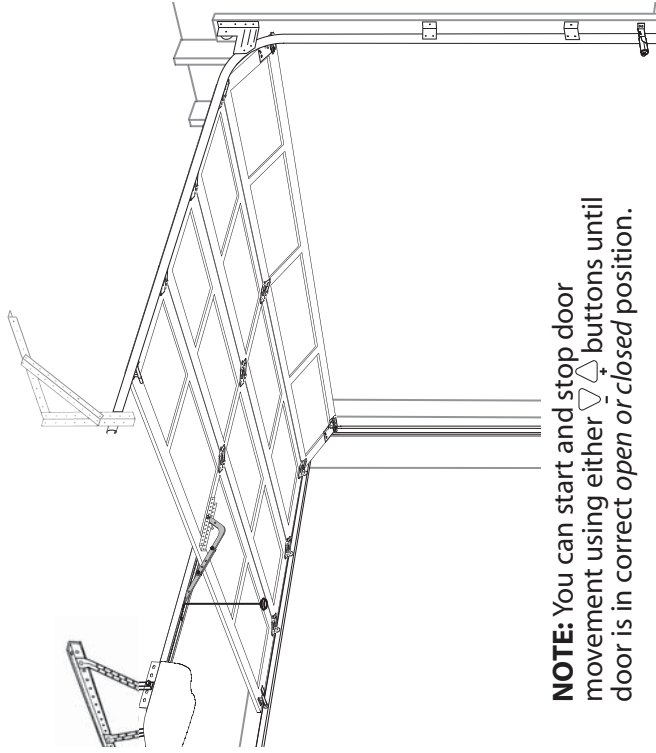
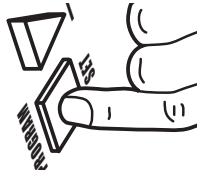

Watch door move

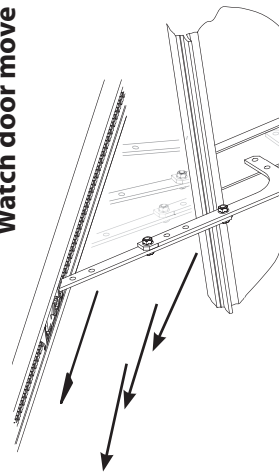

SEE long Blue LED  
flashing



Door Limits are set.  
**Both LEDs flash Blue  
and go OFF.**  
Continue with  
Step 9 SET FORCE.

**NOTE:** You can start and stop door movement using either  $\nabla$   $\triangle$  buttons until door is in correct *open or closed* position.

9

**SET FORCE**

Force is set automatically with first full CLOSE/OPEN door operation.

On Wall Console  
PRESS and RELEASE

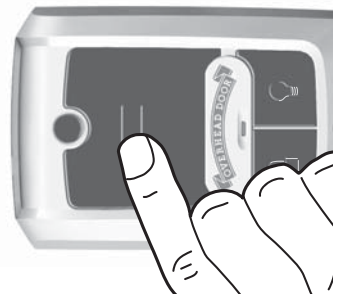

DOOR CLOSES

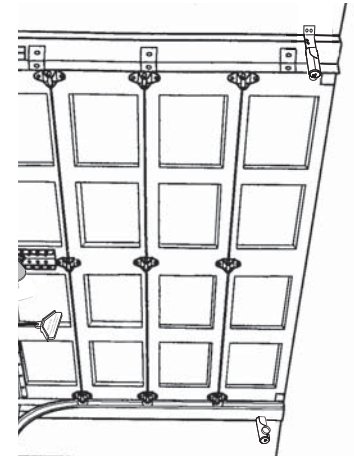

10

On Wall Console  
PRESS and RELEASE

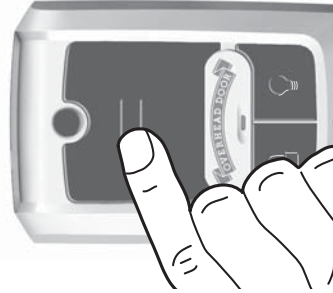

DOOR OPENS

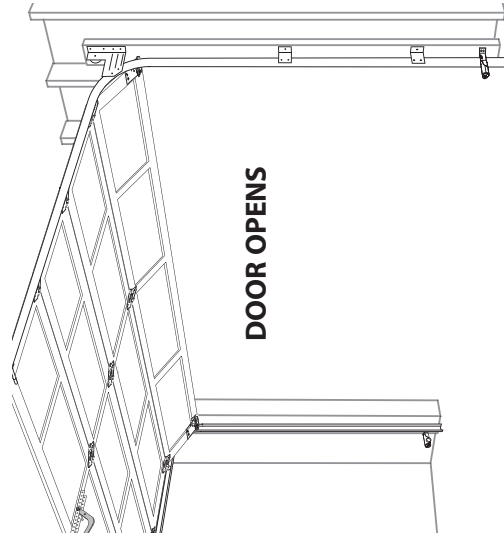

**Perform a successful CONTACT REVERSE TEST and then continue with remote programming.**

**NOTE:** To reset LIMIT settings, repeat Steps 1-10.

## CONTACT REVERSE TEST

The Force and Limit settings on the previous page **MUST** be COMPLETED before Contact Reverse testing.

### 1. Test.

- Open garage door using wall console.
  - Place a 2" x 4" board (laid flat) under center of garage door opening.
- Close garage door using wall console.
- When door contacts board, the door must stop (within 2 seconds) and reverse direction returning to open position.

### 2. Adjustment.

- If the door:
  - Stops before it contacts the 2 x 4 board, it may simply be responding to an improperly set down limit. Return to pages 6-7 and repeat steps 1 through 10 to correct down limit.
  - Stops after contacting the 2 x 4 board and does not reverse it may need an adjustment to the down limit. Return to pages 6-7 and repeat steps 1 through 10 to correct down limit.
- Test again. Repeat as necessary until door reverses upon contacting board.

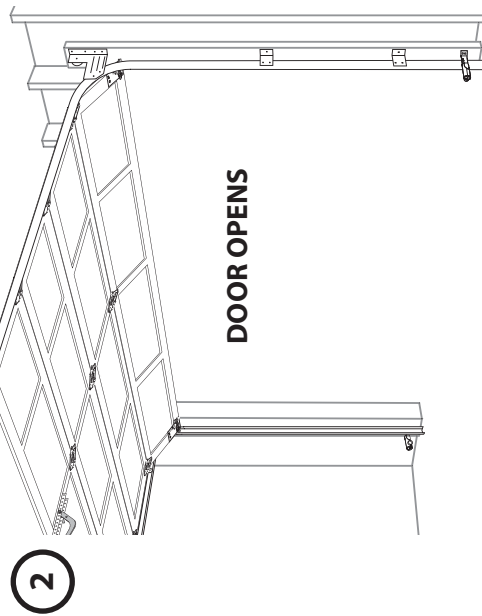

2

PRESS and RELEASE

3

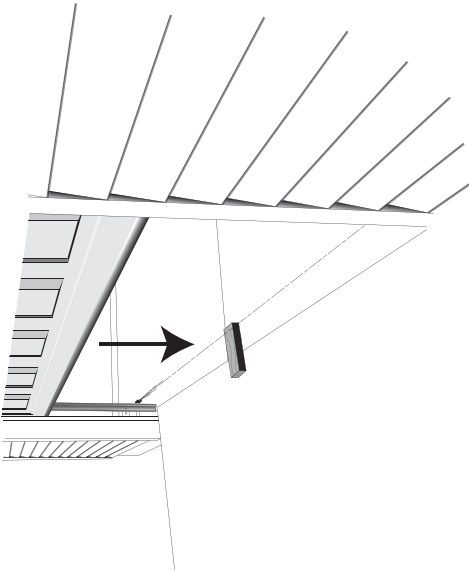
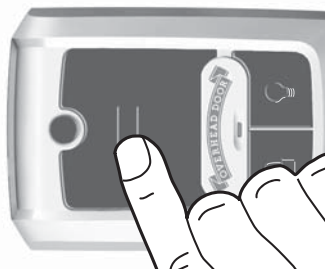

4

## WARNING

**A moving door can cause serious injury or death.**

1. Keep people clear of opening while door is moving.
2. Do **NOT** allow children to play with opener, including wall console, remote, or wireless keypad.
3. During programming, door opener could begin to run, so stay away from moving door and its parts.

On Wall Console  
PRESS and RELEASE

1

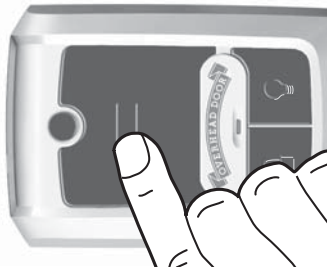



## 2 PROGRAM CODEDODGER® 2 REMOTE TO POWERHEAD

FOR HELP-1.800.929.3667 OR WWW.OVERHEADDOOR.COM

Bring remote(s) to powerhead location.

Begin with Step 1 and continue through Step 7 for each button to be programmed.

**NOTE:** The following instructions are for the remote(s) provided with this opener. This remote is preset for use with the **CodeDodger® 2** Access Security System. Refer to page 16 for additional information on **CodeDodger® 1** and **2** remotes and how to switch from **CodeDodger® 2** to **CodeDodger® 1**. See page 10 for programming instructions using **CodeDodger® 1** remotes.

### WARNING

**A moving door can cause serious injury or death.**

1. Keep people clear of opening while door is moving.
2. Do **NOT** allow children to play with opener, including wall console, remote, or wireless keypad.
3. During programming, door opener could begin to run, so stay away from moving door and its parts.

1

**PRESS and HOLD**

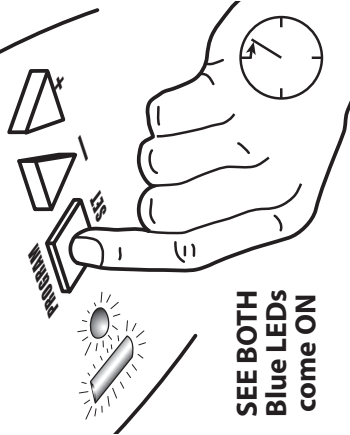

**SEE BOTH Blue LEDs come ON**

2

**RELEASE**



**SEE round Blue LED come ON**

3

**PRESS and RELEASE**

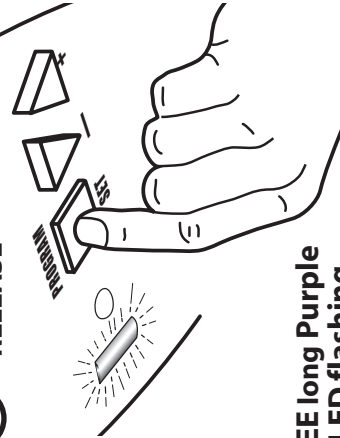

**SEE long Purple LED flashing**

4

**PRESS and RELEASE**

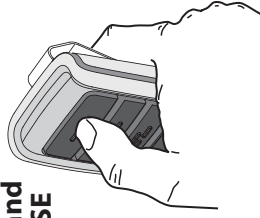

**SEE both LEDs flash Purple**

5

**PRESS and RELEASE**

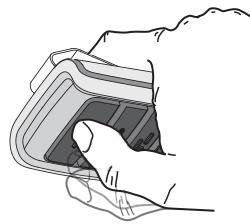

**SEE both LEDs flash Blue**

6

**SEE both LEDs OFF**



7

**PRESS and RELEASE**

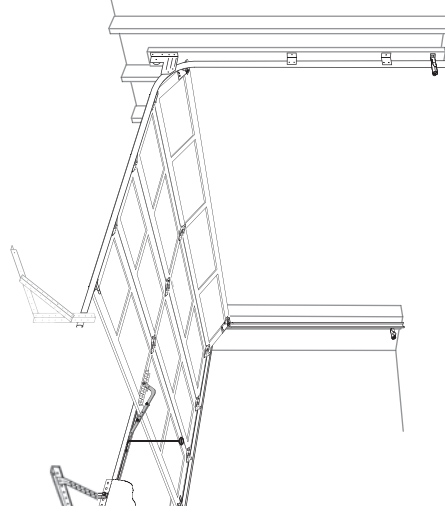
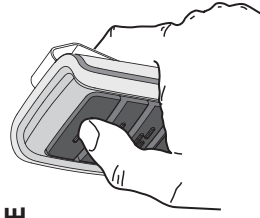

The next press of the remote will operate door.  
Repeat as necessary for other remotes.

**Basic powerhead programming is complete.  
Your garage door opener is ready to use.**

## OPTIONAL PROGRAMMING POWERHEAD TO Homelink®, Car2U®, or CodeDodger® 1 REMOTES and CodeDodger® 1 WIRELESS KEYPADS

To complete any of these tasks you **MUST** have at least one **CodeDodger® 2** remote button already programmed to the powerhead present.

**For Homelink® or Car2U®:** You must also have your **Homelink®** or **Car2U®** enabled vehicle present and their programming instructions to perform these programming steps.

**For Overhead Door CodeDodger® 1 remote:** You must also have your Overhead Door **CodeDodger® 1** remote present.

**For Overhead Door CodeDodger® 1 wireless keypad:** You must also have your Overhead Door wireless keypad installed and a PIN already programmed into the keypad. Programming instructions for **Overhead Door CodeDodger® 2 wireless keypad** will come with the wireless keypad.

**1** PRESS and HOLD

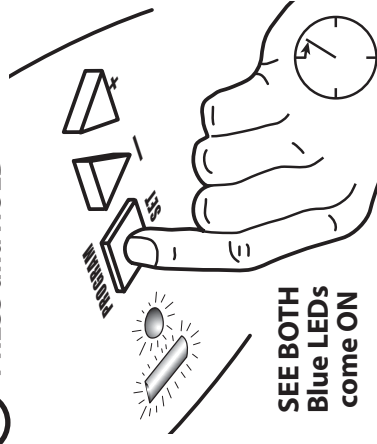

SEE BOTH Blue LEDs come ON

**2** RELEASE

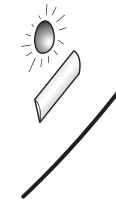

SEE one Blue LED come ON

**3** PRESS and RELEASE

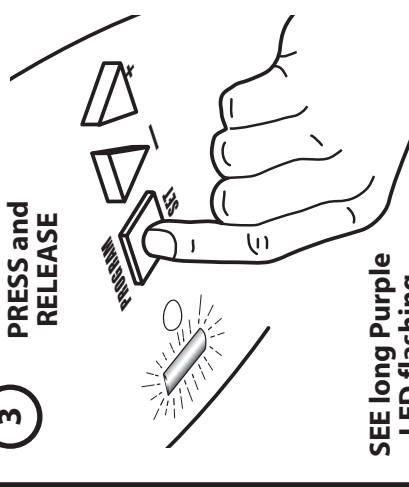

SEE long Purple LED flashing

**4**

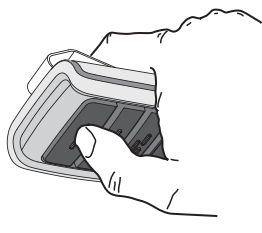

SEE both LEDs flash Purple

**PRESS and release** a previously programmed **CodeDodger® 2** button on remote. If you are unsure which remote you have see page 16. Remote must be **CodeDodger® 2** enabled.





## Homelink® or Car2U® programming

- 5** PRESS the **Homelink®** button **twice**.
- 6** Test. Repeat as necessary for any other *pre-programmed Homelink®* enabled vehicle.
- 5** For **Car2U®** enabled vehicles follow the **Car2U®** instructions.
- 6** Test. Repeat as necessary for any other **Car2U®** enabled vehicle.

## CodeDodger® 1 remote or wireless keypad programming

- 5** On the **CodeDodger® 1** remote PRESS a button and RELEASE. SEE long LED come ON **Purple**.
- 6** On the **CodeDodger® 1** remote PRESS the same button and RELEASE. SEE both LEDs on the **powerhead** come ON **Blue**. The next press of the remote will operate door.
- 7** Test. Repeat as necessary for any other **CodeDodger® 1** remotes.

## CodeDodger® 1 wireless keypad

- 5** Enter your **wireless keypad** PIN.
- 6** Press and hold  button 1 second then release and see **on powerhead** long LED come ON **Purple**.
- 7** Press and hold  button 1 second again then release and see **on powerhead** long LED come ON **Blue**.
- 8** Press and hold  button again and opener will activate
- 9** Wait 30 seconds, enter pin and press  button to verify operation.

**Homelink® programming**  
If your **Homelink®** has been previously programmed to an Overhead Door opener begin with Step 1 and continue through Step 5 and 6 of the **Homelink®** section below.

If your **Homelink®** has **not** yet been linked to an Overhead Door opener then go to page 16 and change one remote button from **CodeDodger® 2** to **CodeDodger® 1**, then program that button with the car **Homelink®** using **Homelink®** instructions and begin with Step 1 and continue through Step 5 and 6 of the **Homelink®** section below.

**All optional programming is complete. Your garage door opener is ready to use.**

**REFERENCE - POWERHEAD & RAIL ASSEMBLED VIEW**  
**RÉFÉRENCE - VUE DE LA TÊTE D'ALIMENTATION & DU RAIL ASSEMBLÉ**  
**REFERENCIA - VISTA DEL CABEZAL ELÉCTRICO Y RIEL ENSAMBLADOS**

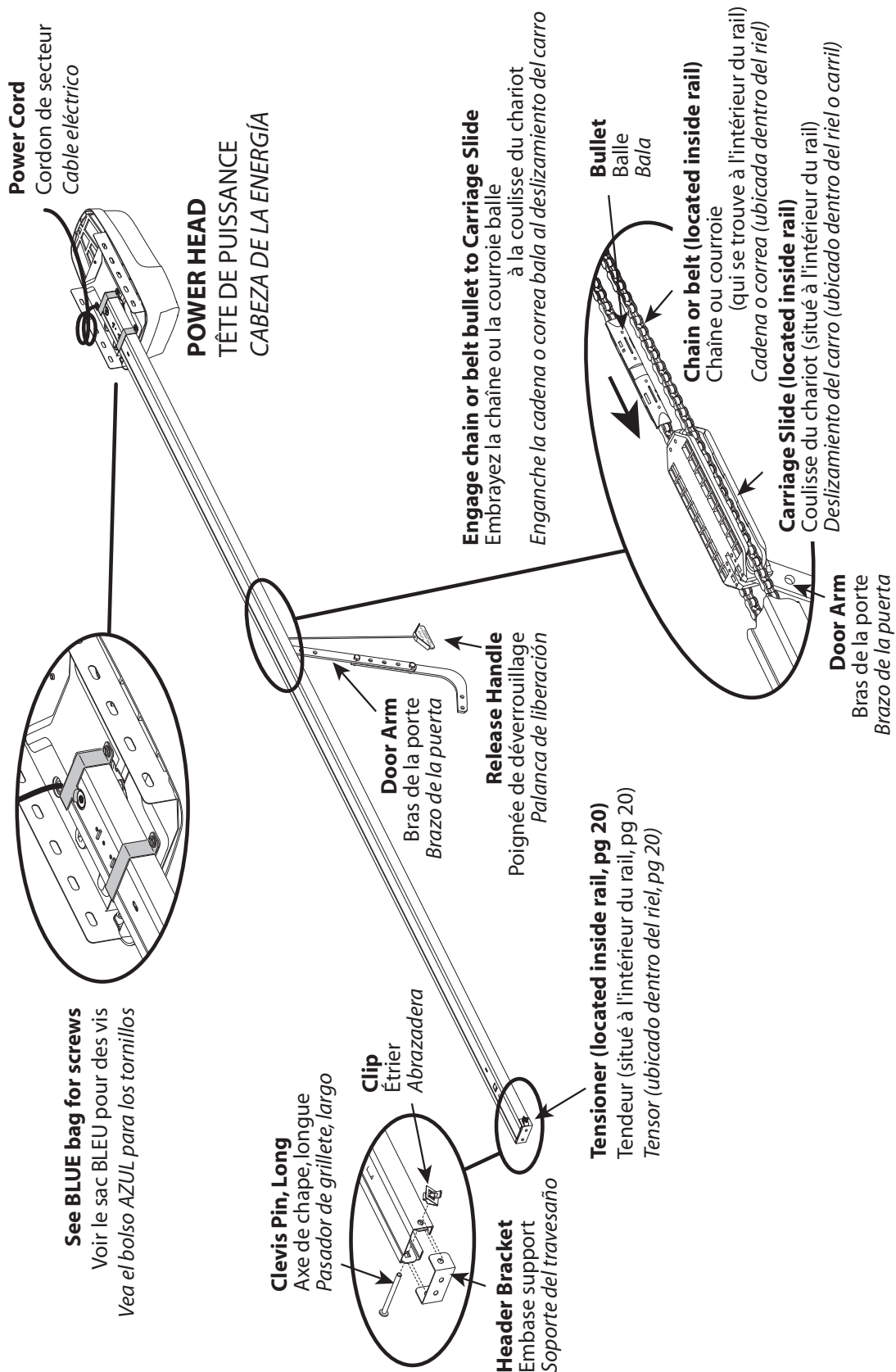

**FIG. 3-3**

**NOTE: Use wall console and safety sensors provided with this unit. Do NOT substitute wall console or safety sensors.**  
 REMARQUE: Utilisez la console sur le mur et les capteurs de sécurité fournis avec cet appareil. NE PAS substituer la console du mur ou les capteurs de sécurité.  
 NOTA: Use la consola de pared y los sensores de seguridad proporcionados con esta unidad. NO sustituya la consola de pared ni los sensores de seguridad.

# 3 TYPICAL SECTIONAL DOOR INSTALLATION FOR HELP-1.800.929.3667 OR WWW.OVERHEADDOOR.COM

INSTALLATION TYPIQUE SUR UNE PORTE SECTIONELLE ..... POUR OBTENIR DE L'AIDE-1.800.929.3667

INSTALACIÓN HABITUAL DE UNA PUERTA SECCIONAL ..... PARA OBTENER AYUDA, LLAME AL 1.800.929.3667

**\*If required direct wiring of power supply to opener must be installed by a licensed electrician. Power cord must reach grounded outlet without use of extension cord.**

**\*\*Le câblage direct de l'alimentation d'énergie à l'ouvreuse doit être installé s'il y a lieu par un électricien autorisé. Le cordon de secteur doit atteindre la sortie au sol sans utilisation de corde de prolongation.**

**\*\*\*Si procede el cableado directo de la fuente de alimentación al abre puertas se debe instalar por un electricista autorizado. El cable eléctrico debe alcanzar el enchufe puesto a tierra sin el uso de la cuerda de extensión.**

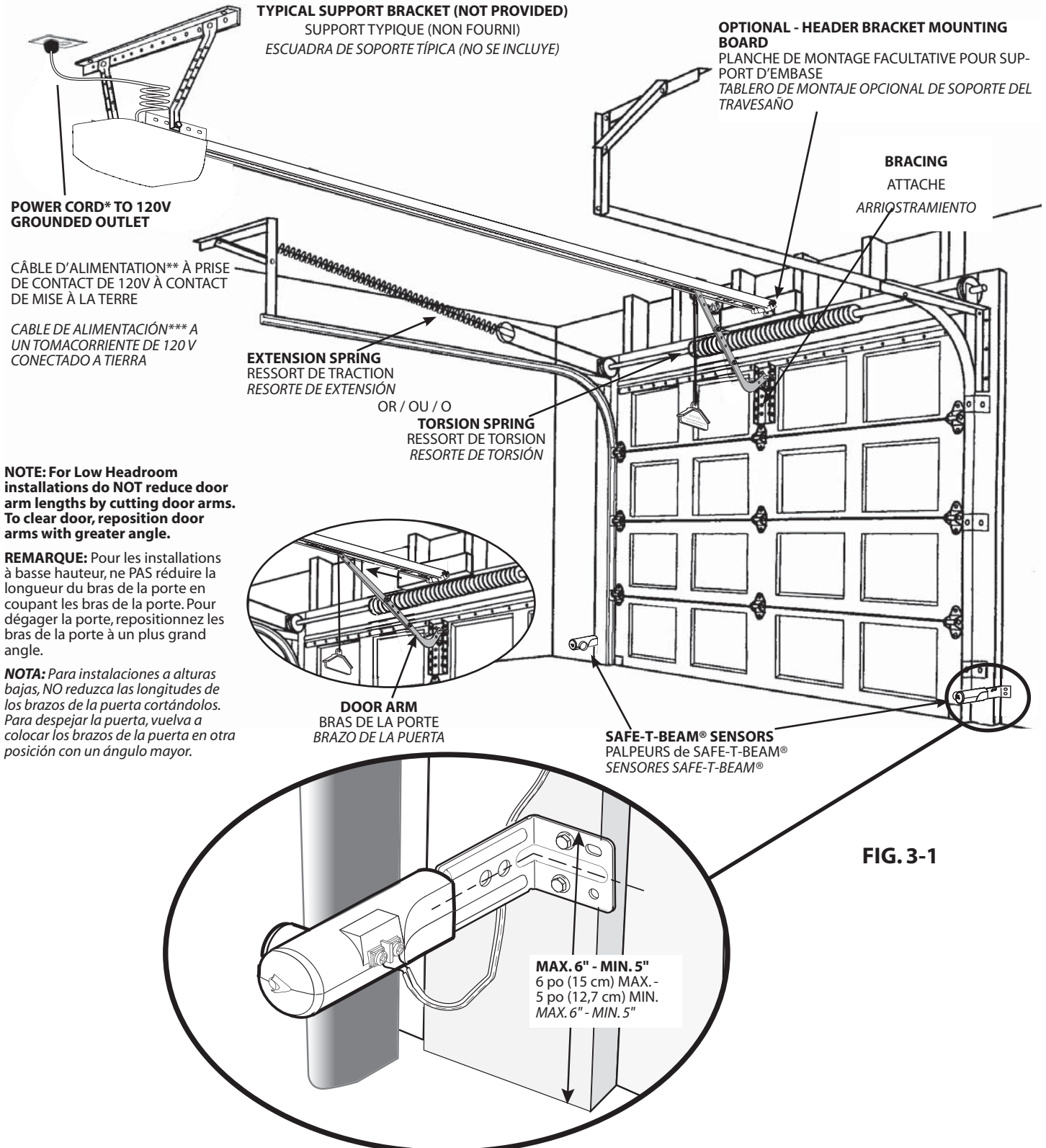

**NOTE: For Low Headroom installations do NOT reduce door arm lengths by cutting door arms. To clear door, reposition door arms with greater angle.**

**REMARQUE:** Pour les installations à basse hauteur, ne PAS réduire la longueur du bras de la porte en coupant les bras de la porte. Pour dégager la porte, repositionnez les bras de la porte à un plus grand angle.

**NOTA:** Para instalaciones a alturas bajas, NO reduzca las longitudes de los brazos de la puerta cortándolos. Para despejar la puerta, vuelva a colocar los brazos de la puerta en otra posición con un ángulo mayor.

**TYPICAL ONE PIECE DOOR INSTALLATION** ..... FOR HELP-1.800.929.3667 OR WWW.OVERHEADDOOR.COM  
**INSTALLATION TYPIQUE D'UNE PORTE DE GARAGE D'UNE PIÈCE** ..... POUR OBTENIR DE L'AIDE-1.800.929.3667  
**INSTALACIÓN HABITUAL DE PUERTA DE UNA SOLA PIEZA**..... PARA OBTENER AYUDA, LLAME AL 1.800.929.3667

**\*If required direct wiring of power supply to opener must be installed by a licensed electrician. Power cord must reach grounded outlet without use of extension cord.**

**\*\*Le câblage direct de l'alimentation d'énergie à l'ouvreur doit être installé s'il y a lieu par un électricien autorisé. Le cordon de secteur doit atteindre la sortie au sol sans utilisation de corde de prolongation.**

**\*\*\*Si procede el cableado directo de la fuente de alimentación al abre puertas se debe instalar por un electricista autorizado. El cable eléctrico debe alcanzar el enchufe puesto a tierra sin el uso de la cuerda de extensión.**

**TYPICAL SUPPORT BRACKET (NOT PROVIDED)**

SUPPORT TYPIQUE (NON FOURNI)

ESCUADRA DE SOPORTE TÍPICA (NO SE INCLUYE)

**HEADER BRACKET MOUNTING BOARD (not provided)**

PLANCHE DE MONTAGE FACULTATIVE POUR SUPPORT D'EMBASE (non fourni)

TABLERO DE MONTAJE DE SOPORTE DEL TRAVESAÑO (no proporcionado)

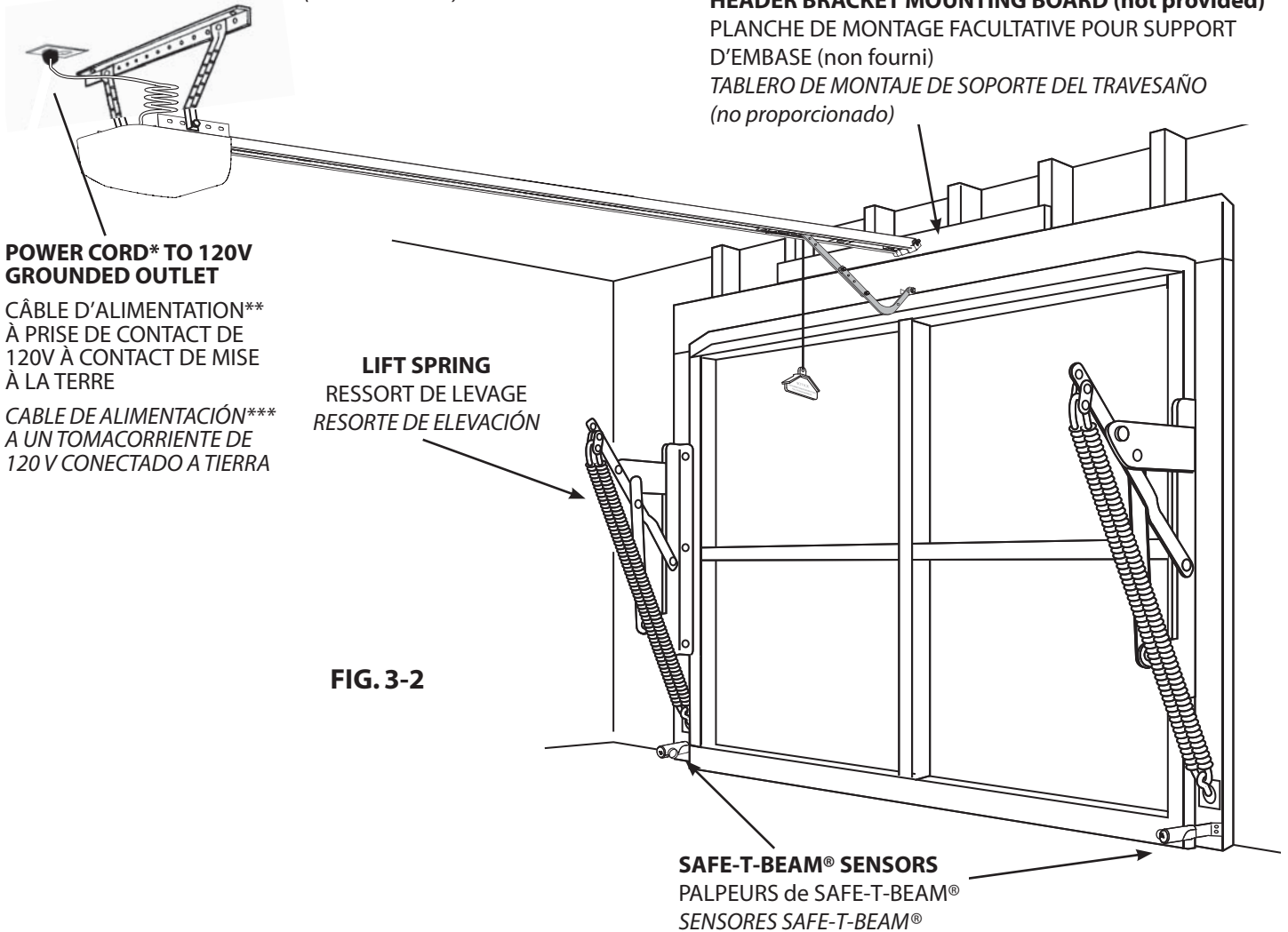
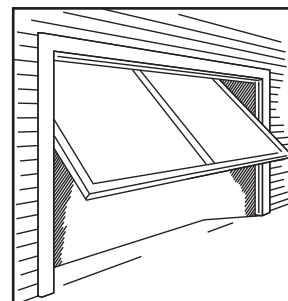

FIG. 3-2

**⚠ WARNING**  
**To reduce the risk of injury to persons or damage to property - Use this opener only with a one piece or sectional door.**

**⚠ AVERTISSEMENT**  
*Pour ramener le risque de dommages aux personnes ou de dommages matériels - utilisez cet ouvreur seulement avec une porte d'une seule pièce ou sectionnelle.*

**⚠ ADVERTENCIA**  
*Para reducir el riesgo de lesión a las personas o de daño a los bienes - utilice este abre puertas solamente con una puerta de una pieza o seccional.*



**ONE PIECE DOOR**  
 PORTE D'UNE PIÈCE  
 PUERTA DE UNA SOLA PIEZA

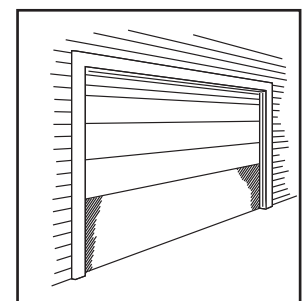

**SECTIONAL DOOR**  
 PORTE SECTIONELLE  
 PUERTA SECCIONAL

## 4 OVERVIEW OF POWERHEAD CONTROLS

This section describes the simple programming functions. Use this page to familiarize yourself with the buttons and LED indicators used to program the opener. **NOTE:** These  $\triangle$  and  $\nabla$  buttons are for programming use only. Do **NOT** use these buttons to operate the opener.

### Programming buttons location on powerhead.

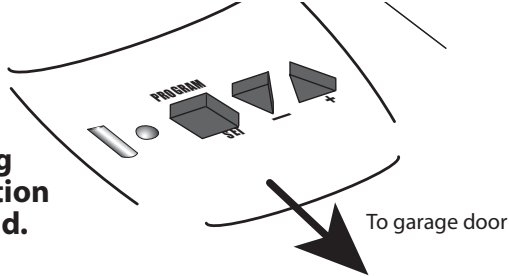

**FIG. 4-1 Locate programming buttons**

There are three programming buttons and two lights (LEDs) on the powerhead.

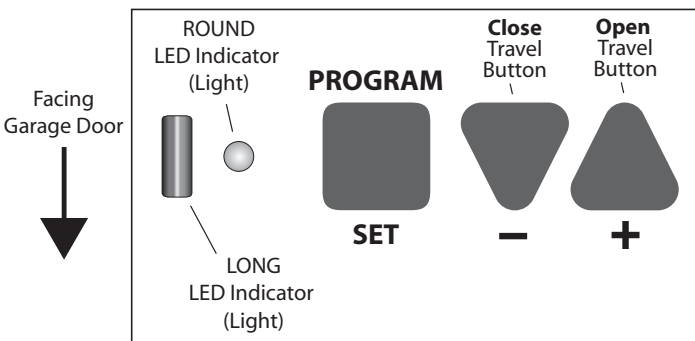

**FIG. 4-2 Programming buttons**

Each of the buttons are used to enter and complete the setup programming. The LEDs indicate status or a function change by illuminating ON, OFF, or ON *flashing* in one of three different colors: BLUE, RED, or PURPLE.

Throughout the instructions in this manual the buttons and LEDs are also displayed as icons.

### Buttons

Name	Shape	Use
Program button		Enters into and selects programming menus
Close Travel button		multi-function; moves door, advances through menus
Open Travel button		multi-function; moves door, advances through menus

### LED Colors

Round Red		and		Long Red
Round Purple		and		Long Purple
Round Blue		and		Long Blue

### Programming Overview

There are four Powerhead program menus:

- Remote Program (Default menu)
- Limits Program
- Speed Program\*
- Force Program\*

Programming steps for Limits and remotes are found on pages 6 through 10.

\*Force and Speed settings are set at the factory and do not normally require adjustment programming. Custom programming instructions for Speed and Force are located in the Troubleshooting Section of this manual.

These are the basic steps to enter into the four programming menus:

1. Press and hold until both BLUE lights come ON then release.
2. Both LEDs go out and Round BLUE light comes ON. You are in the Program Menus at the Remote Programming Menu.  
By using the  $\triangle$  or the  $\nabla$  button you can navigate to the Limits, Speed, or Force program menus and the LED display will change accordingly.  
Each program menu has a specific LED display.

### Press Program LED Display

Default	<b>Remote</b>	Round Blue
	<b>Limits</b>	Long Blue
X2	<b>Speed</b>	Round Blue  &  Long Blue
X3	<b>Force</b>	Round Red

3. Press button to enter into the program menu functions.

If you have entered into an unwanted program menu and are not sure where you are - do not press any buttons for 30 seconds. The programming function will time out after **30 seconds** if there is no key stroke activity.

## 5 OVERVIEW - REMOTES AND OPTIONS

### WARNING

#### A moving door can cause serious injury or death.

1. Keep people clear of opening while door is moving.
2. Do **NOT** allow children to play with opener, including wall console, remote, or wireless keypad.
3. During programming, the door opener could begin to run, so keep people and objects away from the moving door and its parts. To keep the door from moving, close the door and disconnect it from the rail carriage by pulling the Emergency Release Handle. See page 19 for Release Handle operation.

Three Button Remote



FIG. 5-1 Remote

See page 21 for battery changing instructions.



### FCC and IC CERTIFIED

This device complies with FCC Part 15 and RSS 210 of Industry Canada. This equipment has been tested and found to comply with the limits for a Class B digital device, pursuant to Part 15 of the FCC Rules. These limits are designed to provide reasonable protection against harmful interference in a residential installation. This equipment generates, uses and can radiate radio frequency energy and, if not installed and used in accordance with the instructions, may cause harmful interference to radio communications. However, there is no guarantee that interference will not occur in a particular installation. If this equipment does cause harmful interference to radio or television reception, which may be determined by turning the equipment OFF and ON, the user is encouraged to try to correct the interference by one or more of the following measures:

- Re-orient or relocate the receiver antenna.
- Increase the separation between the opener and receiver.
- Connect the opener into an outlet on a circuit different from that to which the receiver is connected.
- Consult your local dealer.

### LOST OR STOLEN REMOTE - CLEARING MEMORY

Clearing remotes from powerhead memory will clear ALL programmed remotes and wireless keypad.

**NOTE:** Follow the PROGRAM REMOTE TO POWERHEAD steps to re-enter remaining or new remotes. See page 9.

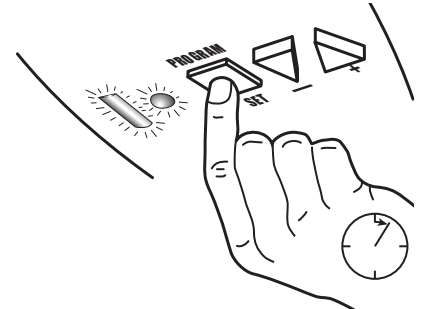

1. Press  and hold until both lights come ON **blue**. Release button.

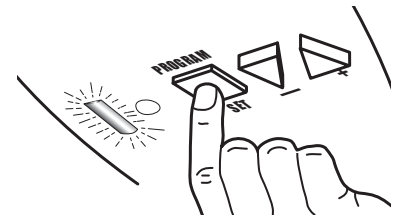

2. Lights go out and Round **BLUE** light comes ON.

3. Press  again and both lights flash **purple**.



4. Press both  and  simultaneously on the powerhead and hold until both LEDs flash **BLUE**.

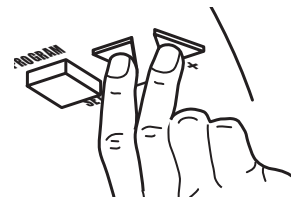

- Verify memory is cleared. Press a remote button that was previously programmed to the powerhead. Remote will not activate door opener.
- Garage door opener will operate normally using wall console.
- Program remaining or new remotes as shown on page 9. *Your door opener will no longer recognize any signal received from the missing remote, or any other which has not been reprogrammed to the powerhead.*



### ATTENTION

If your garage door opener has a Serial Number sticker which looks like this, in which the **first two numbers are 10** or higher, your opener is equipped with **CODEDODGER® 2**.



If you have another garage door opener that does NOT have a Serial Number like this, then you will be using the **CODEDODGER® 1** setting on your remote to operate that opener.

## CODEDODGER® FEATURES

Other models of Overhead Door garage door openers, remotes, and wireless keypads use **CodeDodger® 1** signals to communicate. Remotes provided with this unit will transmit either **CodeDodger® 1** or **CodeDodger® 2** signals.

**Remote(s) contained in this package are preset to CodeDodger® 2** and can be configured to communicate with previously installed **CodeDodger® 1** openers. This dual **CodeDodger®** option allows one **CodeDodger® 2** remote to operate different models of Overhead Door garage door openers.

This new Overhead Door garage door opener will **ONLY** accept signals from a remote sending **CodeDodger® 2** signals (see page 9) or an Overhead Door brand **CodeDodger® 1** remote that has been programmed to the opener using a new **CodeDodger® 2** remote (see page 10).

**NOTE:** Other remotes not enabled with Overhead Door **CodeDodger® 2** will not operate this opener.

If you have ...	Use this CodeDodger® programming
One or more <b>CodeDodger® 2</b> openers with a maximum 3 different openers	Use <b>CodeDodger® 2</b>
Mixture of openers manufactured between 1997 and 2010 ( <b>CodeDodger® 1</b> ) and new <b>CodeDodger® 2</b> openers	Use <b>CodeDodger® 2</b> and/or <b>CodeDodger® 1</b>
One or more openers manufactured between 1997 and 2010 ( <b>CodeDodger® 1</b> )	Use <b>CodeDodger® 1</b>

**NOTE:** A maximum of 3 different openers can be programmed to a 3 button remote.

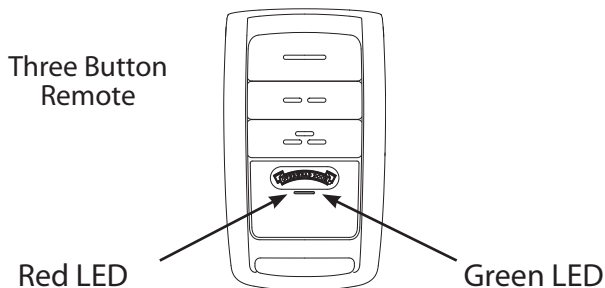

## Programming remote to previously installed CodeDodger® 1 Overhead Door garage door openers

Remotes provided with this unit can operate other (**CodeDodger® 1**) models of Overhead Door garage door openers. The default **CodeDodger® 2** setting must be changed to **CodeDodger® 1**. (Follow these same steps to change **CodeDodger® 1** back to **CodeDodger® 2**.)

**The LED color displayed on the remote indicates the CodeDodger® mode.**

**Red = CodeDodger® 1 / Green = CodeDodger® 2**

1. Select a button on the remote that has NOT been programmed to the new powerhead.
2. Press and hold that button for **10 seconds**. **Both Red and Green LEDs** come ON and stay ON.

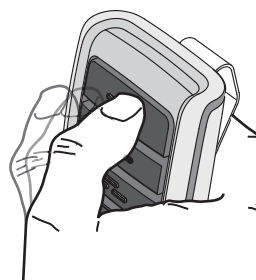
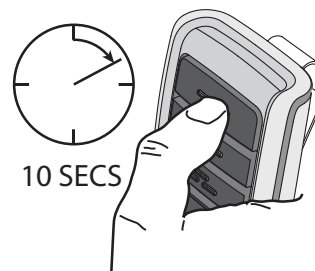

3. Press the same button **twice** to toggle **CodeDodger®** selection from **CodeDodger® 2** to **CodeDodger® 1**.

4. Press the same button **again** to confirm toggle. The **CodeDodger®** selection for this button is set to **CodeDodger® 1**.



5. Take the remote to the **CodeDodger® 1** Overhead Door garage door opener and follow that opener's instructions to program a new remote.

Repeat for other Overhead Door garage remote(s) as necessary.



## TRANSMITTER COMPLIANCE STATEMENT

Transmitters comply with all United States and Canadian legal requirements as of the date of manufacture. No warranty is made that they comply with all legal requirements of any other jurisdiction. If transmitters are to be used in another country, the importer must determine compliance with any local laws and regulations which may differ from United States and Canadian requirements prior to use.

Los transmisores cumplen con todas las reglamentaciones legales de los Estados Unidos y del Canadá, en la fecha de fabricación. Ninguna garantía se da que cumplan con todas las reglamentaciones legales de ninguna otra jurisdicción. Si los transmisores se van a utilizar en otro país, el importador debe determinar si cumplen con las reglamentaciones y leyes locales que puedan ser diferentes a las reglamentaciones de los Estados Unidos y del Canadá, antes de usar los mismos.

Les émetteurs sont conformes à la réglementation américaine et canadienne à compter de leur date de fabrication. Aucune garantie n'est stipulée indiquant qu'ils sont conformes à toutes les prescriptions juridiques d'autres autorités. Si les émetteurs sont utilisés dans d'autres pays, il incombe à l'importateur d'en déterminer leur conformité aux lois et règles locales pouvant différer de celles des États-Unis et du Canada avant toute utilisation desdits émetteurs.

Sendegeräte entsprechen allen gesetzlichen Bestimmungen in den USA und Kanada zum Zeitpunkt der Herstellung. Wir übernehmen keine Gewährleistung für die Einhaltung aller gesetzlichen Bestimmungen in anderen Ländern. Sollen Sendegeräte in anderen Ländern eingesetzt werden, so muss der Importeur vor dem Gebrauch sicherstellen, dass die Sendegeräte auch solchen lokalen Bestimmungen entsprechen, welche von den Bestimmungen der USA und Kanadas abweichen.

截止于制造日期,传动装置符合美国和加拿大的所有法律要求。不提供传动装置符合任何其他司法地区所有法律要求之担保。如果传动装置需在任何其他国家使用,进口商必须在使用之前确定装置符合与美国和加拿大要求不同之所有地方法规条例。

トランスミッターは、製造日付けのアメリカ合衆国及びカナダの法的条件に準拠します。しかしながら、トランスミッターがアメリカ合衆国及びカナダ以外の国の法的条件に準拠するかどうかは一切保証できません。トランスミッターがアメリカ合衆国及びカナダ以外の国で使用される場合、同製品の使用に先立つ法規制がこれらの国々と異なることがあるため、輸入者は同製品が輸入国の法規制に準拠することを確認しなければなりません。

트랜스미터들은 미국과 캐나다 전역에서 제조 날짜를 명기해야 하는 요구사항에 따라야 합니다. 기타 다른 관할권의 모든 법적인 요구 사항에 따라야 하는 책임은 없습니다. 만일 트랜스미터들이 기타 다른 지역에서 사용될 경우 수입업자는 사용하기에 앞서 미국과 캐나다와의 요구사항과는 다를지도 모르는 그 지역의 법과 조례에 따라야 할지의 여부를 결정해야 합니다.

## 6 MAINTENANCE & TROUBLESHOOTING

FOR HELP-1.800.929.3667 OR WWW.OVERHEADDOOR.COM

If you have any questions, please do not hesitate to contact customer service at: **1.800.929.3667**

## IMPORTANT SAFETY INSTRUCTIONS

### **⚠ WARNING: To reduce the risk of severe injury or death:**

- 1. READ AND FOLLOW ALL INSTRUCTIONS.**
- Never let children operate or play with the door controls. Keep the remote away from children.
- Always keep the moving door in sight and away from people and objects until the door is completely closed. **NO ONE SHOULD CROSS THE PATH OF THE MOVING DOOR.**
- NEVER GO UNDER A STOPPED, PARTIALLY OPEN DOOR.**
- Test opener monthly. The door **MUST** reverse on contact with a 1-1/2" high object (or a 2" x 4" board laid flat) at the center of the doorway on the floor. After adjusting either the force or the limit of travel, retest the door opener. Failure to adjust the opener properly may cause severe injury or death.
- When possible, use the emergency release only when the door is closed. Use caution when using this release with the door open. Weak or broken springs are capable of increasing the rate of door closure and increasing the risk of severe injury or death.
- KEEP DOORS PROPERLY BALANCED.** See your garage door Owner's Manual. An improperly balanced door increases the risk of severe injury or death. Have a trained door system technician make repairs to cables, spring assemblies, and other hardware.
- 8. SAVE THESE INSTRUCTIONS.**

## WARNING

- Garage door hardware (springs, cables, brackets, pulleys, etc.) are under extreme pressure and tension.
- **DO NOT** attempt to repair or adjust door springs or any hardware, and **DO NOT OPERATE** garage door **automatically or manually** if door is improperly balanced or springs are broken.
  - **CONTACT A TRAINED DOOR SYSTEM TECHNICIAN.**

## ROUTINE MONTHLY MAINTENANCE

Basic monthly maintenance tasks.

- **Safe-T-Beam® System Check**
- **Door balance**
- **Contact reverse**

Instructions for these tasks and others are found on the following pages.

## DOOR BALANCE (SPRING TENSION)

- With the door closed, pull  release handle DOWN and let go to release door carriage assembly from drive system.
- Raise door manually approximately 3' - 4' and release.
  - Door should remain stationary or move very slightly.
  - If door moves quickly, **CONTACT A TRAINED DOOR SYSTEM TECHNICIAN.**
- Close the door.
- Verify RED block in carriage is in the up position.
  - Operate door using remote or wall console.
  - Door will re-attach itself to carriage assembly.

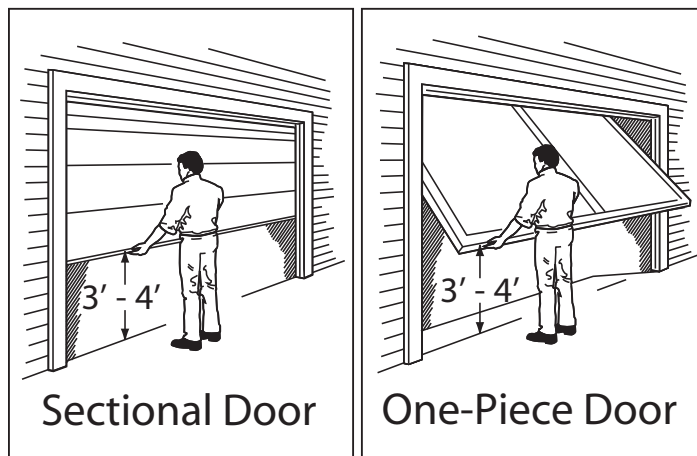

FIG. 6-1 Door balance

## CONTACT REVERSE TEST (Monthly test)

The Force and Limit settings **MUST** be **COMPLETED** before testing. (See pages 6-7)

### 1. Test.

- Open garage door using wall console.
  - Place a 2" x 4" board (laid flat) under **center of garage door opening** (Fig. 6-2).
- Close garage door using wall console.
- When door contacts board, the door must stop (within 2 seconds) and reverse direction returning to open position.

### 2. Adjustment.

- If the door:
  - Stops before it contacts the 2 x 4 board, it may simply be responding to an improperly set down limit. Return to pages 6-7 and repeat steps 1 through 10 to correct down limit.

- Stops after contacting the 2 x 4 board and does not reverse, it may need an adjustment to the down limit. Return to pages 6-7 and repeat steps 1 through 10 to correct down limit.
- Test again. Repeat as necessary until door reverses upon contacting board.

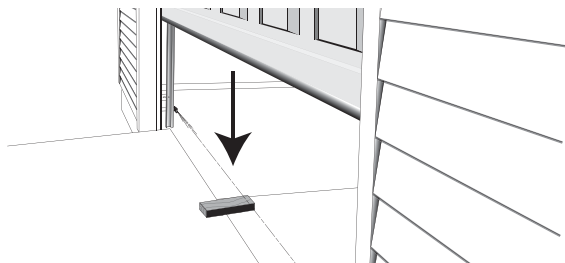

FIG. 6-2 2 x 4 under center of door opening

## WARNING

Use wall console supplied with opener. Other **approved** wall consoles may be available. Unapproved or incompatible wall consoles can cause the opener to operate unexpectedly.

## Safe-T-Beam® (STB) SYSTEM CHECK

- STB Red and Green LEDs ON steady, system OK
- STB Red LED flashes
  - Check for obstruction
  - Check alignment
  - Verify wire routing from STBs to STB connection in powerhead
  - Check for signal interference from another Safe-T-Beam® unit
- No STB Red or Green LED displayed
  - Check wiring and wire connections

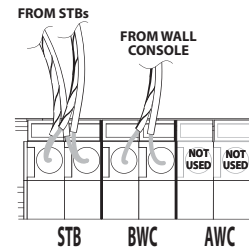



## CHANGE LIGHT BULBS

### WARNING

- Observe all safety warning and precautions! Improper light bulb removal or replacement could result in Death or Serious Injury.
- Disconnect power from opener before beginning this task.
- When replacing light cover, make sure wires are not pinched or near moving parts

### 1. Disconnect power to door opener.

- Open powerhead light cover.
- Remove light bulb(s).
- Replace with maximum 100 Watt light bulb(s).
  - **Do NOT** use light bulbs with greater than 100 Watt rating.
- Close powerhead light cover.

### 2. Reconnect power to door opener.

- Test light operation.



## MOTION DETECTOR\* - OVERVIEW

### (Not available on all models)

Powerheads equipped with a motion detector provide additional security when exiting or entering the garage area.

\*This sensor works by detecting body heat. Range of detection may be reduced when the temperature in the garage is close to body temperature.

**NOTE:** Detector positioning on the powerhead provides for monitoring *below* the powerhead.

### OPERATION

- Detector sensor is always **ON**. There are **NO** user controls or adjustments.
- Lights automatically turn **ON** when a change is detected and will turn **OFF** after 4 minutes of no change.
- Motion detector sensor will not turn **OFF** lighting turned **ON** at the wall console.
- Lighting turned **ON** at the wall console will remain **ON** until wall console turns lighting **OFF** or opener is used.

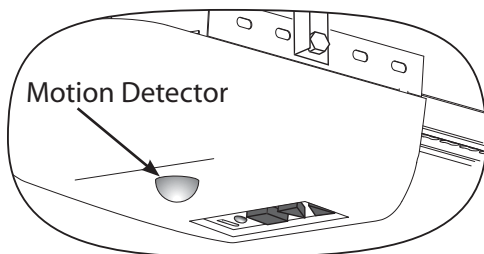

## RESET - OPEN/CLOSE TRAVEL LIMIT

Performing **all ten (10) Limits/Force setting steps** (pages 6-7) erases previous Limits/Force settings.

**NOTE: The opener will not close the door automatically unless the Safe-T-Beam® System is installed and Limits are programmed.**

## CARRIAGE ENGAGE/DISENGAGE

Use Release Handle to manually connect or release chain or belt bullet to Carriage.

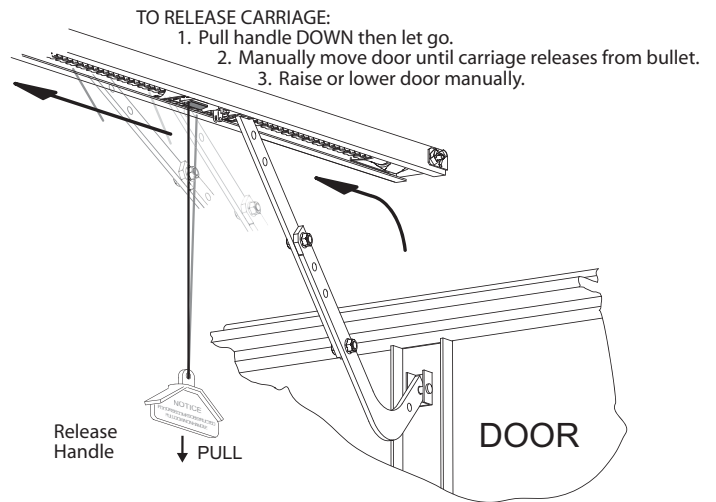

TO RECONNECT CARRIAGE:  
 1. Verify RED block is in the UP position.  
 2. Manually move door until carriage engages bullet.  
 3. Raise or lower door using remote or wall console.

FIG. 6-3 Carriage Release

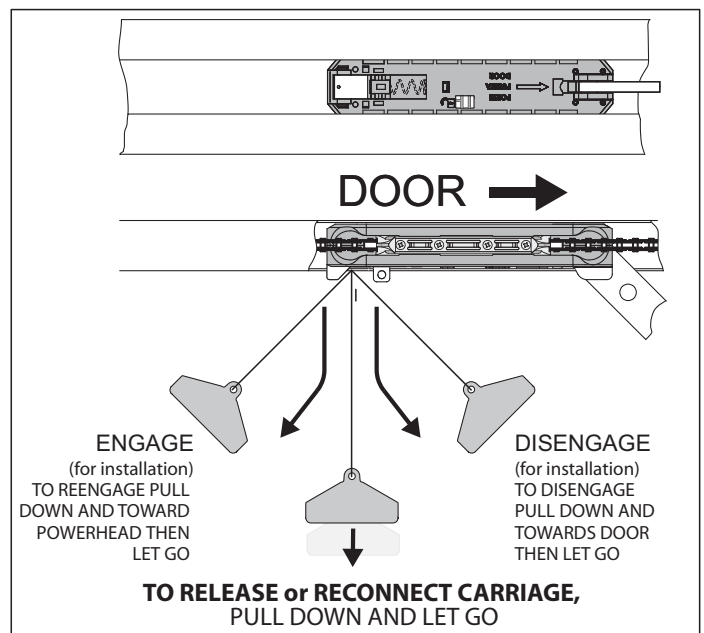
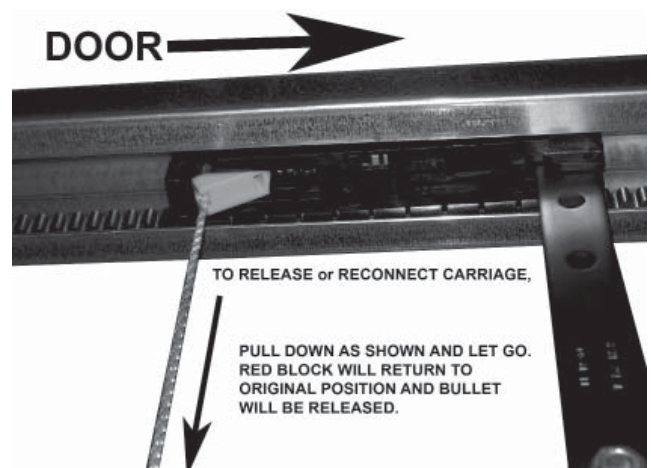

FIG. 6-4 Carriage (cut away view)

This opener has a Serial Number sticker in which the serial numbers begin with 10 or higher.

**ATTENTION**

If your garage door opener has a Serial Number sticker which looks like this, in which the *first two numbers are 10 or higher*, your opener will operate using this Series III wall control.

MODEL AC SR3      THE OVERHEAD DOOR CORP.  
 FCC ID: 200 AC SR3      Residential Door Operator  
 IC: 2353A-C581D      120V, 60HZ, 5A

S/N: 10XXXXX XXXXXXXX

FOR MORE INFORMATION: 1-800-275-5187 / WWW.OVERHEADDOOR.COM

**Follow the instructions on this page.**

Wall consoles from other manufacturers may not work with openers of these serial number groups. Overhead Door Series I wall buttons and Series II wall consoles will not work with openers of this serial number group.

**WALL CONSOLE - OVERVIEW**

Use only the Series III wall console provided with this unit.

Wall console has three buttons and one indicator light.

**Indicator Light**

Indicator light will display Red when wall console is properly wired and Sure-Lock™ is OFF. When Sure-Lock™ is ON indicator light flashes.

**Open/Close Button**

Use this button to open or close garage door. When Sure-Lock™ is ON the Open/Close button will CLOSE door only. **Note:** Constant button pressure in the CLOSE mode will override error responses in the powerhead and close door.

**Independent Light Control Button**

Use this button to turn powerhead lights ON. Powerhead lighting will remain ON until this button is pressed again or a door action has been completed. **Note:** If opener has a Motion Detector sensor the sensor will keep powerhead lights ON as long as motion is detected.

**Sure-Lock™ Button**

When Sure-Lock™ is ON the powerhead cannot be activated by the wall console or a remote.

- Press and hold for 5 seconds (or until Indicator Light flashes) to activate Sure-Lock™.
- Press and release to turn Sure-Lock™ OFF.

**Open/Close Button**

Open and closes door from inside garage

**Sure-Lock™ Button**

- LOCK disables controls after door is completely closed
- UNLOCK allows controls to work normally

**Indicator Light**

Red indicator light is always ON  
 When Sure-Lock™ is ON the indicator light flashes



**Independent Light Control Button**

- Controls door opener lights from inside garage

**Tip:** If indicator light on wall console comes ON, but there is NO operation from buttons - verify wall console wire routing at powerhead connector.

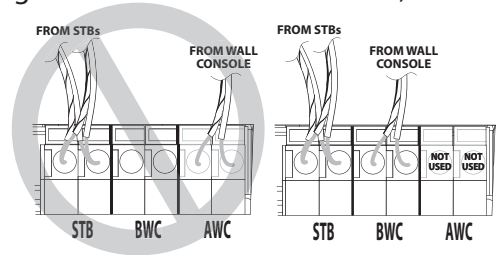

**OPTIONAL DUAL WALL CONSOLE - INSTALLATION**

Use only a Series III wall console provided when adding a second wall console. The *optional second* Overhead Door Series III wall console must be purchased separately.

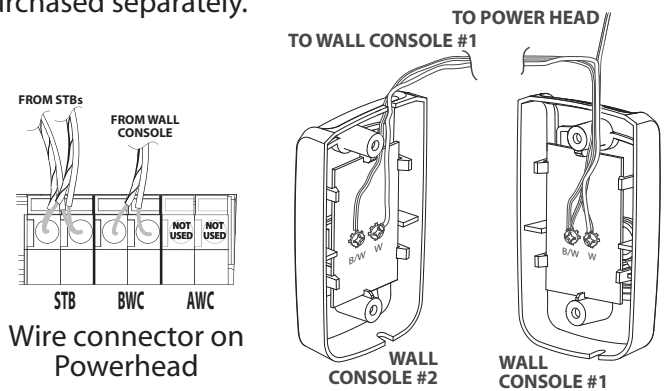

OR

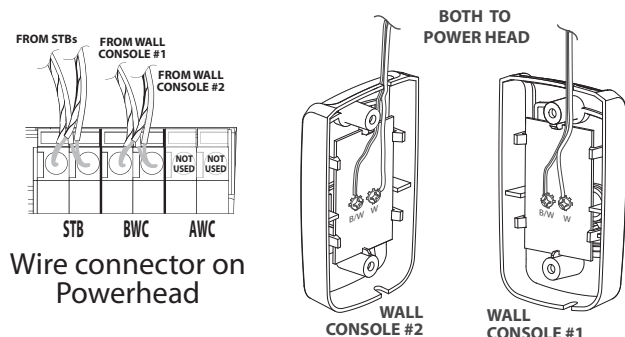

## CHAIN OR BELT - TENSION ADJUSTMENT

### WARNING

- Observe all safety warning and precautions! Improper tension could result in Death or Serious Injury.
- Disconnect power from opener before beginning this task.

Visually inspect the chain or belt every 6 months.

**NOTE:** Tension adjustments should be made with the door in the down position and the carriage released.

- At the center of the rail the chain or belt should not be resting on the rail. See adjustment illustration on right.
  - With the bullet NOT engaged to the carriage, tighten adjustment nut until chain/belt does not, at the center of the rail, rest on rail. Do NOT overtighten.
- Is there rust on chain or frayed edges on belt?
  - Contact a trained door system technician for chain/belt replacement.
- Are there kinks or twists in the chain or belt?
  - Contact a trained door system technician for chain/belt replacement.

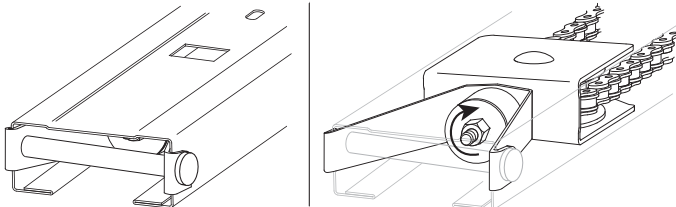

Tighten nut to **increase** tension on chain or belt

Adjustment required

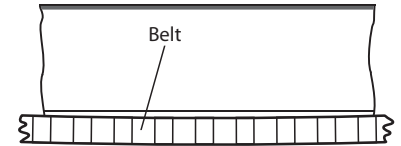

Correctly adjusted

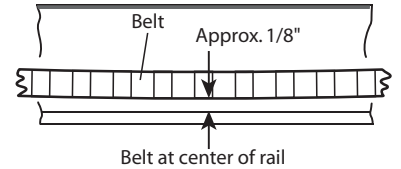

## BELT

Adjustment required

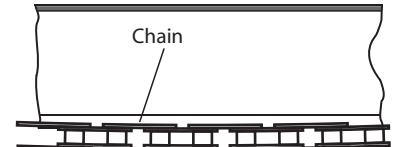

Correctly adjusted

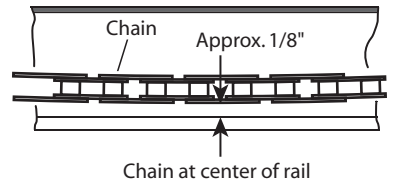

## CHAIN

## REMOTE BATTERY REPLACEMENT

Replace remote battery with a CR 2032 coin cell battery.

1. Open the remote case using a washer or coin that fits into the slot at the side of the remote.
2. Replace battery.
3. Align components and snap case closed.

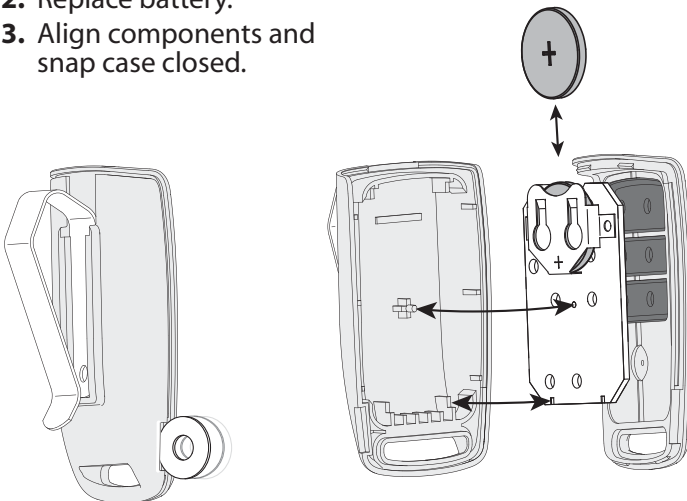

Speed settings are pre-programmed at the factory for the maximum speed. Speed settings should not need adjustment with this unit.









However, travel speed for the opener can be adjusted to slower speeds to minimize normal wear for heavy sectional doors.







**NOTE:** One piece doors are automatically set during Limits programming to the slowest speed and opener speed cannot be reset for one piece doors.

**CHANGE SPEED SETTING**

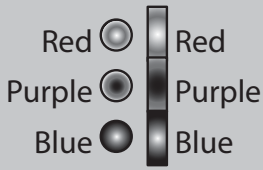
Use this guide to ADJUST powerhead SPEED settings.

There are three (3) Speed settings available on this unit. Door type (one piece or sectional), door weight and balance, and condition of door components / track affect door speed. Speed adjustment may not be available for some installations depending on these factors.

1. Press  on the powerhead and hold until both lights turn steady ON. Release button. Lights go out and Round BLUE light comes ON.
2. Press  **two** times and the Round BLUE and Long BLUE lights come ON.
3. Press  once to enter the Speed Programming menu. The round LED will flash BLUE 3 times, then the *current* Speed setting **for UP travel** will display on the LEDs. See table below.
4. Press  to raise or  to lower **UP Speed settings** within the available range.  
**NOTE:** Faster door speeds may not be available.
5. Press  to **set UP Speed level**. The long LED will flash BLUE 3 times, then the *current* Speed setting **for DOWN travel** will display on the LEDs.
6. Press  to raise or  to lower **DOWN Speed settings** within the available range.  
**NOTE:** Faster door speeds may not be available.
7. Press  to **set DOWN Speed level**. Both LEDs flash BLUE to confirm.

Speed Level	Powerhead LEDs	
	Round LED	Long LED
Default LED display is the current Speed setting		
LED Speed indicator colors		
Speed Level LED indicator colors		
MAXIMUM	Red ON 	 Red ON
MID	Purple ON 	 Purple ON
SLOW	Blue ON 	 Blue ON

**CAUTION**

Door closing force is FACTORY set and requires no adjustment for *normal* operation.

- Never increase the door closing force to compensate for a damaged door or a binding door track.
- Never adjust force to compensate for a broken door spring.
- Perform monthly CONTACT REVERSE TEST as described on page 18.

Force settings are pre-programmed at the factory and "learned" during the Open/Close Limit settings steps. Some additional Force may be increased. For normal use, Force settings should not need adjustment with this unit.









However, conditions that might suggest an adjustment is necessary are;























- Doors with very stiff weather seals.
- Doors that start down, then STOP and reverse before they close.
- Doors that start up, but STOP before they completely open.

**CHANGE FORCE SETTING**

Use this guide to ADJUST powerhead FORCE settings.

**NOTE:** There are nine (9) force levels.

1. Press  on the powerhead and hold until both lights turn steady ON. Release button. Lights go out and Round BLUE light comes ON.
2. Press  **three** times, Round RED light comes ON.
3. Press  once to enter the Force Programming menu. The round LED will flash BLUE 3 times, then the *current* Force setting **for UP force** will display on the LEDs. See table below.
4. (If current UP Force setting is good, skip to Step 5.) Press  to increase or  to decrease **UP Force settings** within the available range.
5. Press  to **set UP Force level**. The long LED will flash BLUE 3 times, then the *current* Force setting **for DOWN force** will display on the LEDs.
6. (If current DOWN Force setting is good, skip to Step 7.) Press  to increase or  to decrease **DOWN Force settings** within the available range.
7. Press  to **set DOWN Force level**. Both LEDs flash BLUE to confirm.

Force Level	Powerhead LEDs	
	Round LED	Long LED
Default LED display is the <i>current</i> Force setting		
LED indicator colors  OFF,  Blue,  Purple,  Red		
Force Level LED indicator colors		
Force Level 1	Blue ON 	 OFF
Force Level 2	OFF 	 Blue ON
Force Level 3	Blue ON 	 Blue ON
Force Level 4	Purple ON 	 OFF
Force Level 5	OFF 	 Purple ON
Force Level 6	Purple ON 	 Purple ON
Force Level 7	Red ON 	 OFF
Force Level 8	OFF 	 Red ON
Force Level 9	Red ON 	 Red ON

**TROUBLESHOOTING GUIDE - OPERATION** .....FOR HELP-1.800.929.3667 OR WWW.OVERHEADDOOR.COM

PROBLEM	WHAT TO DO
<p><b>Opener does NOT run from wall console.</b></p>	<ul style="list-style-type: none"> <li>• Check power source,                             <ul style="list-style-type: none"> <li>– Plug a lamp into outlet used for powerhead. If lamp works, power source is OK.</li> <li>– If not, check fuse or circuit breaker.</li> </ul> </li> <li>• If power is OK,                             <ul style="list-style-type: none"> <li>– Check connections at powerhead terminals and at wall console.</li> <li>– Limits must be set with door arm connected to door.</li> </ul> </li> <li>• Check if wall console Sure-Lock™ is ON. Turn Sure-Lock™ OFF &amp; check operation.</li> <li>• Check for reversed, broken, or cut wires. Staples can cut insulation and short wires. Repair or replace.</li> </ul>
<p><b>Opener runs, but door does NOT move.</b></p>	<ul style="list-style-type: none"> <li>• Make sure carriage is engaged to chain or belt bullet. See pages 11 and 19. Refer to Installation poster or download poster from WWW.OVERHEADDOOR.COM.                             <ul style="list-style-type: none"> <li>– Ensure carriage is in engaged position. See page 19.</li> </ul> </li> <li>• Check to make sure chain/belt is not broken or OFF its pulley or drive sprocket.</li> <li>• Check FORCE ADJUSTMENT. See page 23.</li> </ul>
<p><b>Opener works from wall console, but NOT from remote.</b></p>	<ul style="list-style-type: none"> <li>• Check all remotes.</li> <li>• Replace remote battery with good one. See page 21.</li> <li>• Program remote to powerhead. See pages 9 or 10.</li> </ul>
<p><b>Remote has less than 25 feet operating range or no operation.</b></p>	<ul style="list-style-type: none"> <li>• Relocate remote inside car and or point remote at garage door.</li> <li>• Replace battery. See page 21.</li> <li>• Reposition door opener antenna.</li> <li>• Remote LED does not come ON with button push - replace battery. See page 21.</li> <li>• Eliminate possible competing signals (satellite radio, FiOS® TV).</li> </ul>
<p><b>Door starts down, then STOPS and goes back up.</b></p> <p><b>OR</b></p> <p><b>Safe-T-Beam® System malfunction.</b></p>	<ul style="list-style-type: none"> <li>• If a NEW installation, check Door Arm position. Refer to Installation poster or download poster from WWW.OVERHEADDOOR.COM</li> <li>• Check if Limits are properly set. See pages 6-7.</li> <li>• Check if Safe-T-Beam® Red LED is flashing. See page 18.</li> <li>• Check Safe-T-Beam® system for beam obstruction or misalignment of lenses. See page 18.</li> <li>• Check garage door for binding.</li> <li>• If an operational problem exists, and opener will not close. The opener can be forced to close as follows; Press and hold the wall console button until door is completely closed.</li> <li>• Check for interference from adjacent Safe-T-Beam® units.</li> <li>• Contact Overhead Door Corporation at 1.800.929.3667.</li> </ul>
<p><b>Door starts down, then STOPS before it is closed.</b></p> <p><b>OR</b></p> <p><b>Door will only open.</b></p>	<ul style="list-style-type: none"> <li>• Check Safe-T-Beam® wire connections at powerhead. See page 18.</li> <li>• Check Limits are properly set. See pages 6-7.</li> <li>• Check CONTACT REVERSE. See page 18.</li> <li>• Check garage door for binding.</li> <li>• Check <i>closing</i> "FORCE" adjustment. See page 23.</li> </ul>
<p><b>Door starts up, but STOPS before it is completely open.</b></p>	<ul style="list-style-type: none"> <li>• Check Limits are properly set. See pages 6-7.</li> <li>• Be sure door, opener, and springs are in good repair, properly lubricated and balanced.</li> <li>• Check opening "FORCE" adjustment. See page 23.</li> <li>• <b>▲ WARNING:</b> If you suspect a problem with the garage door hardware or springs, contact Overhead Door Corporation at 1.800.929.3667.</li> </ul>
<p><b>Door will only run closed.</b></p>	<ul style="list-style-type: none"> <li>• Check Limits are properly set. See pages 6-7.</li> <li>• Check Sure-Lock™. Sure-Lock™ should be OFF for normal operation. See page 20.</li> <li>• Check door balance, condition, and door spring.</li> <li>• Check <i>opening</i> "FORCE" adjustment. See page 23.</li> <li>• <b>▲ WARNING:</b> If you suspect a problem with the garage door hardware or springs, contact Overhead Door Corporation at 1.800.929.3667.</li> </ul>
<p><b>Door opener starts for no reason.</b></p>	<ul style="list-style-type: none"> <li>• Button stuck on wall console or remote.</li> <li>• Was a remote lost or stolen? Erase all remote codes from powerhead memory and program new remotes. See page 15.</li> </ul>



PROBLEM	WHAT TO DO
<b>Noisy operation.</b>	<ul style="list-style-type: none"> <li>• Be sure all door fasteners are tight.</li> <li>• Be sure garage door is in good repair, properly lubricated and balanced.</li> <li>• Be sure opener is in good repair.</li> </ul>
<b>Door opener runs slow.</b>	<ul style="list-style-type: none"> <li>• Check operating condition of door. See page 18. Door may need professional repair/adjustment.</li> <li>• Is this opener installed on a one piece door? Normal speed for one piece door is lowest speed setting.</li> <li>• If carriage travel is less than 6 feet, opener configures programming for a one piece door.</li> <li>• Check door speed. See page 22.</li> </ul>

Powerhead LED		Possible Problem	Solution
Round LED	Long LED		
OFF	OFF	Normal operation	None required
		No response from unit	Check power supply Contact a trained door system technician
ON/RED/STEADY	ON/RED/STEADY	Limits NOT set properly	Reprogram Limits, see pages 6-7
ON/RED/FLASHING	ON/RED/FLASHING	Program error	Unplug unit, wait 5 seconds, plug in
		Component failure	Contact a trained door system technician
ON/BLUE/FLASHING	OFF	Remote NOT programmed	Program remote, see page 9
ON/PURPLE/FLASHING	OFF	CodeDodger® 1 remote NOT programmed	Program remote using CodeDodger® 2 remote, see page 9, then program CodeDodger® 1 remote using instructions on page 10
ON/RED/FLASHING	OFF	Safe-T-Beam® physical obstruction	Remove obstruction, recheck unit
		Safe-T-Beam® signal interference	Check alignment of Safe-T-Beam® pair and nearest other Safe-T-Beam® pair
OFF	ON/RED/FLASHING	Door contact in up or down travel	Remove obstruction
		Door component failure detected	Check door spring, track, rollers, hinges and fixtures
OFF	ON/RED/STEADY	Thermal cutout	DO NOT unplug unit Wait until LED clears before operating

# REFERENCE - CIRCUIT WIRING DIAGRAM

FOR HELP-1.800.929.3667 OR WWW.OVERHEADDOOR.COM

RÉFÉRENCE - DIAGRAMME DE CÂBLAGE DE CIRCUIT ..... POUR OBTENIR DE L'AIDE-1.800.929.3667

REFERENCIA - ESQUEMA ELÉCTRICO DEL CIRCUITO ..... PARA OBTENER AYUDA, LLAME AL 1.800.929.3667

**Opener circuit wiring diagram. This wiring diagram is for reference only.**

Schéma de câblage de l'ouvreuse. Ce schéma de câblage est indiqué à titre de référence uniquement.

Diagrama del circuito del operador. Este diagrama es sólo para referencia.

**WARNING**

**AVERTISSEMENT**

**ADVERTENCIA**

**Opening Cover May Cause Electric Shock.**

L'ouverture du couvercle peut entraîner des chocs électriques.

Abrir la tapa puede causar choques eléctricos.

**Disconnect power from opener prior to removing cover.**

Coupez l'alimentation de l'ouvreuse avant de retirer le couvercle.

Desconecte la electricidad del abrepuertas antes de quitar la cubierta.

## POWER CORD

CORDON DE SECTEUR

CABLE ELÉCTRICO

**CONNECTOR**  
CONNECTEUR  
CONECTADOR

**PRINTED CIRCUIT BOARD**  
CIRCUIT IMPRIMÉ  
CIRCUITO IMPRESO

**CHAIN/BELT MOTOR**  
CADENA/CORREA MOTEUR  
CHAÎNE/COURROIE MOTOR

**SCREW DRIVE MOTOR**  
IMPULSION DEL  
TORNILLO MOTEUR  
COMMANDE DE VIS MOTOR

WHITE  
BLANC  
BLANCO

BLACK  
NOIR  
NEGRO

GREEN  
VERT  
VERDE

**CHOKE**  
BOBINE D'ARRÊT  
BOBINA DE CHOKE

WHITE  
BLANC  
BLANCO

BLACK  
NOIR  
NEGRO

BLACK  
NOIR  
NEGRO

BLACK  
NOIR  
NEGRO

RED  
ROUGE  
ROJO

RED  
ROUGE  
ROJO

BLACK  
NOIR  
NEGRO

STRIPED WHITE  
BLANC RAYÉ  
BLANCO RAYADO

**SAFE-T-BEAM®**  
SAFE-T-BEAM®  
SAFE-T-BEAM®

STRIPED WHITE  
BLANC RAYÉ  
BLANCO RAYADO

(Purchased Separately)  
**ADVANCED WALL CONSOLE**  
CONSOLE AVANÇÉE DE MUR  
CONSOLA AVANZADA  
DE LA PARED

**WALL CONSOLE**  
CONSOLE DE MUR  
CONSOLA DE LA PARED

FIG. 6-5

**WARNING**

**AVERTISSEMENT**

**ADVERTENCIA**



**ELECTRICAL SHOCK**  
CHOC ÉLECTRIQUE  
CHOQUE ELÉCTRICO

**MOTION DETECTOR\***  
DÉTECTEUR DE MOUVEMENT  
DETECTOR DE MOVIMIENTO

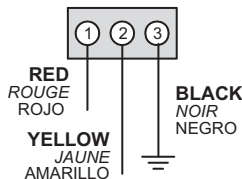

**OPTICAL SENSOR\***  
SONDE OPTIQUE  
SENSOR ÓPTICO

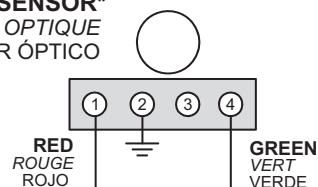

\*SOME MODELS DO NOT COME WITH THIS FEATURE  
QUELQUES MODÈLES NE VIENNENT PAS AVEC CETTE CONFIGURATION  
ALGUNOS MODELOS NO VIENEN CON ESTA CARACTERÍSTICA

**The Genuine. The Original.**



**Destiny™ 1200  
Limited Warranty**

The Distributor of Overhead Door Corporation products, whose name appears below ("Seller") warrants to the original purchaser of the Destiny™ 1200 garage door opener, Model 8030 and 8030H ("Product"), subject to all of the terms and conditions hereof, that the Product and all components thereof will be free from defects in materials and workmanship for the following period(s) of time, measured from the date of installation:

- **MOTOR/GEARBOX** - Seller warrants the motor/gearbox for the **LIFETIME\*** of the product
- **BELT** - Seller warrants the belt for a period of **FIFTEEN (15) YEARS.**
- **CHAIN** - Seller warrants the chain for a period of **FIVE (5) YEARS.**
- **CORE UNIT PARTS\*\*** - Seller warrants all other parts and components of the **Core Unit** for a period of **FIVE (5) YEARS.**
- **ACCESSORIES** - Seller warrants all accessories for a period of **ONE (1) YEAR**

\*Lifetime shall mean as long as the original purchaser owns the home in which the product is originally installed.

\*\* The Core Unit consists of the powerhead, wired wall control, Safe-T-Beam® system, J-Arm and rail.

Seller's obligation under this warranty is specifically limited to repairing or replacing, at its option, the Product or any part thereof which is determined by Seller to be defective during the applicable warranty period. Any labor charges are excluded and will be the responsibility of the purchaser.

This warranty gives you specific legal rights, and you may also have other rights which vary from state to state. This warranty is made to the original purchaser of the Product only, and is not transferable or assignable. This warranty applies only to Product installed in a residential or other non-commercial application. It does not cover any Product installed in commercial or industrial building applications. This warranty does not apply to any unauthorized alteration or repair of the Product, or to any Product or component which has been damaged or deteriorated due to misuse, abuse, neglect, accident, failure to provide necessary maintenance, normal wear and tear, or acts of God or any other cause beyond the reasonable control of Seller, and does not cover batteries, or repairs or maintenance to door components.

ALL EXPRESS AND IMPLIED WARRANTIES FOR THE PRODUCT, INCLUDING BUT NOT LIMITED TO ANY IMPLIED WARRANTIES OF MERCHANTABILITY AND FITNESS FOR A PARTICULAR PURPOSE, ARE LIMITED IN TIME TO THE APPLICABLE WARRANTY PERIOD REFLECTED ABOVE. NO WARRANTIES, WHETHER EXPRESS OR IMPLIED, WILL APPLY AFTER THE LIMITED WARRANTY PERIOD HAS EXPIRED.

Some states do not allow limitations on how long an implied warranty lasts, so the above limitation may not apply to you.

IN NO EVENT SHALL OVERHEAD DOOR CORPORATION BE RESPONSIBLE FOR, OR LIABLE TO ANYONE FOR, SPECIAL, INDIRECT, COLLATERAL, PUNITIVE, INCIDENTAL OR CONSEQUENTIAL DAMAGES, even if Overhead Door Corporation has been advised of the possibility of such damages. Such excluded damages include, but are not limited to, loss of use, cost of any substitute product, or other similar indirect financial loss. Some states do not allow the exclusion or limitation of incidental or consequential damages, so the above limitation or exclusion may not apply to you.

Claims under this warranty must be made promptly after discovery, within the applicable warranty period and in writing to the Seller whose name and address appear below. The Purchaser must allow Seller a reasonable opportunity to inspect any product claimed to be defective prior to removal or any alteration of its condition. Proof of purchase and/or the installation date, and identification as the original purchaser may be required. Upon determination by Seller that the Product or any part thereof is defective during the applicable warranty period, Seller will supply the purchaser with replacement parts or, at its option, a replacement Product (shipping and handling of any replacement part(s) or replacement Product also at purchaser's expense). Seller may use new or reconditioned parts, or a new or reconditioned Product of the same or similar design.

There are no established informal dispute resolution procedures of the type described in the Magnuson-Moss Warranty Act.

DATE OF INSTALLATION: \_\_\_\_\_

NAME OF DISTRIBUTOR/INSTALLER: \_\_\_\_\_

ADDRESS OF DISTRIBUTOR/INSTALLER: \_\_\_\_\_