

Lift-Master

The Chamberlain Group, Inc.
 A DUCHOSSOIS ENTERPRISE
 845 Larch Avenue, Elmhurst, Illinois 60126

Garage Door Opener Owner's Manual

FOR RESIDENTIAL USE ONLY

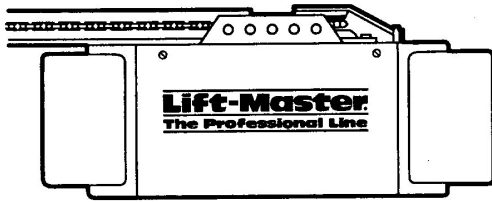

Model 1160- 1/2 HP
 Model 1150- 1/3HP

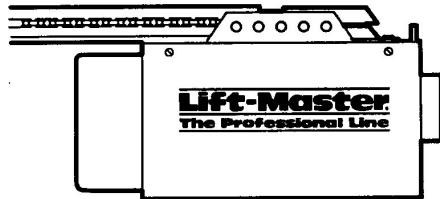

Model 1156- 1/2HP
 Model 1146 - 1/3HP

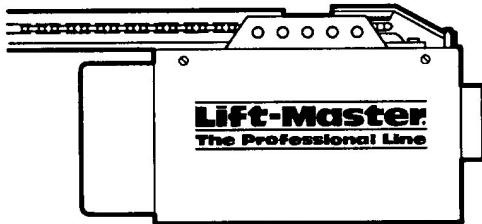

Model 1155 - 1/2HP
 Model 1145- 1/3HP

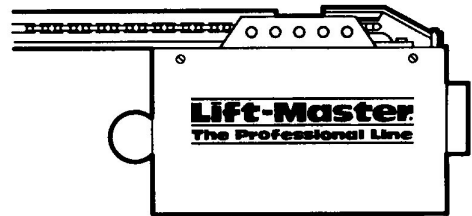

Model 1140- 1/4HP

CAUTION! PLEASE READ THIS MANUAL CAREFULLY

The MODEL NUMBER label is located on the front panel of your opener



THIS DEVICE COMPLIES WITH FCC RULES PART 15. Operation of this device is subject to the following two conditions: 1. This device may not cause harmful interference. 2.This device must accept any interference that may be received including interference that may cause undesired operation.

CONTENTS	PAGE	CONTENTS	PAGE
Safety Rules	2	Limit Adjustment.....	20
Carton Inventory	3	Force Adjustment.....	21
Features of Your Opener.....	3	Safety Reverse Test.....	22
Specifications	3	The Protector System™.....	22
Accessories	4	Setting/Changing Code	23
Completed Installation Illustration	5	Having a Problem?	24
Installation Information	5	Repair Parts, Rail Assembly.....	26
Operation of Your Opener.....	6	Repair Parts, Installation.....	26
Care and Maintenance of Your Opener.....	7	Repair Parts, Opener Assembly	27
Assembly.....	8	How To Order Repair Parts.....	28
Installation.....	10	Warranty	28

FASTEN THIS MANUAL NEAR THE GARAGE DOOR AFTER INSTALLATION.
 PERIODIC CHECKS OF THE OPENER ARE REQUIRED TO INSURE SATISFACTORY OPERATION.

ACCESSORIES

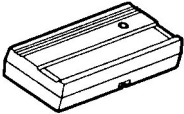
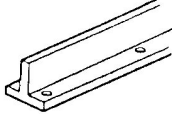
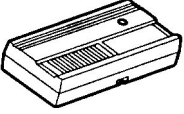
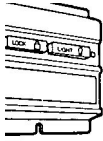
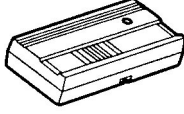
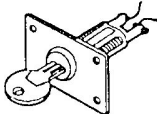
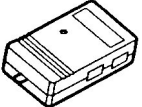
Many useful accessories are available for your garage door opener. They are illustrated below with model numbers and descriptions.

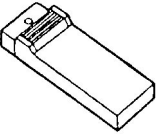
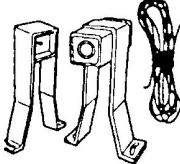
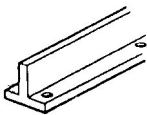
<p>Model 61LM</p> <p>STANDARD REMOTE CONTROL TRANSMITTER: Single-Function with visor clip</p> 	<p>Model 1710</p> <p>10-FT T-RAIL: Fully assembled 10-ft. T-rail with full chain. Allows 10-foot garage doors to open fully</p> 
<p>Model 62LM</p> <p>2-CHANNEL REMOTE CONTROL TRANSMITTER: With visor clip.</p> 	<p>Model 56</p> <p>MULTI-FUNCTION CONTROL PANEL: Provides a Lock Switch feature which prevents operation of garage door opener from remote control transmitters and a Light Switch feature for constant light.</p> 
<p>Model 63LM</p> <p>MULTI-FUNCTION REMOTE CONTROL TRANSMITTER: With visor clip.</p> 	<p>Model 60</p> <p>OUTSIDE KEYLOCK: Opens garage door automatically from outside when transmitter is not handy</p> 
<p>Model 64LM</p> <p>MINI MULTI-FUNCTION REMOTE CONTROL TRANSMITTER: With key ring.</p> 	<p>Model 1702</p> <p>OUTSIDE QUICK RELEASE LOCK: REQUIRED for a garage with NO service door. Allows manual operation of garage door from outside in case of power failure .</p> 
<p>Model 66LM</p> <p>KEYLESS ENTRY SYSTEM: Enables homeowner to operate garage door opener from outside by entering code on specially designed keypad.</p> 	<p>Model 70</p> <p>"THE PROTECTOR SYSTEM": Provides auxiliary support to the safety features built into your opener. The system's invisible beam, when broken by an obstruction, causes a closing door to open and prevents an open door from closing. Strongly recommended for homeowners with young children.</p> 
<p>Model 1708</p> <p>8-FT T-RAIL: Fully assembled 8-ft. T-rail with full chain. Allows 8-ft. garage doors to open fully</p> 	

BEFORE YOU BEGIN, PLEASE TAKE SOME TIME TO CAREFULLY EXAMINE THE ILLUSTRATIONS ON THE FOLLOWING PAGE OF A TYPICAL GARAGE DOOR OPENER INSTALLATION ON BOTH A SECTIONAL AND A ONE-PIECE DOOR.

Some installation instructions vary for sectional and one-piece doors. Follow only those instructions which apply to your door type.

Do you have a finished ceiling in your garage? If so, you will need a support bracket and additional fastening hardware. Refer to Step 4, Page 13 for specific requirements.

Do you have a lightweight or metal door (or does it have glass panels)? If so, horizontal and vertical reinforcement is required. Refer to Step 8, Page 17.

Adjustment

STEP 1 *Adjust UP and DOWN Limits*

LIMIT ADJUSTMENT settings regulate the points at which the door will stop when moving up or down.

NOTE: Door **STOPS** in the **UP** direction if anything interferes with door travel. Door **REVERSES** in the **DOWN** direction if anything interferes with the door travel (including binding or unbalanced doors).

PROCEDURE: To operate the opener, press the Door Control Button. Run the opener through a **COMPLETE TRAVEL CYCLE**. No limit adjustments are necessary when the door opens and closes completely and doesn't reverse unintentionally when fully closed.

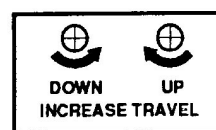
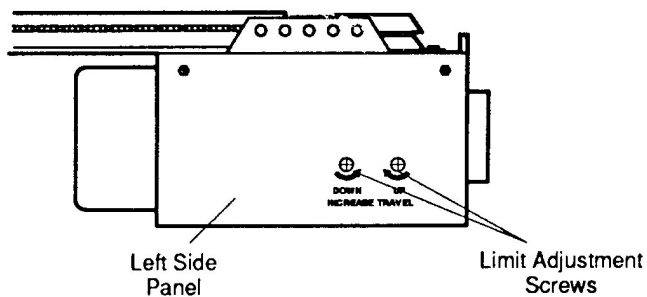

Adjustment Label

The following chart outlines adjustment procedures. Run the opener through a **COMPLETE TRAVEL CYCLE AFTER EACH ADJUSTMENT**.

NOTE: REPEATED OPERATION OF THE OPENER DURING ADJUSTMENT PROCEDURES MAY CAUSE MOTOR TO OVERHEAT AND SHUT OFF. SIMPLY WAIT 15 MINUTES AND TRY AGAIN.

Read the chart carefully before proceeding to Step 2. Use a screwdriver to make limit adjustments.

LIMIT ADJUSTMENT CHART

IF DOOR DOES NOT OPEN COMPLETELY BUT OPENS AT LEAST FIVE FEET

Increase UP travel. Turn the UP LIMIT adjustment screw clockwise. One turn equals 2" of travel.

If door does not open at least 5 feet: adjust UP (OPEN) FORCE as explained in Step 2.

IF DOOR DOES NOT CLOSE COMPLETELY

Increase DOWN travel. Turn down limit adjustment screw counterclockwise. One turn equals 2" of travel.

If the door still will not close completely, the header bracket is positioned too high. See Step 1, page 10.

IF ONE-PIECE DOOR DOES NOT CLOSE COMPLETELY

Increase DOWN travel. Turn down limit adjustment screw counterclockwise. One turn equals 2 inches of travel.

IF OPENER REVERSES IN FULLY CLOSED POSITION.

Decrease DOWN travel. Turn down limit adjustment screw clockwise. One turn equals 2 inches of travel.

IF DOOR REVERSES WHEN CLOSING AND THERE IS NO INTERFERENCE TO TRAVEL CYCLE

Test door for binding: Pull manual release handle. Manually open and close door. If door is binding, call a door serviceman. If door is not binding or unbalanced, adjust DOWN (CLOSE) FORCE. See Step 2.

ADJUSTMENT STEP 2

Adjust Force



DO NOT USE FORCE ADJUSTMENTS TO COMPENSATE FOR A BINDING OR STICKING GARAGE DOOR EXCESSIVE FORCE WILL INTERFERE WITH THE PROPER OPERATION OF THE SAFETY REVERSE SYSTEM OR DAMAGE THE GARAGE DOOR.

Force Adjustment Controls are located on rear panel of opener. **FORCE ADJUSTMENT** settings regulate amount of the power required to open and close door.

NOTE: The door STOPS in the UP direction if anything interferes with its travel. Door REVERSES in the DOWN direction if anything interferes with its travel (including binding or unbalanced doors).

If the force adjustments are set too light, door travel may be interrupted by nuisance reversals in DOWN direction and stops in UP direction. Weather conditions can affect the door movement, so occasional adjustment may be needed.

Maximum force adjustment range is 260 degrees, about 3/4 of a complete turn. Do not force controls beyond that point. Turn force adjustment controls with a screwdriver.

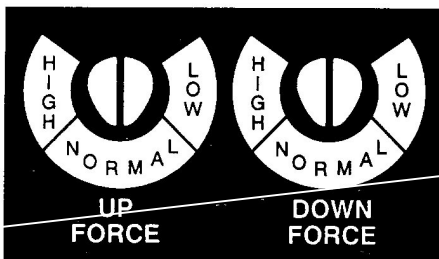
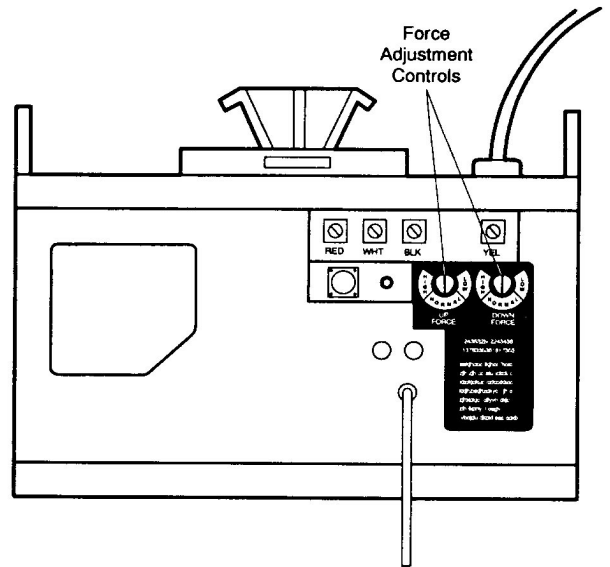

Adjustment Label

FORCE ADJUSTMENT CHART

TEST DOWN (CLOSE) FORCE

Grasp the door handle or door bottom when door is about halfway through DOWN (CLOSE) TRAVEL. Door should reverse. If the door is hard to hold or doesn't reverse, decrease DOWN (CLOSE) FORCE by turning the control in a counterclockwise direction. Make 10 degree turn adjustments until door reverses normally. After each adjustment, run opener through a complete cycle.

PROCEED TO STEP 3

IF DOOR DOESN'T OPEN AT LEAST 5 FEET

Increase UP (OPEN) FORCE by turning the control in a clockwise direction. Make 10 degree turn adjustments until door opens completely. Readjust UP LIMIT if necessary. After each adjustment, run opener through a complete travel cycle.

IF DOOR REVERSES DURING DOWN (CLOSE) CYCLE

Increase DOWN (CLOSE) FORCE by turning control clockwise. Make 10 degree turn adjustments until door completes close cycle. After each adjustment, run the opener through a complete travel cycle.

ADJUSTMENT STEP 3

Test Safety Reverse System

PROCEDURE: Place a one-inch obstacle on the floor under the garage door. Operate door in DOWN direction. The door **MUST** reverse on the obstruction.

If the door **STOPS** on the obstruction, it is not traveling far enough in the DOWN direction. Increase the DOWN limit by turning DOWN limit adjustment screw counterclockwise 1/4 turn. **REPEAT TEST.**

NOTE: Make sure limit adjustments do not force the door arm beyond a straight up and down position. See the illustration on Page 18/19.

When the door reverses on the one-inch obstacle, remove the obstruction and run the opener through a complete travel cycle.

Door MUST NOT reverse in closed position. Repeat Adjustment Steps 1, 2 and 3 if necessary.

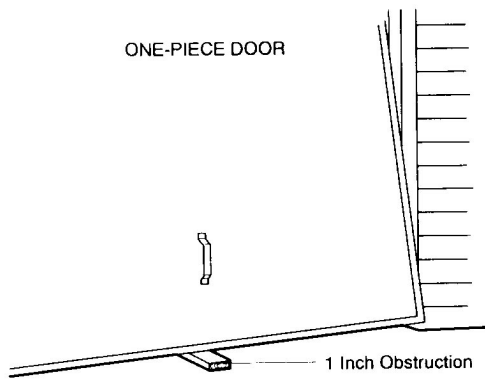

THE SAFETY REVERSE SYSTEM TEST IS IMPORTANT. GARAGE DOOR MUST REVERSE ON CONTACT WITH A ONE-INCH OBSTACLE PLACED ON THE FLOOR. FAILURE TO PROPERLY ADJUST OPENER MAY RESULT IN SERIOUS PERSONAL INJURY FROM A CLOSING GARAGE DOOR. REPEAT TEST ONCE A MONTH AND ADJUST AS NEEDED.

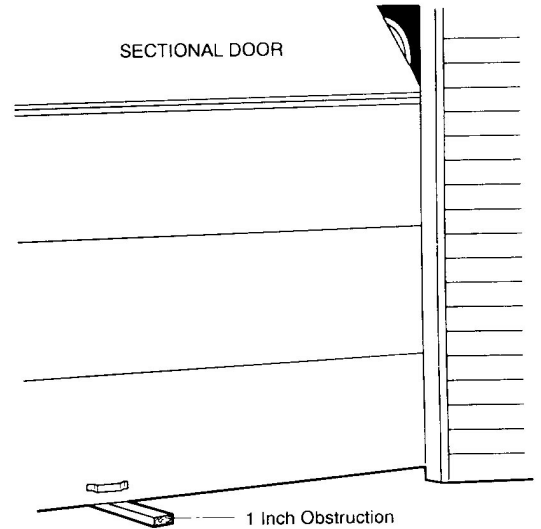

REPEAT ADJUSTMENT STEP 3 AFTER:

- EACH ADJUSTMENT OF DOOR ARM LENGTH, CLOSE FORCE OR DOWN LIMIT.
- ANY REPAIR OR ADJUSTMENT OF GARAGE DOOR (INCLUDING SPRINGS AND HARDWARE).
- ANY REPAIR OR BUCKLING OF THE GARAGE FLOOR R.
- ANY REPAIR OR ADJUSTMENT OF THE GARAGE DOOR OPENER.

THE PROTECTOR SYSTEM™

Installation of Optional Safety Feature

After opener has been installed and adjusted, **THE PROTECTOR SYSTEM** accessory can be installed.

Instructions are included with this optional device.

THE PROTECTOR SYSTEM PROVIDES AN ADDITIONAL MEASURE OF SAFETY AGAINST A SMALL CHILD BEING CAUGHT UNDER A GARAGE DOOR. It uses an invisible beam which, when broken by an obstruction, causes a closing door to open and prevents an open door from closing. **STRONGLY RECOMMENDED FOR HOMEOWNERS WITH YOUNG CHILDREN.**

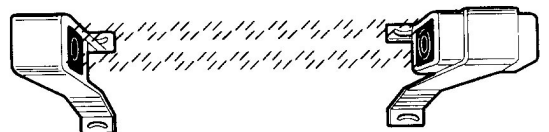

Radio Controls

F.C.C. rules prohibit adjustments to or modification of receiver and/or remote control transmitter circuitry except for changing the code setting and replacing the remote control transmitter battery. THERE ARE NO USER SERVICEABLE PARTS .
 Manufactured under 1 or more of the following U.S. patents: RE29,525; 4,037,201; 4,750,118; 4,806,930
 Other Patents Pending



ACTIVATE THE OPENER ONLY WHEN DOOR IS IN FULL VIEW, FREE OF OBSTRUCTION AND PROPERLY ADJUSTED . NO ONE SHOULD ENTER OR LEAVE GARAGE WHILE DOOR IS IN MOTION. DO NOT ALLOW CHILDREN TO OPERATE REMOTES OR DOOR CONTROL BUTTONS. DO NOT ALLOW CHILDREN TO PLAY NEAR THE DOOR.

Your garage door opener receiver and remote control transmitter have been set at the factory to a matching code. If you want to **CHANGE** your code or purchase additional remotes, follow the Instructions below. The code in any **NEW** remote control must be set to match the code in the original remote control.

MATCH/CHANGE THE CODE IN REMOTE CONTROL(S)

SET CODE SWITCHES IN ALL REMOTES TO MATCHING POSITIONS

PROCEDURE: Slide battery compartment cover back to access the code switches in your single function remote control and any new remote control

Place remote controls side by side as shown and set code switches in ALL remotes to matching positions (+, -, 0). Use a pen or screwdriver to slide the switches.

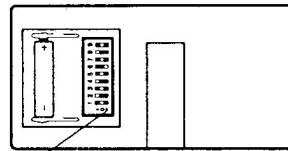
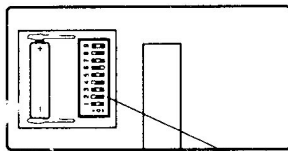

Remote Control Code Switches

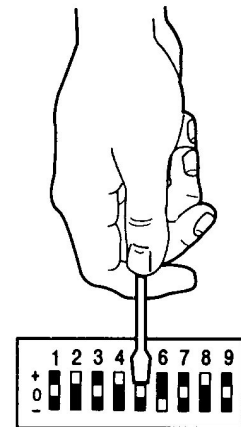

NOTE: Instructions for matching the code switches in two-channel and multi-function remote control transmitters are included with those accessories.

MATCH/CHANGE THE CODE IN THE RECEIVER

GARAGE DOOR OPENERS

WITH RECEIVER SMART CODE BUTTON

1. Press the RECEIVER Smart Button on the back panel of the opener as shown. The adjacent indicator light will turn ON.

CAUTION: Door will begin to move immediately if any transmitter has been activated.

If this occurs, wait until the door has completed its UP or DOWN cycle. Then begin again at Step 3.

2. STAND AWAY FROM THE DOOR and press the remote control transmitter push button. The indicator light will turn OFF and the door will move. Receiver and remote control(s) codes now match. The opener will operate when either the door control button or the remote control transmitter push button is pressed

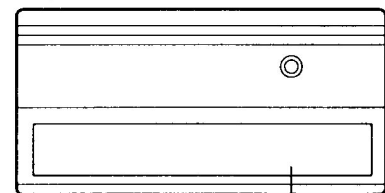

REMOTE CONTROL TRANSMITTER

Push Button

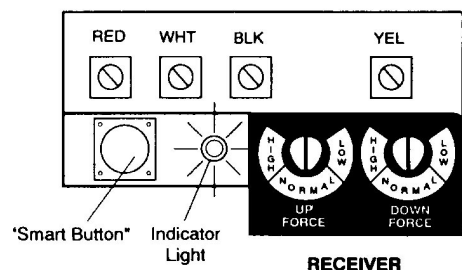

RECEIVER

NOTE: If the remote control transmitter push button is not pressed within 30 seconds, the indicator light will turn OFF. In that case, begin again at Step 1.

RAIL ASSEMBLY PARTS LIST

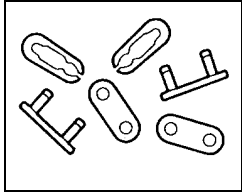

1 Master Link Kit
1A995

Inner Trolley w/Rod
41B3243

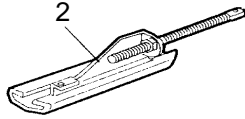

Chain 3
Pulley Bracket
41A2780

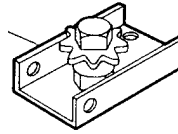

Full Chain Assy.
41D384

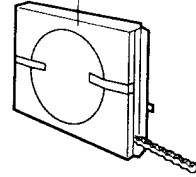

Outer Trolley
41B3244

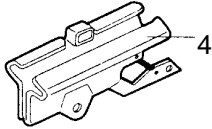

5 One-Piece
T-Rail
183B99

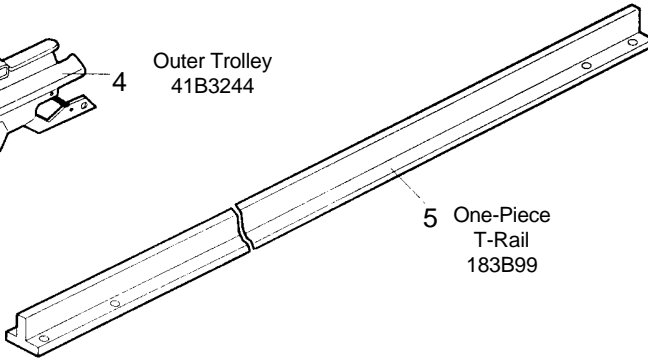

7

NOT SHOWN
Owners Manual
114A1225

INSTALLATION PARTS LIST



8
Straight Door
Arm Section
178B34

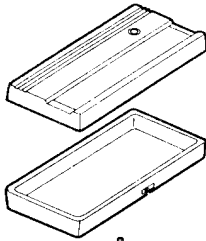

9
Remote Control
Transmitter
Case, Cover & Screw Assembly
(circuit board not included)
41A3593

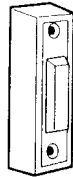

10 Lighted Push
Button Assembly
41A2756

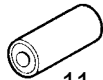

11
12V Battery
10A14



12
2 Strand
Bell Wire
217A238

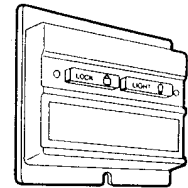

13 Multi-Function
Control Panel
41A3586

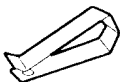

14
Remote Control
Transmitter
Visor Clip
29C128



15
Curved Door
Arm Section
178B35

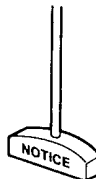

16
Emergency Rope
& Handle Assembly
41A2828

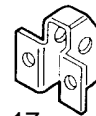

17
Door Bracket
12B374

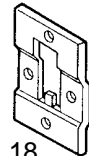

18
Door Bracket
Plate 12B380

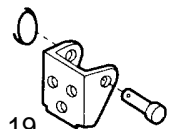

19
Header Bracket Plus
Clevis and Fastener
41A2829

Repair Parts

Chassis Assembly Parts List

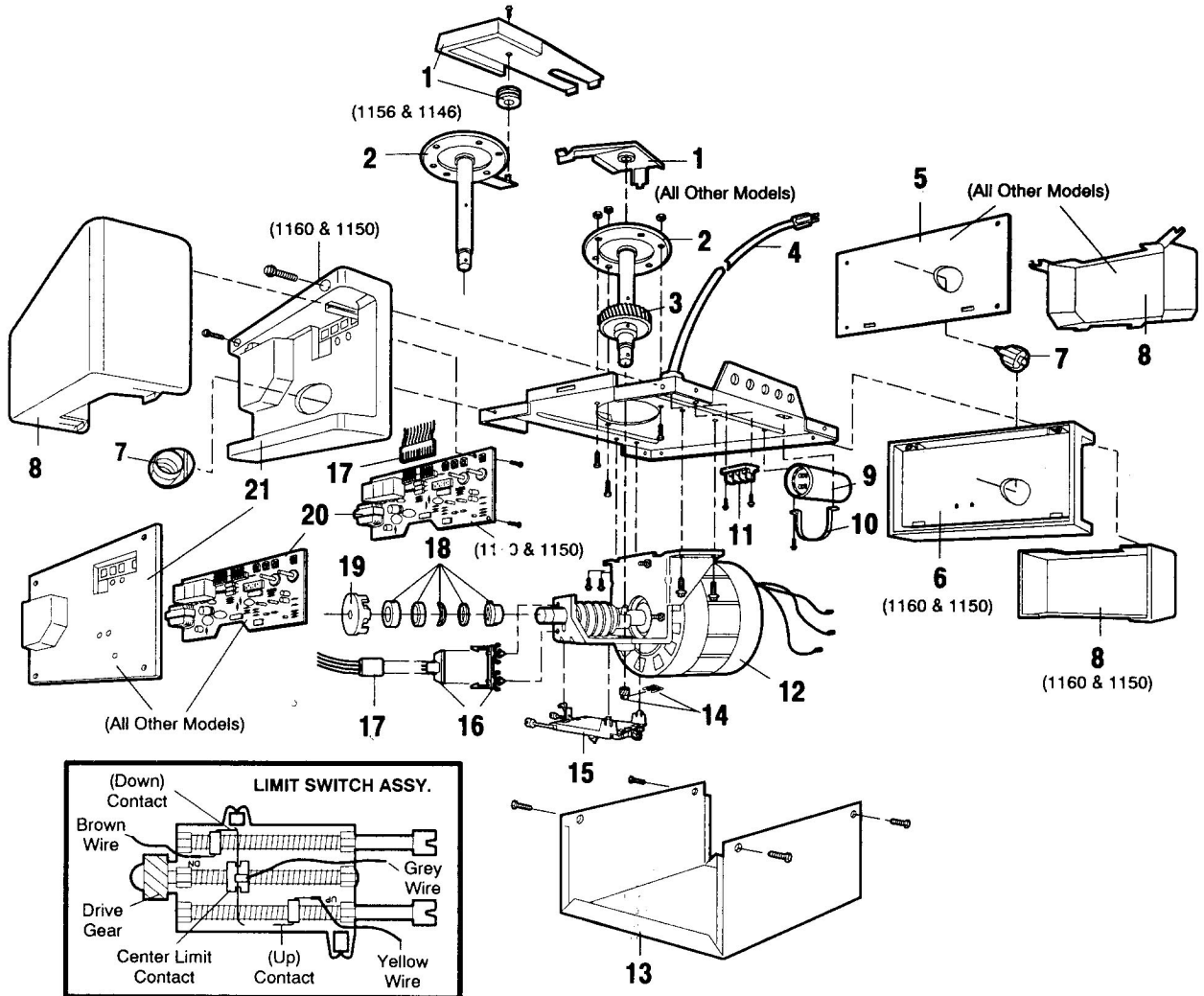

KEY PART NO.	KEY PART NO.	DESCRIPTION	KEY PART NO.	KEY PART NO.	DESCRIPTION
1	41A3260	Sprocket cover with screw and idler pulley (1156, 1146)	12	41D3058	Universal replacement motor & bracket assy. Complete with: Motor, worm, bracket, bearing assembly RPM sensor
	31C290	Sproket cover (1160, 1155, 1145, 1140)	13	41A3583-2	Cover (1160, 1156, 1155)
2	41A3261	Gear and sprocket assy. (1156, 1146)	14	41A3583-1	Cover (1150, 1146, 1145)
	41A2827	Gear and sprocket assy. (All other models)	15	41A3583	Cover (1140)
		Complete with:	16	41A2818	Helical gear 8 retainer w/grease
		Spring washer	17	41D3452	Limit switch assembly
		Thrust washer	18	41C3005	RPM sensor assembly
		Retaining ring	19	41C2726	Wire harness assy. w/plug
		Bearing plate	20	41A2826	Shaft bearing kit
		Roll pins (2)		41A2822	Interrupter cup assy.
		Drive gear and Worm gear		41A3626	Receiver Logic Board assy. (1160, 1150)
3	41A2817	Drive/worm gear kit w/grease		41A3627	Receiver logic board assy. (All other models)
4	41B2991	Line cord			Complete with:
5	143D100	End panel w/all labels			Logic board
6	143D110	End panel w/all labels (1160, 1150)			End panel w/all labels
7	175B88	Light socket			Light socket (1160, 1150 only)
8	108D36	Lens	21	41A3673	End panel w/all labels (1160, 1150)
	108D34	Lens (1160, 1150)		41A3712	End panel w/all labels (All other models)
9	30B363	Capacitor- 1/2 h.p.		41A2825	NOT SHOWN Chassis assy. hardware kit (includes screws not designated by a number in illustration)
	30B387	Capacitor- 1/3 h.p.			
	30B366	Capacitor- 1/4 h.p.			
10	12A373	Capacitor bracket			
11	41D3150	Terminal block w/screws			

LIFT-MASTER SERVICE IS ON CALL

OUR LARGE SERVICE ORGANIZATION
SPANS AMERICA

INSTALLATION AND SERVICE INFORMATION IS AS
NEAR AS YOUR TELEPHONE SIX DAYS A WEEK.
SIMPLY DIAL OUR TOLL FREE NUMBER:

1-800-528-6563

HOURS: 7:00 a.m. TO 3:30 p.m.
(Mountain Std. Time)
MONDAY through SATURDAY

For professional installation, parts and service, contact your local LIFT-MASTER/CHAMBERLAIN dealer. Look for him in the Yellow Pages, or call our Service number for a list of dealers in your area.

HOW TO ORDER REPAIR PARTS

Selling prices will be furnished on request or parts will be shipped at prevailing prices and you will be billed accordingly.

WHEN ORDERING REPAIR PARTS, ALWAYS GIVE THE
FOLLOWING INFORMATION

- PART NUMBER
- PART NAME
- MODEL NUMBER

ADDRESS ORDERS TO:
THE CHAMBERLAIN GROUP, INC.
Parts and Service Department
2106 N. Forbes Boulevard
Tucson, AZ. 85745

SERVICE INFORMATION
TOLL FREE NUMBER:
1-800-528-6563

LIFT-MASTER GARAGE DOOR OPENER ONE-YEAR LIMITED WARRANTY

The Chamberlain/Lift-Master warrants to the first retail purchaser of this product that it will be free from any defect in materials and/or workmanship for a period of twelve full months from the date of purchase. The product must be used in complete accordance with Lift-Master's instructions for installation, operation and care.

LIMITED WARRANTY ON MOTOR

Model 1160: The motor is warranted to be free from any defect in materials and/or workmanship for a period of 60 full months (5 years) from the date of purchase.

Models 1156, 1155: The motor is warranted to be free from any defect in materials and/or workmanship for a period of 48 full months (4 years) from the date of purchase.

Model 1150: The motor is warranted to be free from any defect in materials and/or workmanship for a period of 36 full months (3 years) from the date of purchase.

Models 1146, 1145: The motor is warranted to be free from any defect in materials and/or workmanship for a period of 24 full months (2 years) from the date of purchase.

This warranty does not cover non-defect damage, damage caused by unreasonable use (including abuse, failure to provide reasonable and necessary maintenance, or any alterations to the product), labor charges for dismantling or reinstalling of a repaired or replaced unit or replacement batteries.

If, during the warranty period, the product appears as though it may be defective **CALL OUR TOLL FREE SERVICE NUMBER BEFORE DISMANTLING IT (1-800-528-6563)**. If the product is then alleged to be defective please send it pre-paid and insured to our Service Center to obtain warranty repair. You will be advised of shipping instructions when you call the number listed above.

Please be sure to include a brief description of the problem and a dated proof-of-purchase receipt with any product that is returned for warranty repair.

Product under warranty, which upon receipt by Chamberlain/Lift-Master is determined to be defective in materials and/or workmanship, will be repaired or replaced (Chamberlain's option) at no cost to you and returned pre-paid. Defective parts will be repaired or replaced with new or factory rebuilt parts at Chamberlain's option.

THE DURATION OF IMPLIED WARRANTIES OF MERCHANTABILITY AND FITNESS FOR A PARTICULAR PURPOSE IS LIMITED TO THE DURATION OF THIS WRITTEN WARRANTY. SOME STATES MAY NOT ALLOW LIMITATIONS ON HOW LONG AN IMPLIED WARRANTY LASTS, SO THE ABOVE LIMITATION MAY NOT APPLY TO YOU.

All claims for consequential or incidental damages for breach of this warranty are excluded and in no event shall manufacturer's liability for breach of warranty, negligence, strict liability or breach of contract exceed the cost of the product covered herein, but the purchaser is entitled to the remedies expressly provided in this policy. Some states do not allow the exclusion or limitation of incidental or consequential damages, so the above limitation or exclusion may not apply to you.

No representative or person is authorized to assume for us any other liability in connection with the sale of this product. This warranty gives you specific legal rights, and you may also have other rights which may vary from state to state.