



**PREPROGRAMMED
REMOTES
INCLUDED
FOR QUICK
& EASY
INSTALLS**

BELT/CHAIN DRIVE

GARAGE DOOR OPENER MODELS

**ReliaG® 650 &
ReliaG® 850**

**OPERATION &
MAINTENANCE
MANUAL**



Includes INTELLICODE® Remote Control. Safe-T-Beam® System must be installed to close the door.
For use only with residential sectional overhead garage doors.

Homelink® and Car2U® compatible.



**Need help or have questions?
DO NOT RETURN to the store.**
For answers and assistance, visit www.geniecompany.com
or call Genie: 1-800-354-3643

**INSTALLER: LEAVE THIS MANUAL WITH HOMEOWNER
HOMEOWNER: SAVE THIS MANUAL FOR FUTURE REFERENCE**

WARNING

To reduce the risk of injury to persons or damage to property—Use this opener only with a residential sectional door.

Genie, Genie Logo, Intellicode, Safe-T-Beam, ReliaG, IntelliG, PowerMax, PowerLift, ChainMax, SilentMax, and Excelsior II, are registered trademarks. TriloG and GPower are trademarks of GMI Holdings, Inc., d/b/a The Genie Company. HomeLink is a registered trademark of Johnson Controls Technology Company. Car2U is a registered trademark of Lear Corporation. ©The Genie Company 2013. 08/2013

38484502355

TRANSMITTER COMPLIANCE STATEMENT

Transmitters comply with all United States and Canadian legal requirements as of the date of manufacture. No warranty is made that they comply with all legal requirements of any other jurisdiction. If transmitters are to be used in another country, the importer must determine compliance with any local laws and regulations which may differ from United States and Canadian requirements prior to use.

Los transmisores cumplen con todas las reglamentaciones legales de los Estados Unidos y del Canadá, en la fecha de fabricación. Ninguna garantía se da que cumplan con todas las reglamentaciones legales de ninguna otra jurisdicción. Si los transmisores se van a utilizar en otro país, el importador debe determinar si cumplen con las reglamentaciones y leyes locales que puedan ser diferentes a las reglamentaciones de los Estados Unidos y del Canadá, antes de usar los mismos.

Les émetteurs sont conformes à la réglementation américaine et canadienne à compter de leur date de fabrication. Aucune garantie n'est stipulée indiquant qu'ils sont conformes à toutes les prescriptions juridiques d'autres autorités. Si les émetteurs sont utilisés dans d'autres pays, il incombe à l'importateur d'en déterminer leur conformité aux lois et règles locales pouvant différer de celles des États-Unis et du Canada avant toute utilisation desdits émetteurs.

Sendegeräte entsprechen allen gesetzlichen Bestimmungen in den USA und Kanada zum Zeitpunkt der Herstellung. Wir übernehmen keine Gewährleistung für die Einhaltung aller gesetzlichen Bestimmungen in anderen Ländern. Sollen Sendegeräte in anderen Ländern eingesetzt werden, so muss der Importeur vor dem Gebrauch sicherstellen, dass die Sendegeräte auch solchen lokalen Bestimmungen entsprechen, welche von den Bestimmungen der USA und Kanadas abweichen.

截止于制造日期,传动装置符合美国和加拿大的所有法律要求。不提供传动装置符合任何其他司法地区所有法律要求之担保。如果传动装置需在任何其他国家使用,进口商必须在使用之前确定装置符合与美国和加拿大要求不同之所有地方法规条例。

截止于制造日期,传动装置符合美国和加拿大的所有法律要求。不提供传动装置符合任何其他司法地区所有法律要求之担保。如果传动装置需在任何其他国家使用,进口商必须在使用之前确定装置符合与美国和加拿大要求不同之所有地方法规条例。

截止于制造日期,传动装置符合美国和加拿大的所有法律要求。不提供传动装置符合任何其他司法地区所有法律要求之担保。如果传动装置需在任何其他国家使用,进口商必须在使用之前确定装置符合与美国和加拿大要求不同之所有地方法规条例。

 If you are a Home Owner/End User and need help or have questions: call 800-354-3643.

Table of Contents

1	Safety Information	
	Safety Notifications	3
	Important Safety Instructions.....	3
	Important Installation Instructions.....	3
2	Features	
	Safety	4
	Opener	4
	Infrared Protection Function	4
3	Programming Information	
	Required Wall Console Installation	5
	Series II Wall Consoles with White Buttons	5
	Introduction.....	6
	Overview of Powerhead Controls.....	6
	Travel Limits.....	7-8
	Closing Garage Door (DOWN Limit)	7
	Opening Garage Door (UP Limit)	8
	Force Control	9
	Contact Reverse Test.....	9
	Contact Reverse Adjustment	9
	Remote Control Programming.....	10
4	Optional Programming	
	Clearing Memory for Remotes.....	11
5	Maintenance and Adjustments	
	Important Safety Instructions	12
	Regular Maintenance	12-13
	Corrective Maintenance.....	13
	Adjustment Guide.....	14
	Locating Safe-T-Beam®.....	15
6	Wiring Diagram	15
7	Troubleshooting	16-17
8	Warranty	18
9	Accessories	19

SAVE THESE INSTRUCTIONS

READ AND FOLLOW ALL INSTRUCTIONS

1 Safety Information

OVERVIEW OF POTENTIAL HAZARDS READ THIS SAFETY INFORMATION

Garage doors are large, heavy objects that move with the help of springs under high tension and electric motors. Since moving objects, springs under tension, and electric motors can cause injuries, your safety and the safety of others depend on you reading the information in this manual. If you have questions or do not understand the information presented, call your nearest trained door system technician or visit our website at www.geniecompany.com

CONVENTIONS USED IN THESE INSTRUCTIONS

The following safety alert symbol and signal words are used throughout this manual to call attention to and identify different levels of hazard and special instructions.



This is the safety alert symbol. This symbol alerts you to potential hazards that can kill or hurt you and others.

All safety messages will follow the safety alert symbol and the word "DANGER", "WARNING", or "CAUTION".

- **DANGER** indicates an imminently hazardous situation which, if NOT avoided, will result in death or serious injury.
- **WARNING** indicates a potentially hazardous situation which, if NOT avoided, could result in death or serious injury.
- **CAUTION** indicates a potentially hazardous situation which, if NOT avoided, may result in injury or property damage.
- The word **NOTE** is used to indicate important steps to be followed or important considerations.

IMPORTANT SAFETY INSTRUCTIONS

Potential Hazard	Effect	Prevention
	WARNING Could result in Death or Serious Injury	Keep people clear of opening while door is moving. DO NOT allow children to play with the door opener. DO NOT operate a door that jams or one that has a broken spring.
	WARNING Could result in Death or Serious Injury	Turn OFF power before removing opener cover. When replacing cover, make sure wires are NOT pinched or near moving parts. Opener must be fully grounded.
	WARNING Could result in Death or Serious Injury	DO NOT try to remove, install, repair or adjust springs or anything to which door spring parts are fastened, such as, wood blocks, steel brackets, cables or other like items. Installations, repairs and adjustments must be done by a trained door system technician, using proper tools and instructions.

IMPORTANT INSTALLATION INSTRUCTIONS

WARNING

TO REDUCE THE RISK OF SEVERE INJURY OR DEATH

READ AND FOLLOW ALL SAFETY, INSTALLATION AND OPERATION INSTRUCTIONS. If you have any questions or do not understand an instruction, call The Genie® Company or your local Genie® Authorized Dealer.

- **DO NOT** install operator on an improperly balanced door. An improperly balanced door could cause severe injury. Repairs and adjustments to cables, spring assembly, and other hardware must be made by a trained service person using proper tools and instructions.
- Remove all ropes, and disable all locks connected to the door before installing operator.
- Where possible, install the door opener 7 feet or more above the floor. For products having an emergency release, mount the emergency release within reach, but at least 6 feet above the floor and avoiding contact with vehicles to avoid accidental release.
- **DO NOT** connect the operator to the source of power until instructed to do so.
- Locate the wall console button: A) Within sight of door. B) At a minimum height of 5 feet so small children cannot reach it. C) Away from all moving parts of the door.
- Install the entrapment **WARNING** label next to the wall button or console, in a prominent location. Install the emergency release handle on the emergency release cord.
- The operator must reverse when the door contacts a 1-1/2 inch high object on the floor at the center of the doorway. This is about the size of a 2" x 4" board laid flat.

2

Features

Begin here **ONLY AFTER** completing assembly and installation of the opener. Review the **Assembly and Installation poster** to ensure all steps have been performed.

Contact your Genie® Dealer for an installation poster, or if needed, visit www.geniecompany.com to download a PDF file.

SAFETY FEATURES



Safe-T-Beam® (STB) Non-Contact Reversing System

Puts an invisible beam across the door opening. The door stops and reverses to the full open position if anything passes through the beam. LED indicator lights on the powerhead and on the STBs provide a self-diagnostic code if an operational problem exists.

Safe-T-Reverse® Contact Reversing System

Automatically stops and reverses a closing door within two seconds of contact with an object.

Watch Dog™ Monitoring System

Monitors the Safe-T-Beam® system to ensure proper functionality and will automatically stop and reverse a closing door if a problem is detected.



Manual Emergency Release

Manually releases door from door opener. Used during a power failure or other emergency to allow manual opening and closing of door.



SmartSet™ Electronic Programming

Easily adjust the programming to set limits and program new remotes.



Automatic Lighting System

One bulb lighting system supplies light for safer evening exits and entries. Turns **ON** when door is activated and automatically turns **OFF** 4 minutes later.

INFRARED PROTECTION FUNCTION

1. The Safe-T-Beam® has no effect on the door during an opening cycle.
2. If the Safe-T-Beam® detects an obstruction when trying to close the door, it will not allow the door to close.
3. When the garage door is closing, if Safe-T-Beam® is interrupted by a person or obstacle, the garage door will stop its downward travel and reverse automatically to its fully opened position.
4. If the Safe-T-Beam® System fails, loses power, or is installed improperly, press and hold the wall console "open/close" button until the door reaches its fully closed position. If you release the "open/close" button on the wall console during the closing movement, the door will reverse automatically to its fully-opened position.

OPENER FEATURES



INTELLICODE®

An encryption system that enhances the security of the door opener by continuously changing the access code each time the remote is used. The door opener responds to each new code only once. An access code copied from a working system and tried again, will not control the door opener.



Wall Console (With selected models)

Operates door opener from inside garage. The wall console has an indicator light with: Open/Close, Sure-Lock™, and independent light control buttons.



Home Link® and Car2U® compatible. Refer to your motor vehicle manual or visit www.geniecompany.com for instructions.



PRE-PROGRAMMED REMOTE CONTROL

For ease and speed of installation, the remote included with this opener comes from the factory, pre-programmed. No additional steps are required to activate the door using the remote.



NOTE: This will only work after installation is complete and Travel Limits have been set.

NOTE: If your operator has not been, or will not be professionally installed.

- Use this manual **ONLY AFTER** completing assembly and installation of the opener.
- Review the Assembly/Installation Poster and check that all steps have been completed.

Contact your Genie® Dealer for an Assembly/Installation Instructions poster, if needed. You can also go to www.geniecompany.com to download a printable file.



3

Required Wall Control Installation

In your carton you will find one of the following wall controls.

NOTE: Wall consoles from other manufacturers may not work with these openers. Use only the wall console provided with this unit. See warning.

SERIES II WALL CONSOLE WITH WHITE BUTTONS

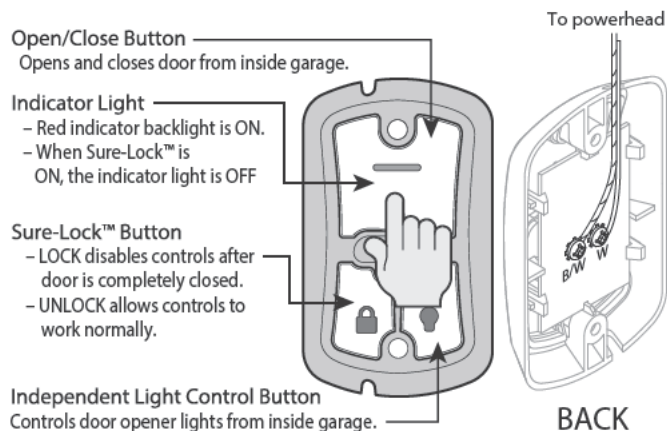

If you encounter a problem, check:

- White wire connected to terminal "W."
- Striped wire connected to terminal "B/W."

FEATURES

Indicator Light

Large white button will display Red when wall console is properly wired and Sure-Lock™ is OFF. When Sure-Lock™ is ON, this light is off.

Open/Close Button

Use this button to open or close garage door. When Sure-Lock™ is ON, the Open/Close button will CLOSE the door only.

NOTE: Constant button pressure in the CLOSE mode will override STB fault in the powerhead and close door.

Independent Light Control Button

Use this button to turn powerhead lights ON. Powerhead lighting will remain ON until this button is pressed again or a door action has been completed.

Sure-Lock™ Button

When Sure-Lock™ is ON, and the door is closed, the powerhead cannot be activated by the wall console or a remote.

- Press and release to activate Sure-Lock™ (red light goes off).
- Press and release to turn Sure-Lock™ OFF (red light goes on).

WALL BUTTON

This is a lighted wall button. Press once to move the door.

If the button is not lighted, check:

- White wire connected to terminal "W."
- Striped wire connected to terminal "B."

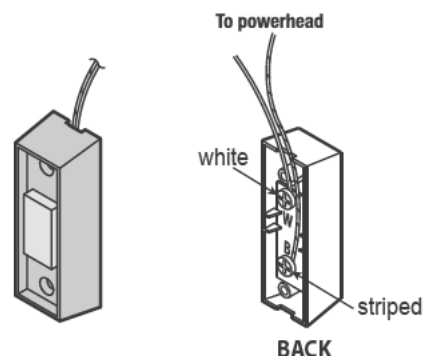

TIP: Powerhead Connections

FROM STBs FROM WALL CONSOLE OR BUTTON

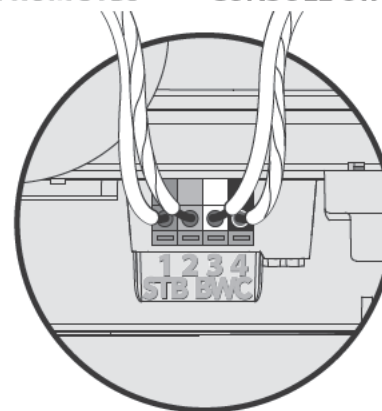

- TERMINAL #1 = BROWN
- TERMINAL #2 = ORANGE
- TERMINAL #3 = WHITE
- TERMINAL #4 = BLACK

⚠ WARNING

Use of any other wall control can cause unexpected operation of the door and loss of lighting feature. Locate wall console within sight of door and far enough from door to prevent contacting it while operating the control. Control must be at least 5 feet above floor to prevent small children from operating it.

3

Programming Overview

NOTE: Before you begin programming, check to make sure there are no objects in the garage door opening.

INTRODUCTION

Now that your Genie® garage door opener is installed, you will want to program the opener so that the door opens and closes properly and all remote devices operate correctly. The following steps guide you through setting your opener so it functions properly for you.

The following information will take you through programming your opener's functional settings for use.

OVERVIEW OF POWERHEAD CONTROLS

This section describes the programming functions on the powerhead of the opener. Use the following information to familiarize yourself with the buttons, LED indicators and products used to program functions.

Powerhead: There are 3 programming buttons and 2 LED lights on the powerhead. Each of the buttons is used to enter and complete the setup programming. The LED lights indicate status or a function change by illuminating ON, OFF, or ON FLASHING in one of three different colors: blue, red or purple.

There are 3 programs:

1. Door Travel Limits.
 - This program is used to set how far your door travels up and down.
2. Remote Programs (default menu)—only required for added remote control transmitters.
 - These show you how to program your remotes to synch with additional remote control devices, wall consoles, keypads and the powerhead.
3. Force Setting Program.
 - This program controls the force applied in during the closing and opening of your door. They are factory set and will rarely require adjustment only under certain circumstances.

NOTE: The 3 programming buttons are for programming ONLY. These buttons should NOT be used to operate the opener once the Required Programming section has been successfully completed.

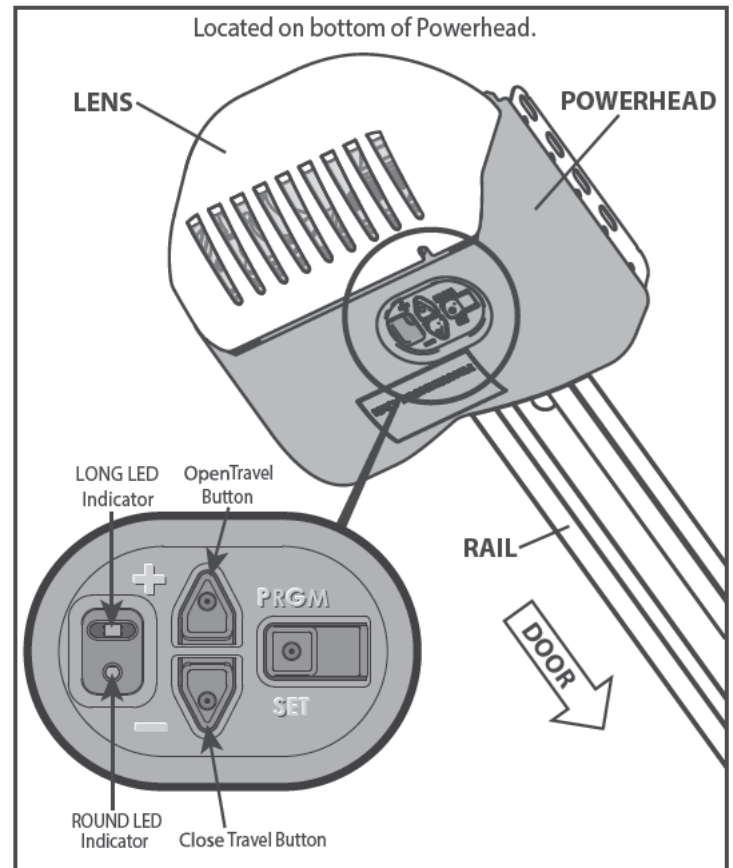
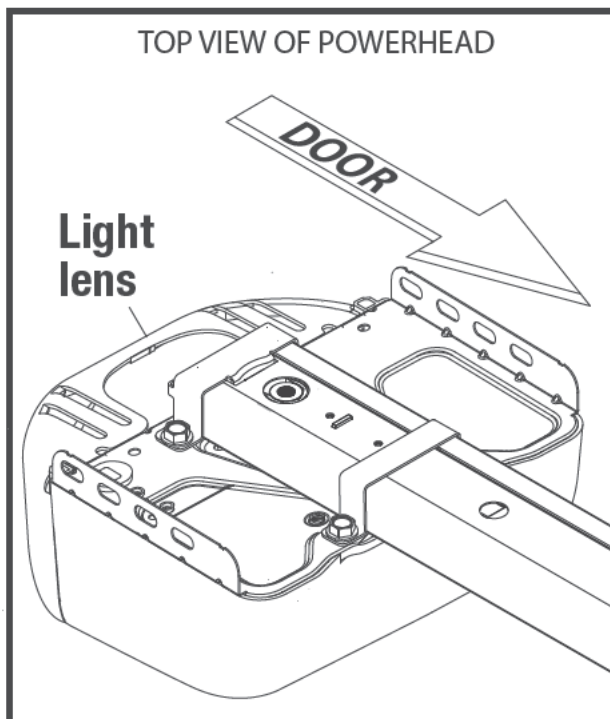

Enters into and selects programming menus.



Move door up or down during programming and advance through menus.

3

Programming Information

TRAVEL LIMITS

⚠ WARNING

- Make sure doorway is in view and clear of obstacles and people to avoid injury or damage to property.
- DO NOT operate this unit from wall console before **LIMITS** are set. Severe damage to the opener can occur.
- The shuttle **MUST** be engaged to carriage **BEFORE** setting limits. See Installation Poster (if provided) or call Customer Service at 1-800-35GENIE or visit www.geniecompany.com

NOTE: If bullet has **NOT** been engaged to carriage, do so now. See page 12.

NOTE: Before setting limits confirm wall console red indicator backlight is ON. If not illuminated, check for correct wiring or the Sure-Lock switch may be activated. (On selected units.)

ORIENTATION

Standing under the opener's powerhead - facing the door - looking up - this is the view you will see of the programming buttons and LEDs.

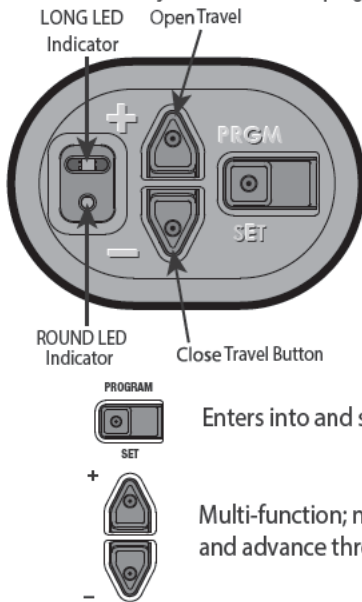

- Just remember—the pointed end of the button (like an arrowhead) points in the direction the carriage will move when that button is pushed.

NOTE: While setting limits, the powerhead has a **30 second time-out**. You have **30 seconds** to execute each step. If you see **two solid red or flashing LEDs on the Powerhead**, you have run out of time and must go back to the beginning of the step and start over. You can restart as many times as necessary to complete each step.

Closing Garage Door (Down Limit)

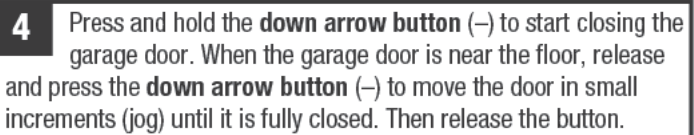
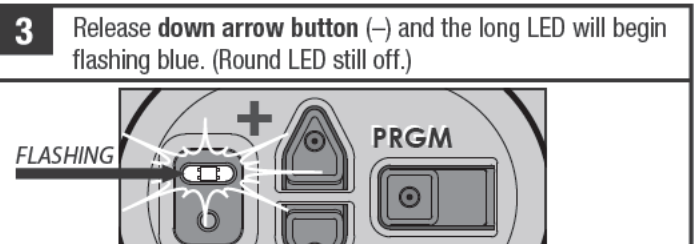
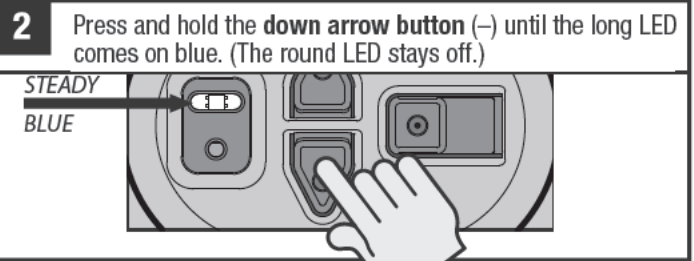
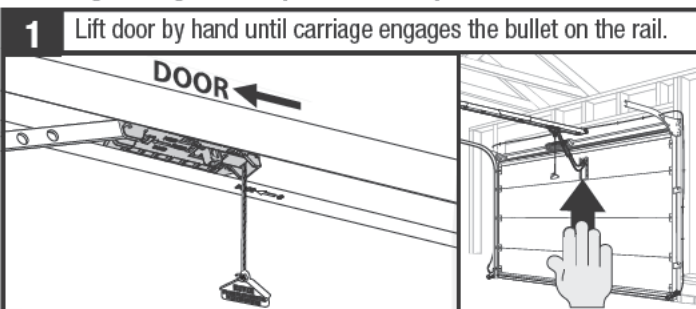

NOTE: You can start and stop garage door movement using either the down (-) or up (+) button until you door is in the correct limit position.

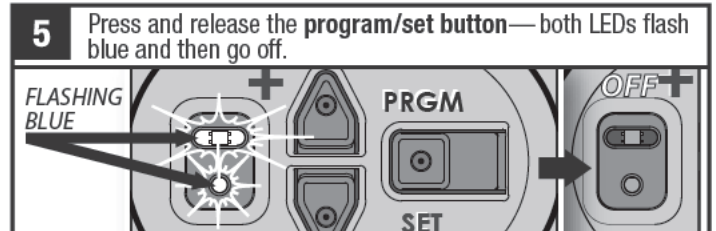

The DOWN (CLOSED) TRAVEL LIMIT IS NOW PROGRAMMED.

3

Programming Information

Opening Garage Door (Up Limit)

NOTE: Beginning with garage door closed is recommended but not necessary.

NOTE: While setting limits, the powerhead has a **30 second time-out**. You have **30 seconds** to execute each step. If you see **two solid red or flashing LEDs on the Powerhead**, you have run out of time and must go back to the beginning of the step and start over. You can restart as many times as necessary to complete each step.

- 6** Press and hold the **up arrow button (+)** until the long LED light comes on blue (round LED remains off).

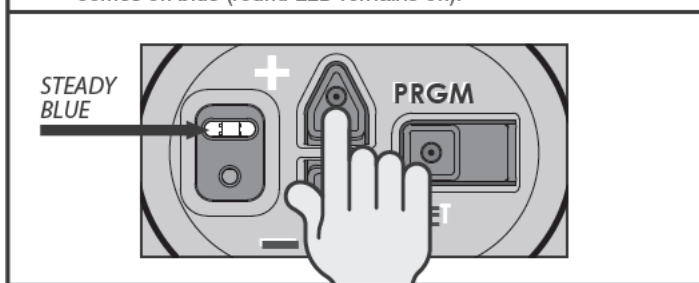

- 7** Release **up arrow button (+)** and the round LED will begin flashing blue. (The long LED will go off.)

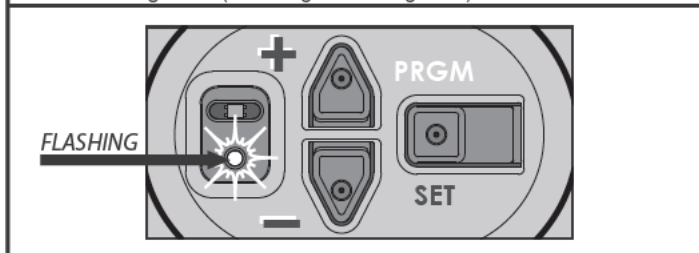

- 8** Press and hold the **up arrow button (+)** to start opening the garage door. When the garage door is about to clear its opening, release and press the **up arrow button (+)** to move the door in small increments until it is fully open. Then release the button. Ensure the carriage does not contact the powerhead—the red release cord must stay clear of the powerhead—the red release cord must stay clear of the powerhead (see page 12) to allow manual operation.

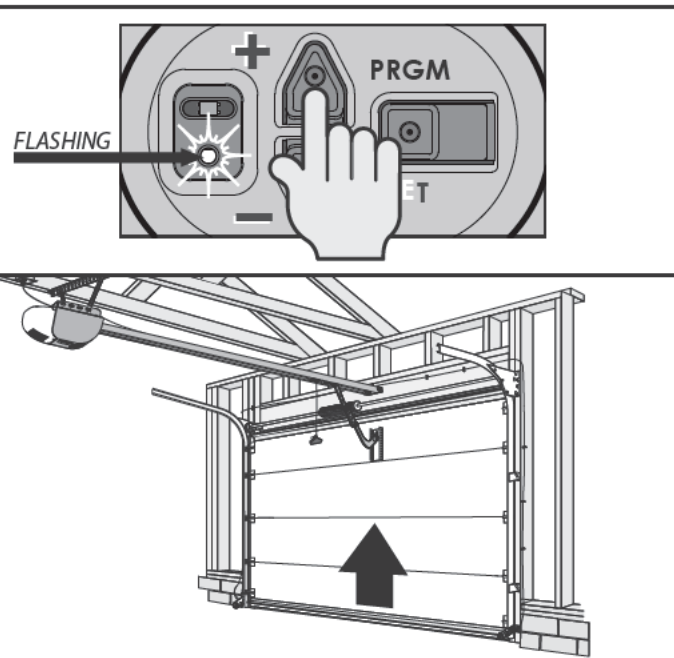

- 9** Press and release the **program/set button**—both LEDs flash blue and then go off. The UP (OPEN) TRAVEL LIMIT IS NOW PROGRAMMED.

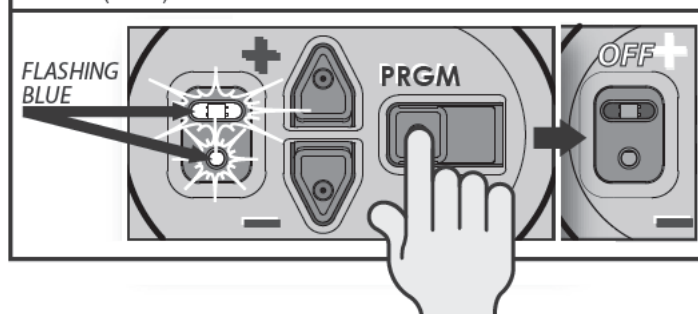

**The UP (open) limit is programmed.
BOTH DOOR LIMITS ARE NOW PROGRAMMED.**

3

Wall Control Operation

Force Control

The force controls are automatically set when you use the wall control for the first time with your garage door. The door **MUST** complete one full cycle, from full open to full close and then, full close to full open, before the settings are automatically recorded.

10. Press and release the wall control Open/Close button and allow your garage door to travel and stop at the down (closed) limit.

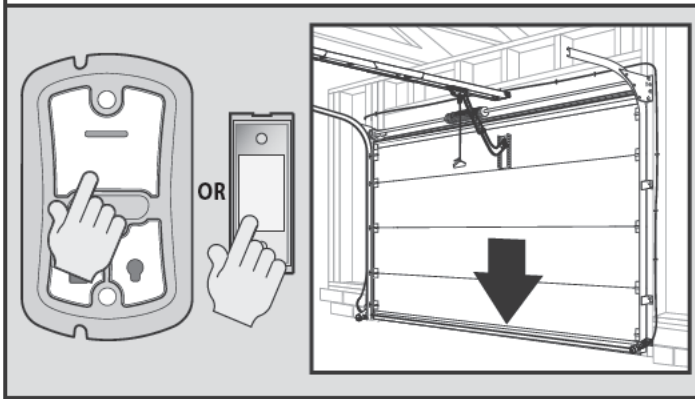

11. Press and release the wall control Open/Close button and allow your garage door to travel and stop at the up (open) limit.

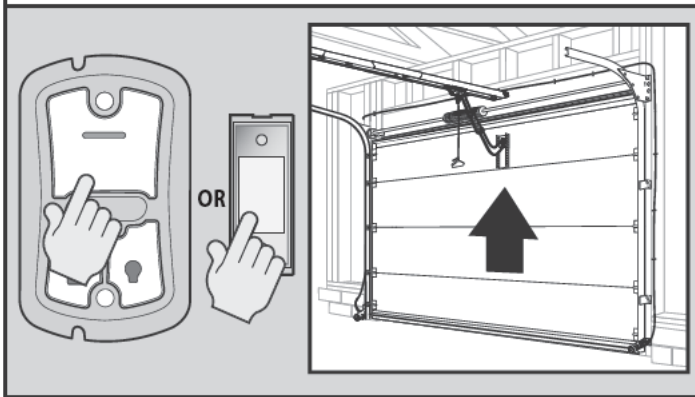

NOTE: Force controls **DO NOT** require programming. Force limits are factory set and rarely require adjustments. Making adjustments to these settings is covered in the “Maintenance and Adjustments” Section of this Manual (page 14).

FORCE CONTROL IS NOW SET.

Contact Reverse Test

NOTE: The Limit and Force settings **MUST BE COMPLETED** before performing the Contact Reverse Test.

1. With your garage door open, lay a 2" x 4" board flat on the floor at the center of the door opening.

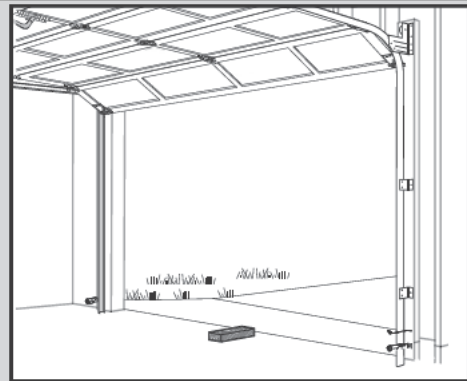

2. Close the garage door using the Open/Close button on the wall control.

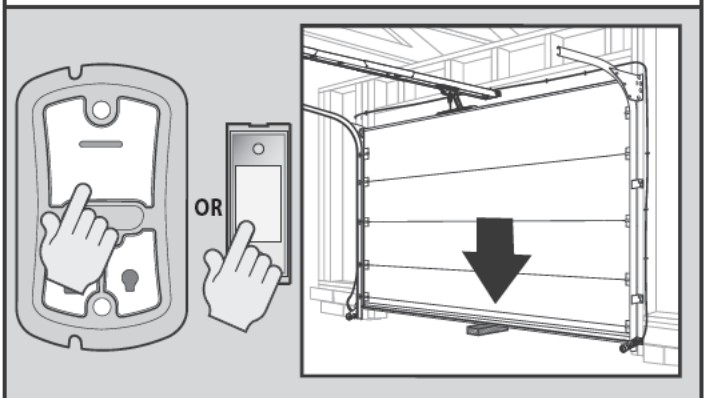

When the door contacts the board, it should stop and reverse direction within 2 seconds to the fully open position. Red LED lights on the powerhead will begin to flash with the reversal of the door. Remove the 2" x 4" board after a successful contact reversal test. The next cycle will clear the flashing red LEDs.

Contact Reverse Adjustment

If the door stops before contacting the board or if it does not reverse direction to fully open after contact with the board, it may be due to an improperly set DOWN limit. Verify settings by:

1. Repeat the “Down Travel Limit” section (page 8) to make certain the door is closing tight against the floor.
2. Repeat the “Force Control” section on the left to set force limits.
3. Repeat the “Contact Reverse Test” above.

Repeat this process as needed until the door passes the Contact Reverse Test. For further help, refer to the “Maintenance and Adjustment” section/Regular Maintenance, page 14.

3

Remote Control Programming

REMOTES

NOTE: THE REMOTE CONTROLS INCLUDED WITH THIS OPENER, HAVE BEEN PRE-PROGRAMMED AT THE FACTORY FOR YOUR CONVENIENCE.

NOTE: The following instructions are for remote control transmitters purchased separately in addition to those provided with this opener, but can also be used if any remote(s) may require re-programming.

NOTE: You have **30 seconds** to execute each step. If you see **two flashing red LEDs on the Powerhead**, you have run out of time and must go back to the beginning of the step and start over. You can restart as many times as necessary to complete each step.

NOTE: Do NOT hold Remote too close to the Powerhead when programming Remote buttons.

NOTE: Each button on each Remote must be programmed separately, following these steps.*

14 Remove protective film for battery from remote.

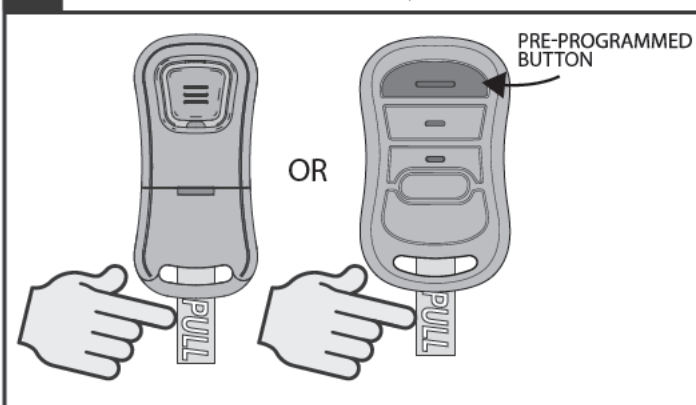

* If the remote came included with this opener, no further programming is required. Proceed to step 19.

15 Press and hold the Program-Set button (the round LED turns blue).

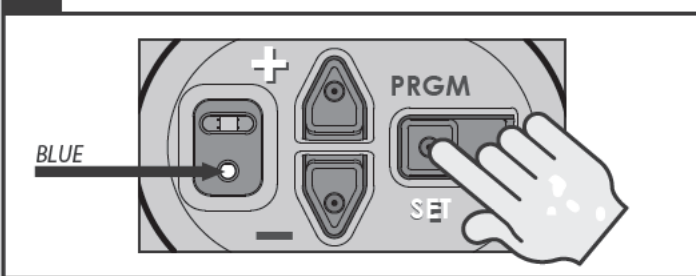

16 Release the Program-Set button (the long LED begins flashing purple).

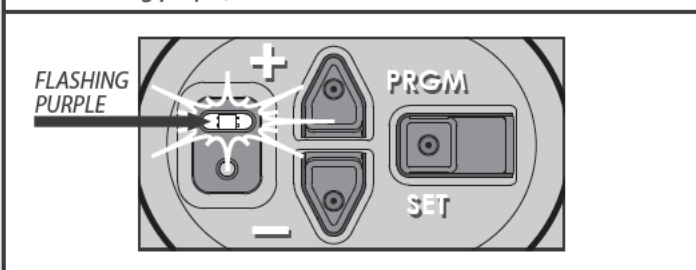

17 Press and release the Remote button (The long LED turns purple).

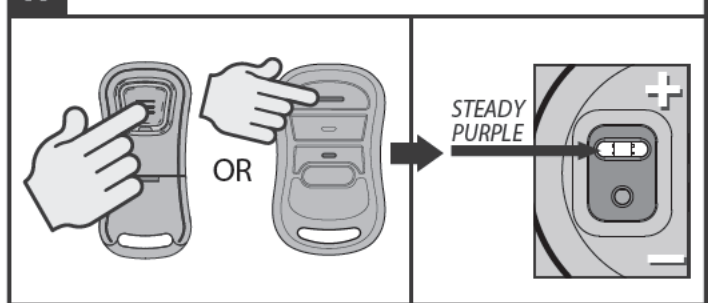

18 Press and release the remote button again (both LED's flash blue and then turn off).

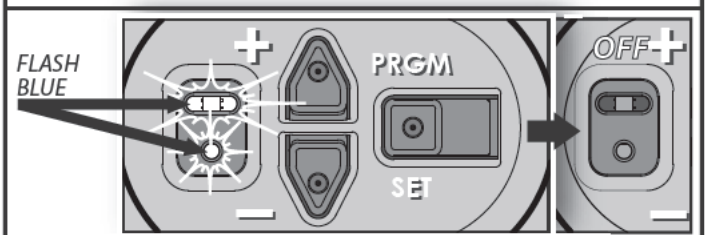
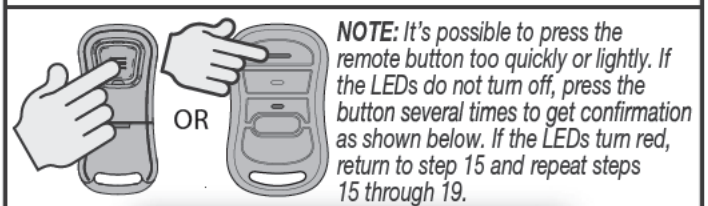

19 Press and release the remote button (the door should open or close).

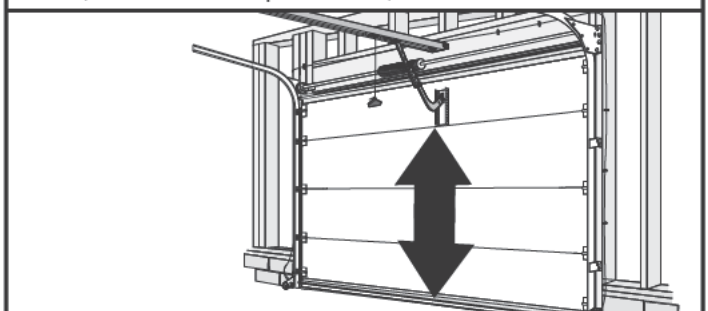

The Remote is now programmed.

Repeat as necessary for additional Remotes.

BASIC PROGRAMMING IS COMPLETE AND YOUR GARAGE DOOR IS READY TO USE!

NOTE: For Car2U and HomeLink, park the car outside the garage with the ignition key in the "Accessory" position. Follow the Car2U or HomeLink instruction included in your vehicle manual to set the button in the car to Genie® mode.

NOTE: Your older Intellicode® remote transmitters will operate this new model opener after programming, using the procedure on these pages.

4

Optional Programming

CLEARING MEMORY FOR REMOTES

1 Press the **Program Set button** on the powerhead until the round LED turns blue.

2 Release the **Program Set button**, round LED goes off and the long LED flashes purple.

3 Press **up arrow button (+)** and **down arrow button (-)** simultaneously on the powerhead until both LEDs flash blue and then turn off.

4 To verify the memory is cleared, use a remote that was previously programmed to the powerhead and press the button. The door should not move.

NOTE: The garage door opener will operate normally using the Wall Control.

NOTE: When the remote is pressed the round LED will flash blue but will not activate the door opener.

NOTE: Clearing Remotes from the Powerhead memory will clear ALL programmed Remotes and wireless Keypads. Your opener will no longer recognize any signal received from a missing Remote.

All remaining (or recovered) Remotes MUST BE reprogrammed as shown on page 10.

FCC and IC CERTIFIED

This device complies with FCC Part 15 and Industry Canada license exempt RSS standard(s). Operation is subject to the following two conditions: (1) this device may not cause interference, and (2) this device must accept any interference, including interference that may cause undesired operation of the device. This equipment generates, uses and can radiate radio frequency energy and, if not installed and used in accordance with the instructions, may cause harmful interference to radio communications. However, there is no guarantee that interference will not occur in a particular situation. If this equipment does cause harmful interference to radio or television reception, which may be determined by turning the equipment OFF and ON, the user is encouraged to try and correct the interference by one or more of the following measures: (a) Re-orient or relocate the receiver antenna, (b) Increase the separation between the opener and receiver, (c) Connect the opener into an outlet on a circuit different from that to which the receiver is connected, and (d) Consult your local dealer. Any modification or changes to this equipment which are not expressly approved by the manufacture could void the user's authority to operate the equipment.

This device complies with Health Canada's Safety Code. The installer of this device should ensure that the RF radiation is not emitted in excess of the Health Canada's requirement. Information can be acquired at:

<http://www.hc-sc.gc.ca/ewh-semt/radiation/cons/wifi/index-eng.php>

IMPORTANT SAFETY INSTRUCTIONS

⚠ WARNING

TO REDUCE THE RISK OF SEVERE INJURY OR DEATH, READ AND FOLLOW ALL INSTRUCTIONS.

- NEVER** let children operate or play with the door controls.
- Keep remote away from children.
- ALWAYS** keep the moving door in sight and away from people and objects until door is completely closed. **NO ONE SHOULD CROSS THE PATH OF THE MOVING DOOR.**
- NEVER GO UNDER A STOPPED, PARTIALLY OPEN DOOR.**
- Test opener monthly. The door **MUST** reverse on contact with a 1-1/2" high object (or a 2" x 4" board laid flat) at the center of doorway on the floor. After adjusting either the force or limit of travel, retest door opener. Failure to adjust the opener properly may cause severe injury or death.
- When possible, use emergency release **only** when door is closed. Use caution when using this release with the door open. Weak or broken springs are capable of increasing the rate of door closure and increasing the risk of severe injury or death.
- KEEP DOORS PROPERLY BALANCED.** See your garage door Owner's Manual. An improperly balanced door increases the risk of severe injury or death. Have a trained door system technician make repairs to cables, spring assemblies, and other hardware.

SAVE THESE INSTRUCTIONS

⚠ WARNING

- Garage door hardware (springs, cables, brackets, pulleys, etc.) are under extreme pressure and tension.
- DO NOT** attempt to repair or adjust door springs or any hardware, and **DO NOT OPERATE** garage door automatically or manually if door is improperly balance or springs are broken.
- CONTACT A TRAINED DOOR SYSTEM TECHNICIAN.**

REGULAR MAINTENANCE

Basic monthly maintenance tasks include:

- Contact Reverse
- Lubricate door hardware
- Safe-T-Beam® System Check
- Door balance

A. Contact Reverse Test

See page 9.

B. Lubricate door hardware

Inspect door rollers and hinges and lubricate as needed using a light weight general purpose grease.

B. Safe-T-Beam® (STB) System Check

Check that both the RED and GREEN LEDs are ON steady. This indicates the system is working properly. If both LEDs are not ON steady, check the appropriate items below:

- STB red LED flashes.
 - Check for obstruction.
 - Check alignment.
 - Verify wire routing from STBs to STB connection in powerhead
 - Check for signal interference from another Safe-T-Beam® unit (for multiple door installations).
- No STB red or green LED displayed.
 - Check wiring and wire connections.

If the system appears to be working properly, perform the check as follows:

- Start the door closing.
- Pass an object through the beam. The door should stop and reverse to the fully open position.

C. Door Balance (Spring Tension)

Perform the check as follows:

- With the door closed, pull manual emergency release handle **DOWN** and toward door and let go to disengage the carriage from the drive chain or belt (see illustration).

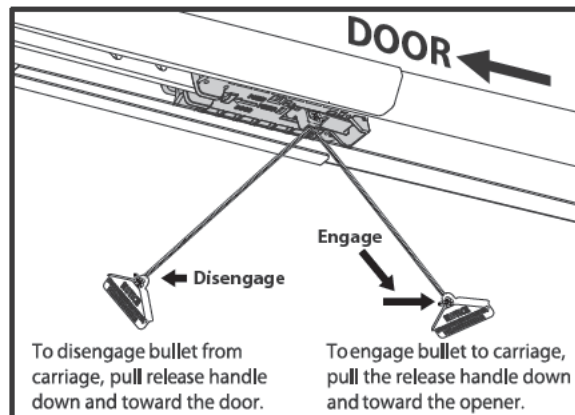

- Raise and lower the door manually—it should move freely and smoothly.
- Raise door manually about 3' to 4' feet and let go.



- Door should remain stationary or move very slowly.
- If door moves quickly, **CONTACT A TRAINED DOOR SYSTEM TECHNICIAN** to have your door springs serviced.
- Close the door.
- Place the carriage in the "engage" position (see illustration).
- Operate door using remote or wall control, The carriage will reattach itself to the drive chain/belt.

5

Maintenance and Adjustments

CORRECTIVE MAINTENANCE

Changing Light Bulbs



WARNING

- Use extreme caution when working from a ladder or step stool.
- When replacing light cover, make sure wires are not pinched or near moving parts.
- Use only properly rated incandescent, LED or CFL light bulbs.
- DO NOT use bulbs with a rating greater than 60 Watts.
- Use A19 size light bulbs. DO NOT use bulbs having a short neck.

1. Disconnect power to door opener.

- Open powerhead light cover by pressing down on upper locking tabs.

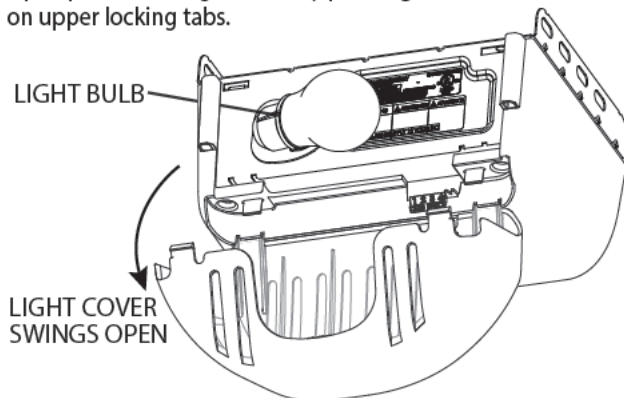

- Remove light bulb.
 - Replace light bulb.
 - Use 60 watt incandescent bulbs or the CFL or LED equivalent.
 - Close powerhead light cover.
- #### 2. Reconnect power to door opener.
- Test light operation.

Reset Open/Close Travel Limit

Performing all Travel Limit Settings steps (pages 7, 8 and 9) erases previous Travel Settings.

NOTE: The opener will not close the door automatically unless the Safe-T-Beam® System is installed and Limits are programmed.

Remote Battery Replacement (1-button)

Replace the remote battery with a CR2032 coin cell type battery.

1. Slide the battery cover off (it's the lower half of the remote's case) by pressing on the case just below the indentation at the top of the cover and sliding it down. *You may need to insert a coin into the indentation on the front of the case and pry to unlatch the battery cover in order to slide it off.*

2. Slide out the old battery and slide in the new. **Be sure it is positive side UP.**

3. Slide the battery cover on until it snaps into place.

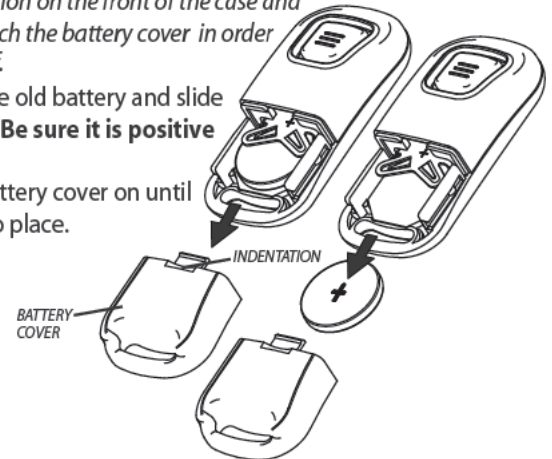

Remote Battery Replacement (3-button)

Replace remote battery with a CR 2032 coin cell battery.

1. Open remote case using a washer or coin that fits into the slot at top top of remote.
2. Replace battery.
3. Align components and snap case closed.

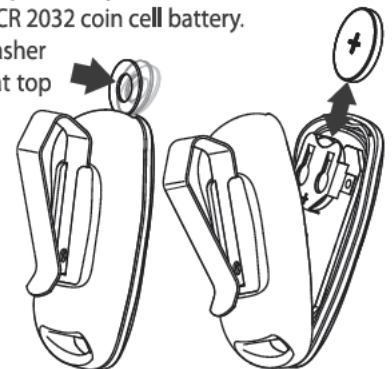

5

Maintenance and Adjustments

ADJUSTMENT GUIDES

CAUTION

Door closing force is **FACTORY** set and requires no adjustment for normal operation.

- **NEVER** adjust the force settings to compensate for damage, including an unbalanced door, binding door track, or broken spring.
- Perform monthly a **CONTACT REVERSE TEST**. See page 9.

Force Settings

Force settings are pre programmed at the factory and "learned" during the Open/Close Limit settings steps (see pages 7-8). For normal use, these settings should not need adjustment with this unit.

However, conditions possibly requiring adjustment are:

1. Doors with very stiff weather seals.
2. Doors that start down, STOP, and reverse before closing.
3. Doors that start up, but STOP before they completely open.

Force Adjustment

3 Press up arrow button (+) and down arrow (-) simultaneously on the powerhead until the round LED turns RED.

2 Release the arrow buttons

FLASHES BLUE 3 TIMES

THE CURRENT UP FORCE SETTINGS WILL DISPLAY.
See chart to right.

3 Press either arrow button until you reach the desired setting. (See chart at right.)

USE CHART.

4 Press and release the program button.

THIS LOCKS IN THE UP SETTING.
FLASHES BLUE

THE CURRENT DOWN FORCE SETTINGS WILL NOW DISPLAY.
USE CHART.

5 Press either arrow button until you reach the desired setting.

USE CHART.
BOTH BLUE

6 Press and release the program button.

THIS LOCKS IN THE UP SETTING.
BOTH BLUE

THEN OFF

THIS CONFIRMS BOTH FORCE SETTINGS ARE SET.

7 Repeat "Force Control" on page 9

FORCE SETTINGS DONE

Repeat the Contact Reverse Test, page 9.

FORCE SETTINGS CHART

LED indicator colors: ○ OFF ● Blue ● Purple ● Red

Force Level	Powerhead LEDs	
	LONG LED	ROUND LED
Force Level 1	Off	● BLUE
Force Level 2	● BLUE	○ Off
Force Level 3	● BLUE	● BLUE
Force Level 4	Off	● PURPLE
Force Level 5	● PURPLE	○ Off
Force Level 6	● PURPLE	● PURPLE
Force Level 7	Off	● RED
Force Level 8	● RED	○ Off
Force Level 9	● RED	● RED

(continued next page)

5

Maintenance and Adjustments

LOCATING SAFE-T-BEAM PAIRS:

Source (Red LED) and Sensor (Green LED)

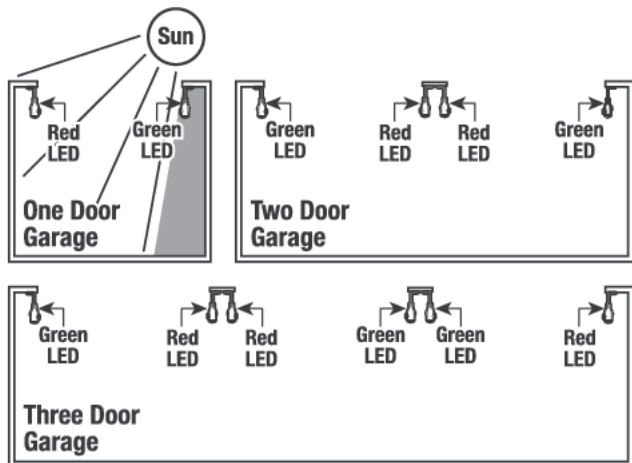

Multiple Garage Doors

- NEVER position Safe-T-Beam® modules where signals will cross.
- Place the Source (Red LED) Safe-T-Beams on adjacent doors facing in opposite directions.

NOTE: Direct sunlight creates interference with Safe-T-Beam® sensors (green LED). Sensor modules CAN be positioned further away from the door opening if necessary to avoid sunlight but no further off the wall to maintain alignment with the Source (red LED) module.

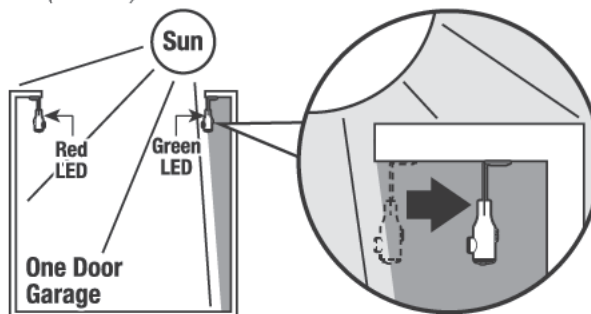

Single Garage Door

- Determine which side of the garage receives direct sunlight.
- Position the Source (Red LED) on the direct sunlight side.

6

Wiring Diagram (Basic Circuit—This diagram is for reference only.)

WARNING

ELECTRICAL SHOCK

OPENING COVER MAY CAUSE ELECTRICAL SHOCK

Disconnect power from opener prior to removing cover.

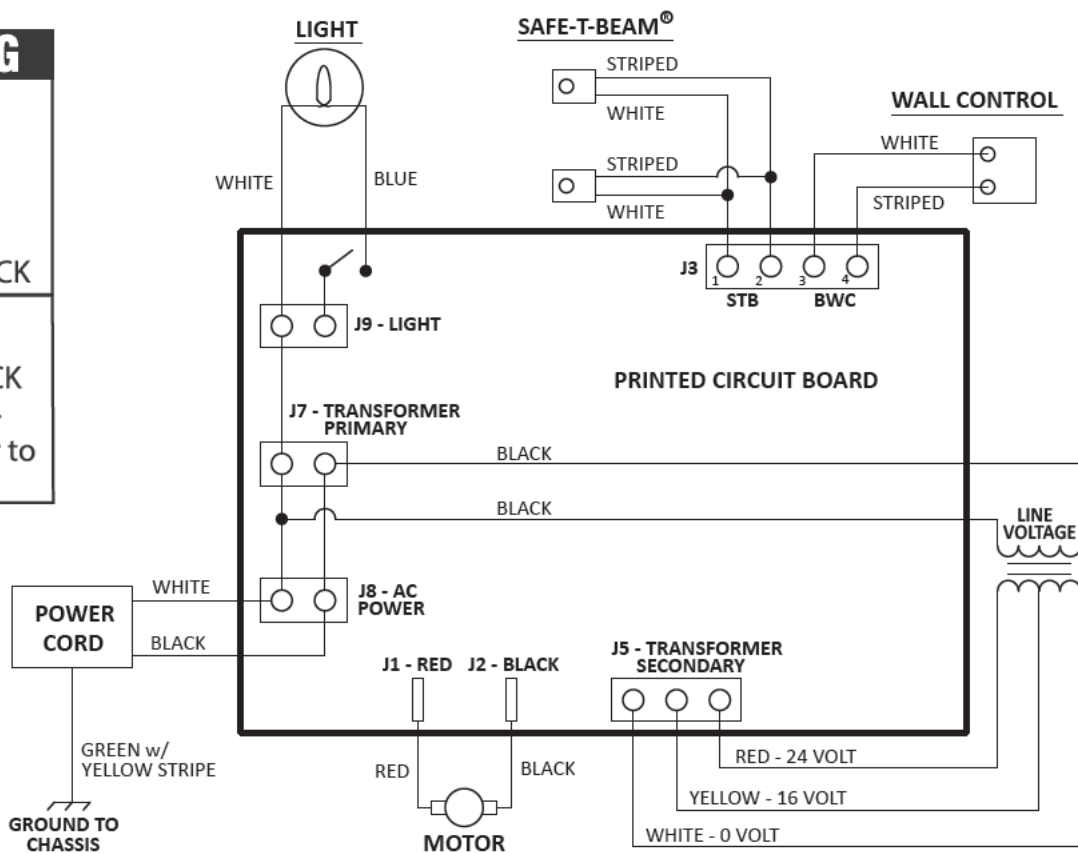

7 Troubleshooting



Need help or have questions? **DO NOT RETURN** to the store.
Visit www.geniecompany.com or call Genie at 1-800-354-3643

OPERATION

PROBLEM	WHAT TO DO
Opener does NOT run from wall console.	<ul style="list-style-type: none"> • Turn Sure-Lock™ OFF (see page 5). • Check power source. <ul style="list-style-type: none"> – Plug a lamp into outlet used for powerhead. If lamp works, power source is OK. – If not, check fuse or circuit breaker. • If power is OK, <ul style="list-style-type: none"> – Check connections at powerhead terminals and at wall console. • Check for reversed, broken or cut wires. Staples can cut insulation and short wires. Repair or replace.
Opener runs, but door does not move. Opener works from wall console, but NOT from remote.	<ul style="list-style-type: none"> • Make certain carriage is engaged with chain/belt bullet. See page 12. Refer to Installation poster or download poster from www.geniecompany.com. • Check to make sure chain/belt is not broken or OFF its pulley. • Check all remotes. • Replace remote battery with good one. See page 13. • Program remote to powerhead. See page 10.
Remote has less than 25 feet operating range or no operation.	<ul style="list-style-type: none"> • Relocate remote inside car and/or point remote at garage door. • Replace battery. See page 13. • Reposition door opener antenna. • Eliminate possible competing signals (satellite radio, etc.).
Door starts down, then STOPS and goes back up. OR Safe-T-Beam® System malfunction.	<ul style="list-style-type: none"> • If a NEW installation, check Door Arm position. Refer to Installation poster or download poster from www.geniecompany.com. • Check if limits are properly set. See pages 7-8 & 14. • Check if Safe-T-Beam® Red LED is flashing. • Check Safe-T-Beam® system for beam obstruction or misalignment of lenses. • Check garage door for binding. • If an operational problem exists, and opener will not close, the opener can be forced to close as follows: Press and hold the wall control button until door is completely closed. • Check for interference from adjacent Safe-T-Beam® units. • Contact Genie at 1-800-354-3643.
Door starts down, then STOPS before it is closed. OR Door will only open.	<ul style="list-style-type: none"> • Check Safe-T-Beam® wire connections at powerhead and at STBs. See page 5, STB instruction, poster or website • Check if limits are properly set. See pages 7-8 & 14. • Check CONTACT REVERSE. See page 9. • Check garage door for binding. • Check closing "FORCE" adjustment. See page 14.
Door starts up, but STOPS before it is completely open.	<ul style="list-style-type: none"> • Check if limits are properly set. See pages 7-8 & 14. • Be sure door, opener, and springs are in good repair, properly lubricated and balanced. • Check closing "FORCE" adjustment. See page 14. • ▲ WARNING: If you suspect a problem with the garage door hardware or springs, visit www.geniecompany.com and use the "dealer locator" to hire a local door service professional. <i>NEVER try to repair door hardware or springs yourself.</i>
Door will only run closed.	<ul style="list-style-type: none"> • Turn Sure-Lock™ OFF (see page 5). • Check if limits are properly set. See pages 7-8 & 14. • Check door balance, condition, and door spring. • Check opening "FORCE" adjustment. See page 14. • ▲ WARNING: If you suspect a problem with the garage door hardware or springs, visit www.geniecompany.com and use the "dealer locator" to hire a local door service professional. <i>NEVER try to repair door hardware or springs yourself.</i>
Door opener starts for no reason.	<ul style="list-style-type: none"> • Button stuck on wall control or remote. • Was remote lost or stolen? Erase all remotes from powerhead memory and program new remotes. See pages 10-11.

7 Troubleshooting

OPERATION (continued)

PROBLEM	WHAT TO DO
Noisy operation.	<ul style="list-style-type: none"> • Be sure all door fasteners are tight. • Be sure garage door is in good repair, properly lubricated and balanced. • Be sure opener is in good repair.
Door opener runs slow.	<ul style="list-style-type: none"> • Check operating condition of door. Door may need professional repair/adjustment. • Have you installed this opener on a one-piece door? This opener is not designed to operate a one-piece door!

POWERHEAD LEDS

Powerhead LED		Possible Problem	Solution
Round LED	Long LED		
OFF	OFF	Normal operation.	None required.
		No response from unit.	Check power supply. Contact a trained door system technician.
ON/RED/ STEADY	ON/RED/ STEADY	Limits NOT set properly.	Re-program limits, see pages 7-8.
ON/RED/ FLASHING	ON/RED/ FLASHING	Program error.	Unplug unit, wait 5 seconds, plug in.
		Component failure.	Contact a trained door system technician.
ON/BLUE/ FLASHING	OFF	Remote NOT programmed.	Program remote, see page 10.
ON/PURPLE/ FLASHING	OFF	Remote NOT programmed.	Program remote, see page 10.
ON/RED/ FLASHING	OFF	Safe-T-Beam® physical obstruction.	Remove obstruction, recheck unit.
		Safe-T-Beam® signal interference.	Check alignment of Safe-T-Beam® pair and nearest other Safe-T-Beam® pair, see page 15.
OFF	ON/RED/ FLASHING	Door contact in UP or DOWN travel.	Remove obstruction.
		Door component failure detected.	Check door spring, track, rollers, hinges and fixtures.
OFF	ON/RED/ STEADY	Thermal cutout	DO NOT unplug unit. Wait until LED clears before operating.
ON/PURPLE STEADY	ON/PURPLE STEADY	COMPONENT ERROR	Contact a trained door systems technician.
OFF	ON/BLUE FLASHING	Door will not open.	Check Sure-Lock™. Sure-Lock™ should be OFF for normal operation (see page 5).
ON/PURPLE FLASHING	ON/PURPLE FLASHING	Radio Receiver Error.	Unplug the unit. Wait 5 seconds and plug the unit back in. If problem persists, contact a trained door systems technician.



BELT/CHAIN DRIVE MODELS ReliaG® 650 and ReliaG® 850 Limited Warranty

The Distributor of the Genie Company products, whose name appears below ("Seller") warrants to the original purchaser of the ReliaG 650 & ReliaG 850 garage door openers ("Product"), subject to all of the terms and conditions hereof, that the Product and all components thereof will be free from defects in materials and workmanship for the following period(s) of time, measured from the date of installation:

- **MOTOR/GEARBOX** - Seller warrants the motor for the **FIVE (5) YEARS** for ReliaG 650
- **MOTOR/GEARBOX** - Seller warrants the motor for the **TEN (10) YEARS** for ReliaG 850
- **BELT** - Seller warrants the belt for a period of **FIFTEEN (15) YEARS**.
- **CHAIN** - Seller warrants the chain for a period of **FIVE (5) YEARS**.
- **PARTS** - Seller warrants all other parts and components for a period of **ONE (1) YEAR**.
- **ACCESSORIES** - Seller warrants all accessories for a period of **ONE (1) YEAR**

Seller's obligation under this warranty is specifically limited to repairing or replacing, at its option, the Product or any part thereof which is determined by Seller to be defective during the applicable warranty period. Any labor charges are excluded and will be the responsibility of the purchaser.

This warranty gives you specific legal rights, and you may also have other rights which vary from state to state. This warranty is made to the original purchaser of the Product only, and is not transferable or assignable. This warranty applies only to Product installed in a residential or other non-commercial application. It does not cover any Product installed in commercial or industrial building applications. This warranty does not apply to any unauthorized alteration or repair of the Product, or to any Product or component which has been damaged or deteriorated due to misuse, abuse, neglect, accident, failure to provide necessary maintenance, normal wear and tear, or acts of God or any other cause beyond the reasonable control of Seller, and does not cover batteries, or repairs or maintenance to door components.

ALL EXPRESS AND IMPLIED WARRANTIES FOR THE PRODUCT, INCLUDING BUT NOT LIMITED TO ANY IMPLIED WARRANTIES OF MERCHANTABILITY AND FITNESS FOR A PARTICULAR PURPOSE, ARE LIMITED IN TIME TO THE APPLICABLE WARRANTY PERIOD REFLECTED ABOVE. NO WARRANTIES, WHETHER EXPRESS OR IMPLIED, WILL APPLY AFTER THE LIMITED WARRANTY PERIOD HAS EXPIRED.

Some states do not allow limitations on how long an implied warranty lasts, so the above limitation may not apply to you.

IN NO EVENT SHALL THE GENIE COMPANY BE RESPONSIBLE FOR, OR LIABLE TO ANYONE FOR, SPECIAL, INDIRECT, COLLATERAL, PUNITIVE, INCIDENTAL OR CONSEQUENTIAL DAMAGES, even if The Genie Company has been advised of the possibility of such damages. Such excluded damages include, but are not limited to, loss of use, cost of any substitute product, or other similar indirect financial loss. Some states do not allow the exclusion or limitation of incidental or consequential damages, so the above limitation or exclusion may not apply to you.

Claims under this warranty must be made promptly after discovery, within the applicable warranty period and in writing to the Seller whose name and address appear below. The Purchaser must allow Seller a reasonable opportunity to inspect any product claimed to be defective prior to removal or any alteration of its condition. Proof of purchase and/or the installation date, and identification as the original purchaser may be required. Upon determination by Seller that the Product or any part thereof is defective during the applicable warranty period, Seller will supply the purchaser with replacement parts or, at its option, a replacement Product (shipping and handling of any replacement part(s) or replacement Product also at purchaser's expense). Seller may use new or reconditioned parts, or a new or reconditioned Product of the same or similar design.

There are no established informal dispute resolution procedures of the type described in the Magnuson-Moss Warranty Act.

PURCHASER: _____

INSTALLATION ADDRESS: _____

DATE PURCHASED: _____ SERIAL NUMBER: _____

OPENER MODEL: _____ REMOTE CONTROL MODEL: _____

DATE OF INSTALLATION: _____

NAME OF DISTRIBUTOR/INSTALLER: _____

ADDRESS OF DISTRIBUTOR/INSTALLER: _____

Looking for Leading-Edge Technology or the Perfect Update/Replacement?

Genie® Has the Answer!

Easy operation at your finger tips

"RETRO"
REPLACEMENT



GenieMaster™ 3-Button Remote

- Compatible with all Genie garage door openers manufactured from 1993 to the present
- Operates up to 3 openers
- Large, easy to find buttons for activation

Convenience, Security All in One

UPGRADE
WITH STYLE



Keyless Entry Pad

- Wireless; can open door without remote
- Lighted keypad with flip-up cover
- Controls up to three openers



White Gray Tan Almond

Color-Match These Covers to Your Home –
4 Color Options by Special Order



Perfect Stop Parking System

- Garage parking guide for extra safety
- Ball and string system attaches to door – enables safe parking in garage



Universal Wall Push Button

- Easy to mount inside garage
- Used in addition to other remotes or wall buttons

Check out NEW ACCESSORIES and PRODUCTS; visit www.geniecompany.com or call 1-800-35-GENIE.
Also available at Home Improvement outlets and other retail/commercial locations nationwide.





P.O.BOX 67
MT. HOPE, OHIO 44660

www.geniecompany.com
1-800-35-GENIE