

Installation Manual for the

GTO/PRO[®] 1000

Series



Automatic Gate Operator

for Vehicular Swing Gates

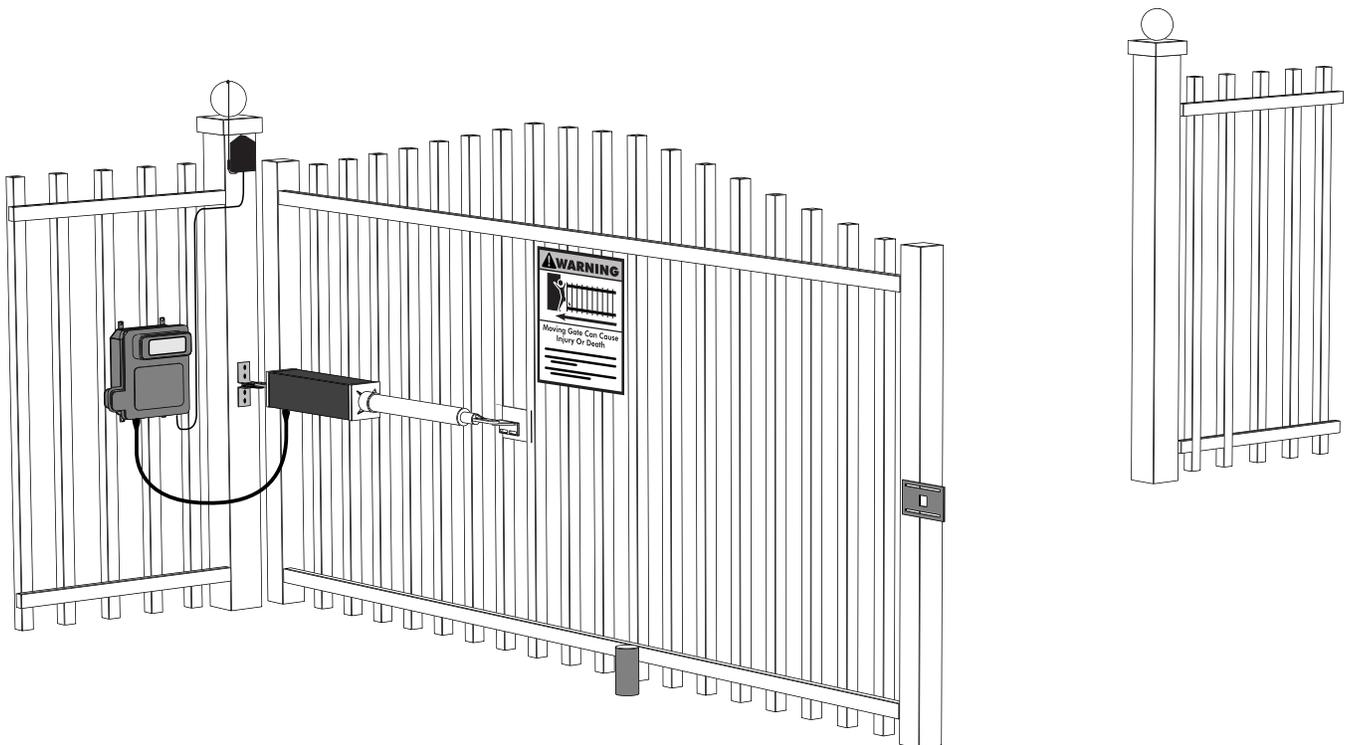

⚠ WARNING! ⚠

READ ALL INSTRUCTIONS CAREFULLY AND COMPLETELY before attempting to install and use this automatic gate operator. This gate operator produces a high level of force. Stay clear of the unit while it is operating and exercise caution at all times.

This product meets and exceeds the requirements of UL 325, the standard which regulates gate operator safety, as established and made effective March 1, 2000, by Underwriters Laboratories Inc.



3121 Hartsfield Road • Tallahassee, Florida, USA 32303
Telephone (800) 543-GATE or (850) 575-0176 • Fax (850) 575-8912 • www.gtoinc.com

© 2000 GTO, Inc.

GTO/PRO 1000 series automatic gate operators are intended for use with vehicular swing gates. These operators can be used in Class I, Class II and Class III applications.

VEHICULAR GATE OPERATOR CLASS CATEGORIES

Residential Vehicular Gate Operator-Class I: A vehicular gate operator (or system) intended for use in a home of one-to-four single family dwelling, or a garage or parking area associated therewith.

Commercial/General Access Vehicular Gate Operator-Class II: A vehicular gate operator (or system) intended for use in a commercial location or building such as a multifamily housing unit (five or more single family units), hotel, garages, retail store, or other building servicing the general public.

Industrial/Limited Access Vehicular Gate Operator-Class III: A vehicular gate operator (or system) intended for use in an industrial location or building such as a factory or loading dock area or other locations not intended to service the general public.

Restricted Access Vehicular Gate Operator-Class IV: A vehicular gate operator (or system) intended for use in a guarded industrial location or building such as an airport security area or other restricted access locations not servicing the general public, in which unauthorized access is prevented via supervision by security personnel.

Conversion Chart

<i>Converting Metric Units to English Equivalents</i>			
When You Know	Multiply By	To Find	Symbol
centimeters	0.3937	inches	in. (or ")
meters	3.2808	feet	ft. (or')
kilograms	2.2046	pounds	lb. (or #)
<i>Converting English Units to Metric Equivalents</i>			
When You Know	Multiply By	To Find	Symbol
inches	2.5400	centimeters	cm
feet	0.3048	meters	m
pounds	0.4535	kilograms	kg
<i>Converting Temperature</i>			
deg. Celsius	$(^{\circ}\text{C} \times 1.8) + 32$	deg. Fahrenheit	$^{\circ}\text{F}$
deg. Fahrenheit	$(^{\circ}\text{F} - 32) \div 1.8$	deg. Celsius	$^{\circ}\text{C}$

FOR YOUR RECORDS

Please record the serial number (located on the control box cover), and the date and place of purchase in the spaces provided below. Refer to this information when calling GTO for service or assistance with your automatic gate operator.

Serial Number _____ Date of Purchase _____ Place of Purchase _____

Remember to keep all receipts for proof of purchase.

TABLE OF CONTENTS

Safety Instructions	page 1
Technical Specifications	page 8
Single Gate Operator Installation	page 9
Parts Identification	page 9
Installation Overview	page 11
Installation of Mounting Hardware	page 14
Mounting the Operator	page 16
Installation of the Positive Stops	page 16
Mounting the Control Box	page 18
Setting the Closed Gate Position	page 19
Powering The System	page 20
Solar Panels and Gate Activity	page 20
Connecting the Transformer	page 20
Control Board Settings	page 23
DIP Switches	page 23
Potentiometers	page 24
Setting Your Personal Transmitter code	page 25
Mounting the Receiver	page 26
Connecting Additional Safety Devices	page 27
Compatible Safety Devices	page 28
Connecting Accessories	page 29
Push-To-Open Installation	page 30
Maintenance and Troubleshooting Guide	page 32
Warranty and Repair Service	page 34
Column Installation Information	page 35
Dual Gate System Installation	page 36
Parts List	page 36
Installing the Second Unit	page 37
Setting the Control Board for Dual Gate Installations	page 39
Accessory Manual	page 41
Installation Check List	back cover
4 1/2" x 4 1/2" Setback Template	insert

KEEP THESE INSTRUCTIONS FOR FUTURE REFERENCE

BEFORE INSTALLING THIS GATE OPERATOR:

Read these instructions carefully and completely to become familiar with all parts and installation steps.

IMPORTANT SAFETY INSTRUCTIONS

Because automatic gate operators produce high levels of force, all system designers, installers, and consumers have an obligation to know the potential hazards associated with improperly designed, installed, or maintained gate operator systems. *Keep in mind that the gate operator is just one component of the total gate operating system.* Each component must work in unison to provide the consumer with convenience, security, and safety.

This manual contains various safety precautions and warnings for the system designer, installer, and consumer. Because there are many possible applications of the gate operator, the safety precautions and warnings contained in this manual cannot be completely exhaustive in nature. They do, however, provide an overview of the safe design, installation, and use of this product. **CAREFULLY READ AND FOLLOW ALL SAFETY PRECAUTIONS, WARNINGS, AND INSTALLATION INSTRUCTIONS TO ENSURE THE SAFE SYSTEM DESIGN, INSTALLATION, AND USE OF THIS PRODUCT.**

The precautions and warnings in this manual are identified with  this warning symbol. The symbol identifies conditions that can result in damage to the operator or its components, serious injury, or death.

Because GTO automatic gate operators are *only part* of a total gate operating system. It is the responsibility of the designer, installer, and purchaser to ensure that the total system is safe for its intended use.

To Manually Open and Close the Gate, follow the procedure below:

Disconnecting the Operator

1. Turn control box **OFF**.
2. Remove hairpin clip, clevis pin, and washer from front mount.
3. Pull front mount away from gate bracket.

The gate can be opened and closed manually when the gate operator is disconnected.

NOTE: Substitute **Master® Pin Locks** for the clevis pins to prevent unauthorized removal of the operator from the gate (see *Accessory catalog*).

 **CAUTION:** Disconnect the operator only when the gate the control box power switch is **OFF** and the gate is **NOT** moving.

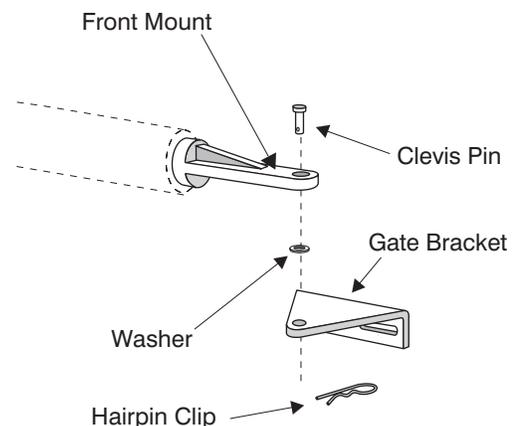

IMPORTANT SAFETY INSTRUCTIONS

For The System Designer

WARNING: To reduce the risk of injury or death:

1. **READ AND FOLLOW ALL INSTRUCTIONS.**
-  2. This operator is intended for use only on vehicular gates. Pedestrians must be supplied with a separate walk-through gate (*see Entrapment Protection illustration on page 6*).
3. When designing a system that will be entered from a highway or main thoroughfare, make sure the system is placed far enough from the road to prevent traffic congestion.
4. The gate must be installed in a location that ensures adequate clearance between it and adjacent structures when opening and closing to reduce the risk of entrapment. Swinging gates **shall not** open into public access areas.

IMPORTANT SAFETY INSTRUCTIONS for the Installer

WARNING—To reduce the risk of injury or death:

I. Before Installation

1. **READ AND FOLLOW ALL INSTRUCTIONS.**
2. Verify this operator is proper for the type and size of gate, and its frequency of use.
-  3. Make sure the gate has been properly installed and swings freely in both directions. Repair or replace all worn or damaged gate hardware prior to installation. A freely moving gate will require less force to operate and will enhance the performance of the operator and safety devices used with the system.
4. Review the operation of the system to become familiar with its safety features. Understand how to manually open and close the gate by disconnecting the operator (*see page 1*).
5. This gate operator is intended for vehicular gates **ONLY**. A separate entrance or gate must be installed for pedestrian use (*see page 6*). **NO ONE SHOULD CROSS THE PATH OF A MOVING GATE.**

II. During Installation

-  1. Install the gate operator on the inside of the property and fence line. **DO NOT** install an operator on the outside of the gate where the public has access to it.
-  2. Be careful with moving parts and avoid close proximity to areas where fingers or hands could be pinched.
-  3. The installation of additional safety equipment such as safety edges (or photoelectric sensors) is suggested for augmented protection against entrapment (*see page 6*).
-  4. Determine the best obstruction sensing setting for this installation. The gate **MUST** stop and reverse on contact with an obstruction or when an object activates the non-contact sensors. After adjusting the force or the limit of travel, retest the gate operator. **Failure to adjust and retest the gate operator properly can increase the risk of injury or death.**
5. Mount access controls away from the gate (**minimum** distance is 10 feet). The user must have full view of the gate but be unable to touch it while operating the controls.
6. Secure outdoor or easily accessed gate operator controls in order to prohibit unauthorized use of the gate.

IMPORTANT SAFETY INSTRUCTIONS

IMPORTANT SAFETY INSTRUCTIONS for the Installer

III. After Installation

1. Review **ALL** safety instructions with the consumer/end user and explain the basic operation and safety systems of the entire gate operator system, including disconnecting the operator for manual operation of the gate.
2. Attach the **warning signs** (included) to each side of the gate to alert public of automatic gate operation. Take a photo of warning signs installed on gate. Record the date of the photo for your reference.
3. **SAVE THESE INSTRUCTIONS.**
Leave a copy of the **IMPORTANT SAFETY INSTRUCTIONS** section of this manual with the consumer/end user.

IMPORTANT SAFETY INSTRUCTIONS

Secondary Means of Protection Against Entrapment

As specified by Underwriters Laboratories Inc. UL 325 (30A.1.1), automatic gate operators shall have *provisions for, or be supplied with*, at least one independent primary and one independent secondary means to protect against entrapment. GTO gate operators utilize **Type A**, an inherent (i.e., built-in) entrapment sensing system, as the **primary** type of entrapment protection. The GTO/PRO 1000 series operators have *provisions for* the connection of **Type B1 or B2** protection to be used as the **secondary** type of entrapment protection, if desired.

1. For gate operators utilizing a non-contact sensor (Type B1) in accordance with UL 325 (51.8.4 [h]):
 - A. Refer to the *sensor manufacturer's instructions* on the placement of non-contact sensors for each type of application.
 - B. Care shall be exercised to reduce the risk of nuisance tripping, such as when a vehicle trips the sensor while the gate is still moving.
 - C. One or more non-contact sensors shall be located where the risk of entrapment or obstruction exists, such as the perimeter reachable by a moving gate or barrier.
2. For gate operators utilizing a contact sensor (Type B2) in accordance with UL 325 (51.8.4 [i]):
 - A. One or more contact sensors shall be located at the leading edge, bottom edge, and post mounted both inside and outside of a vehicular swing gate system.
 - B. A hard wired contact sensor shall be located and its wiring arranged so that the communication between the sensor and the gate operator is not subjected to mechanical damage.
 - C. A wireless contact sensor such as one that transmits radio frequency (RF) signals to the gate operator for entrapment protection functions shall be located where the transmission of the signals are not obstructed or impeded by building structures, natural landscaping or similar obstruction. A wireless contact sensor shall function under the intended end-use conditions.

ENTRAPMENT ALARM (UL 325; 30A.1.1A)

The GTO/PRO 1000 series operators are designed to stop and reverse for 2 seconds when the gate comes in contact with an obstruction or when an object activates the non-contact sensors. Additionally, these operators are equipped with an **audio entrapment alarm** which will function if the unit obstructs *twice* while opening or closing. This alarm will sound for a period of 5 minutes or until the operator receives an intended signal (e.g., transmitter signal) and the gate returns to a fully open or fully closed position.

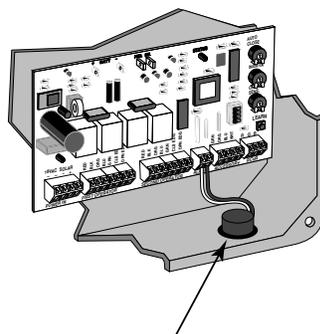

Entrapment Alarm
(bottom right of control box)

IMPORTANT SAFETY INSTRUCTIONS

For The Consumer/End User

WARNING: To reduce the risk of injury or death:

-  1. **READ AND FOLLOW ALL INSTRUCTIONS.**
-  2. Distribute and discuss copies of the **IMPORTANT SAFETY INSTRUCTIONS** section of this manual with all persons authorized to use your gate.
-  3. Always keep people and objects away from the gate and its area of travel.
NO ONE SHOULD CROSS THE PATH OF THE MOVING GATE.
-  4. Your automatic gate is not for pedestrian use. If pedestrian traffic is expected near the gate, a walk-through gate must be installed for this purpose (*see page 6*).
-  5. Do not allow children or pets near your gate. **Never let children operate or play with gate controls.** Keep the remote controls away from children and unauthorized users; store controls where children and unauthorized users cannot access them.
-  6. If push buttons or key switches are installed, they should be within sight of the gate, yet located far enough from it (at least 10 feet) so the gate cannot be touched while it is in operation. Do not operate any control without watching the movement of the gate.
-  7. Do not activate your gate operator unless you can see it and can determine that its area of travel is clear of people, pets, or other obstructions.
-  8. It is your responsibility to make sure that the installer posted warning signs on both sides of your gate. If any of these signs or warning decals become damaged, illegible or missing, replace them immediately. Contact your installer or GTO for replacements.
-  9. If electric safety edge sensors (or photoelectric sensors) have been installed (*see page 6*) they should be tested monthly for proper function.
-  10. **KEEP GATES PROPERLY MAINTAINED.** Clean the push-pull tube with a soft, dry cloth and apply silicone spray to it at least once per month.
-  11. Test your gate operator monthly and service it regularly. The gate **MUST** stop and reverse on contact with an obstruction or when an object activates the non-contact sensors. If these functions are observed to operate improperly, discontinue use and have the operator serviced immediately.
-  12. To operate this equipment safely, **YOU** must receive detailed instructions on disconnecting the operator for manual gate operation (*see page 1*). If you feel you have not received full and proper instructions, contact your installer.
-  13. Disconnect the operator **only** when the control box power switch is **OFF** and the gate is **NOT** moving.
-  14. **SAVE THESE INSTRUCTIONS**

IMPORTANT SAFETY INSTRUCTIONS

Required Safety Precautions for Gates

Install Warning Signs

Warning signs alert people of automatic gate operation and are required when installing the GTO/PRO 1000 and series gate operators. Furthermore, a walk-through gate must be installed if pedestrian traffic is expected near the vehicular gate. We recommend the GTO Bulldog Pedestrian Gate Lock (see *Accessory Catalog*) for controlled access.

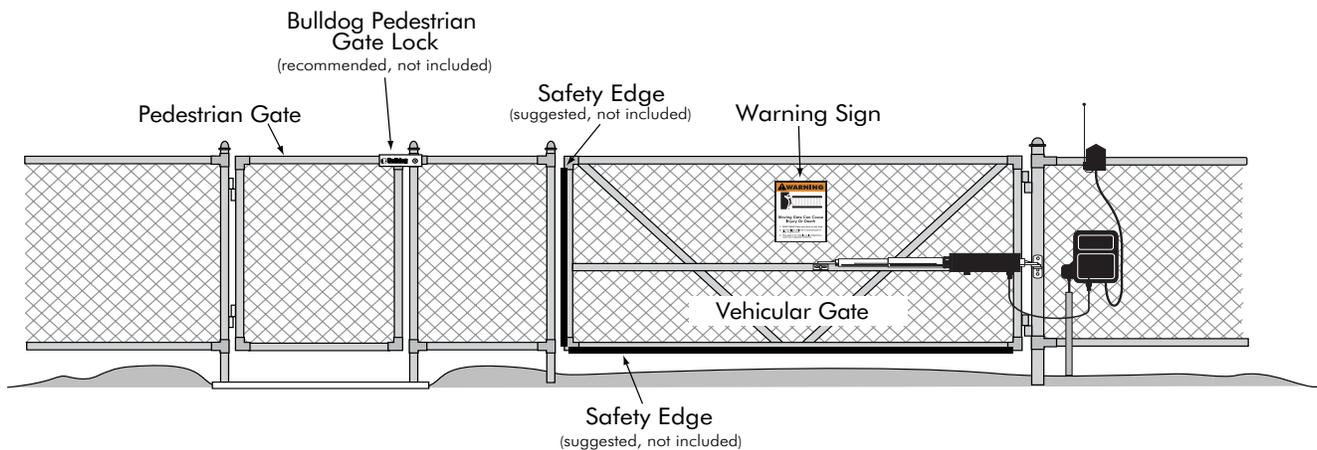

Entrapment Protection

GTO's internal obstruction settings, even when properly adjusted, *may not be sensitive enough to prevent bodily injury in some circumstances*. For this reason, safety devices such as safety edge sensors (or photoelectric sensors), which stop and reverse gate direction upon sensing an obstruction, are suggested for augmented protection against entrapment.



Warning Signs

The warning signs (*at left*) must be installed on both sides of the gate (*see page 7 for details*).

IMPORTANT SAFETY INSTRUCTIONS

These warning labels should be found at the locations specified below. If any of them are missing, immediately contact your installer for replacements.



warning signs (2 enclosed) to be installed on each side of the gate (3–5 feet above the bottom of the gate)

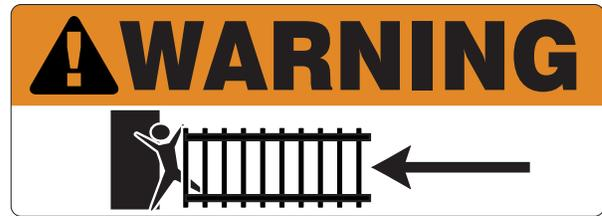

warning labels (2) installed on each side of operator housing

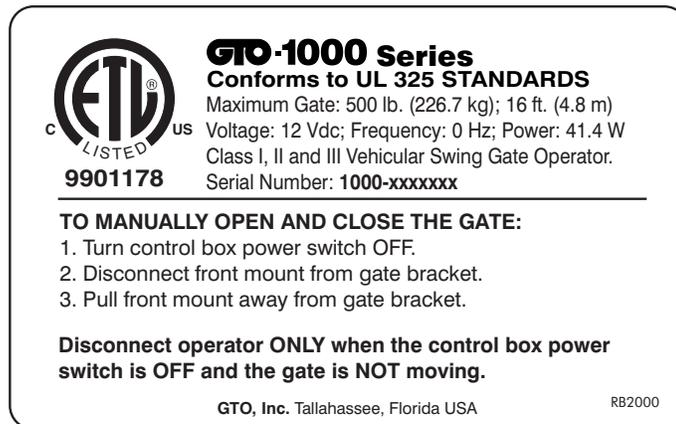

product identification and manual operation instruction label (1) installed on control box cover

Technical Specifications

GTO/PRO 1000 Series Swing Gate Operators

DRIVE

- Low friction screw drive (linear actuator) rated for -30 °F to +200 °F. Powered by a 12 V motor with integral case hardened steel gear reducer. Motor speed reduced to 220 rpm. Generates 330 ft.. lb. of torque at 12 V;
- 90° opening time: 15 s to 17 s, depending on weight of gate.

POWER

- The **GTO/PRO 1000** system is powered by a 12 Vdc, 7.0 Ah, sealed, rechargeable battery
- Battery charge for **GTO/PRO 1000** is maintained by a 120 Vac, 18 Vac (20 VA) transformer rectified to 14.5 Vdc through the **GTO** Control Board. Two (2) blade-style control board fuses are rated for 15 A. **NOTE: The transformer should not be connected directly to any battery. Do not replace fuses higher ampere rated fuses; doing so will void the warranty and may damage the control board.**
- Battery charge maintained by **GTO** Solar Panel Charger: float voltage 14.5 Vdc output from a 19³/₈" x 8¹/₂" silicon alloy panel. Generates minimum of 5 W at 300 mA. Gated diode on the control board prevents battery discharge. **NOTE: The solar charger should not be connected directly to any battery.**

CONTROL

- **GTO** microprocessor-based control board is set for single leaf, pull-to-open gate installations. DIP switches can be adjusted to accommodate an optional kit for push-to-open gates (*see Accessory Catalog*).
- Control board has temperature compensated circuits.
- A circuit on control board regulates charging. "Sleep draw" is 40 mA; "active draw" is 2 to 5 A.
- Auto-memorization of digital transmitter code.
- **GTO** remote-mounted RF receiver tuned to 318 MHz.
- Limit controls are mechanical. Adjustable range of push-pull tube is 7¹/₂" to 11¹/₂". Operator length with push-pull tube fully retracted is 33³/₄", mounting point to mounting point.
- Adjustable auto-close timer (OFF to 120 s), inertia, and obstruction sensitivity using three (3) potentiometers.
- Power terminal block accommodates a transformer and solar panels.
- DIP switches simplify setup of gate operator.
- Accessory terminal block fully compatible with push button controls, digital keypads, safety loops, etc.
- Control board allows connection of safety edge sensors and photoelectric sensors.
- Audio entrapment alarm sounds if unit encounters an obstruction twice while opening or closing.

OPERATIONAL CAPACITY

- Depending upon length of the gate and the number of operational cycles per day, the **GTO/PRO 1000** can operate gates weighing up to 500 pounds, **if all proper installation procedures have been followed.** *Ball bearing hinges should be used on all gates weighing over 250 pounds.*

Gate Length	16 ft.	135	120	105	NONE	NONE	NONE	NONE
	14 ft.	145	130	115	100	70	NONE	NONE
12 ft.	155	140	125	110	80	40	NONE	
3.5-10 ft.	165	150	135	120	90	50	10	
	50 lb.	100 lb.	150 lb.	200 lb.	300 lb.	400 lb.	500 lb.	
	Gate Weight							

NOTE: An operation cycle is one full opening and closing of the gate. The numbers shown in this chart are for single gate applications, cycles for dual gate applications will be about half of those with a single gate.

These are the recommended guidelines when using the ac transformer (*included*) to trickle charge the battery. See page 20 for information about maximum cycles provided by the **GTO/PRO 1000** when using the **GTO** Solar Panel.

These specifications are subject to change without notice.

Parts Identification

Single Gate Operator and Hardware

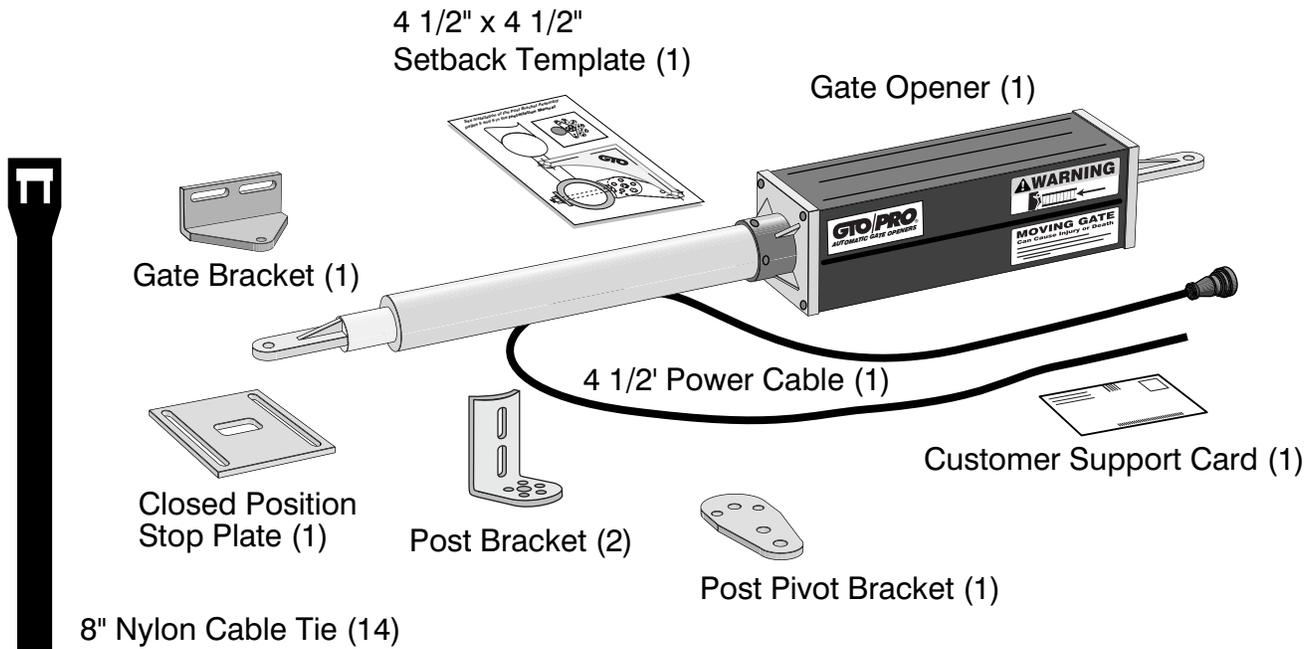

Hardware

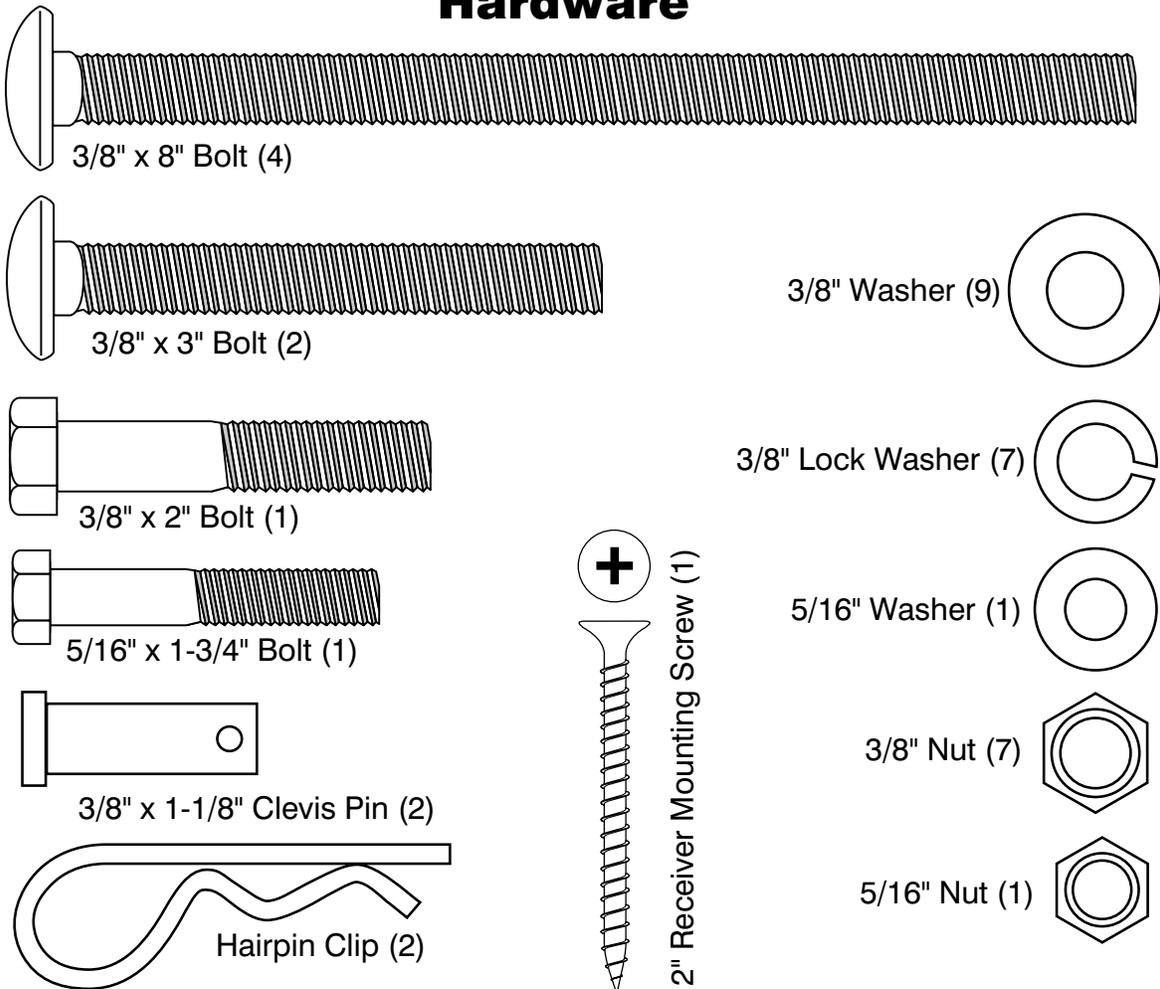

Single Gate Operator Parts List

Control Box and Electrical Components

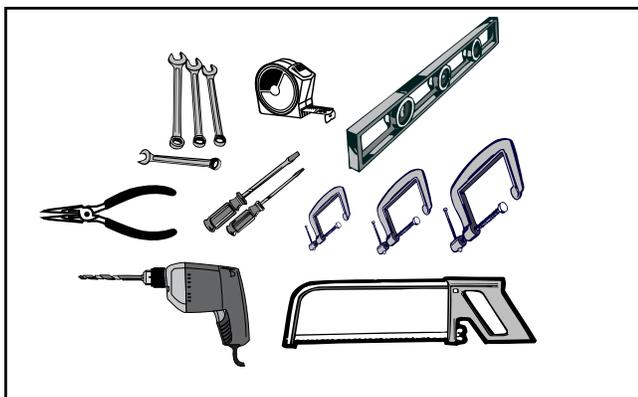
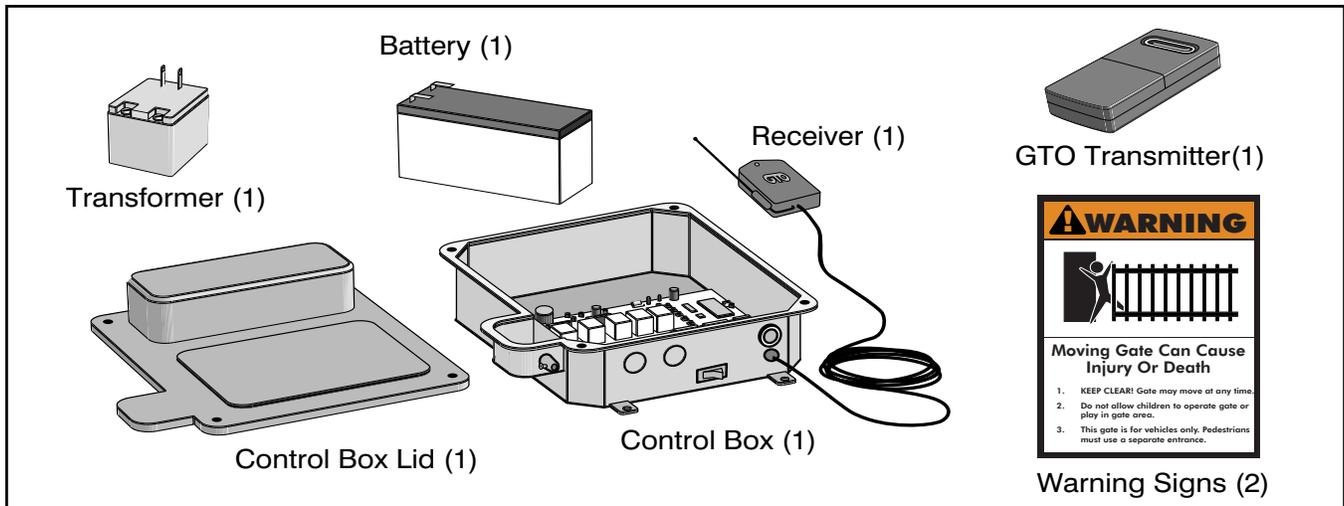

Tools Needed

- Power Drill
- Open End Wrenches — 3/8", 7/16", 1/2", and 9/16"
- 3/8" Drill Bit
- Hacksaw or Heavy Duty Bolt Cutters
- Slotted (Flat Bladed) Screwdriver
- Phillips Screwdriver
- Tape Measure
- Level
- Wire Strippers
- C-Clamps — small, medium, and large

ALSO, YOU WILL NEED THESE ITEMS BEFORE YOU BEGIN THE INSTALLATION (Some of these items can be found in the *Accessory Catalog* on page 42):

- The gate needs a **stop post** for the open position. This post is not provided. See page 16, **Installation of the Positive Stops** for more information.
- Additional **low voltage wire** (16 gauge) will be needed; length depends upon the distance between the transformer power supply and the control box. See page 20, **Powering the System** and the *Accessory Catalog*.
- If your gate is more than 1000' away from an ac power source you will need to use at least one **GTO Solar Panel** to trickle charge the battery. See the *Accessory Catalog*.
- If your fence post is made of wood and is less than 6" in diameter or 6" square, see page 14.
- If your fence post is larger than 6" in diameter you will need **threaded rods or carriage bolts longer than 8"**. See page 15.
- If you have thin walled tube or panel gates, see page 14 for **Recommended Reinforcement Examples**.
- Depending on the type of gate, a **horizontal cross member or mounting plate may be needed** to mount the front of the operator and gate bracket to the gate. See page 11, step 2; page 15, step 10.
- **Power cables 25' and 40' long** are available for mounting your control box away from the gate (i.e., in a more secure location). See the *Accessory Catalog*.

Installation Overview

Pull-to-Open Gates (Gate Opens into the Property)

The diagram below is an example of a pull-to-open installation on a chain link fence and single gate. If you are installing a push-to-open gate system, see **Push-to-Open Installation** starting on *page 30*. Mounting the operator on a masonry column requires special procedures; *see Column Installation Information on page 35* before proceeding.

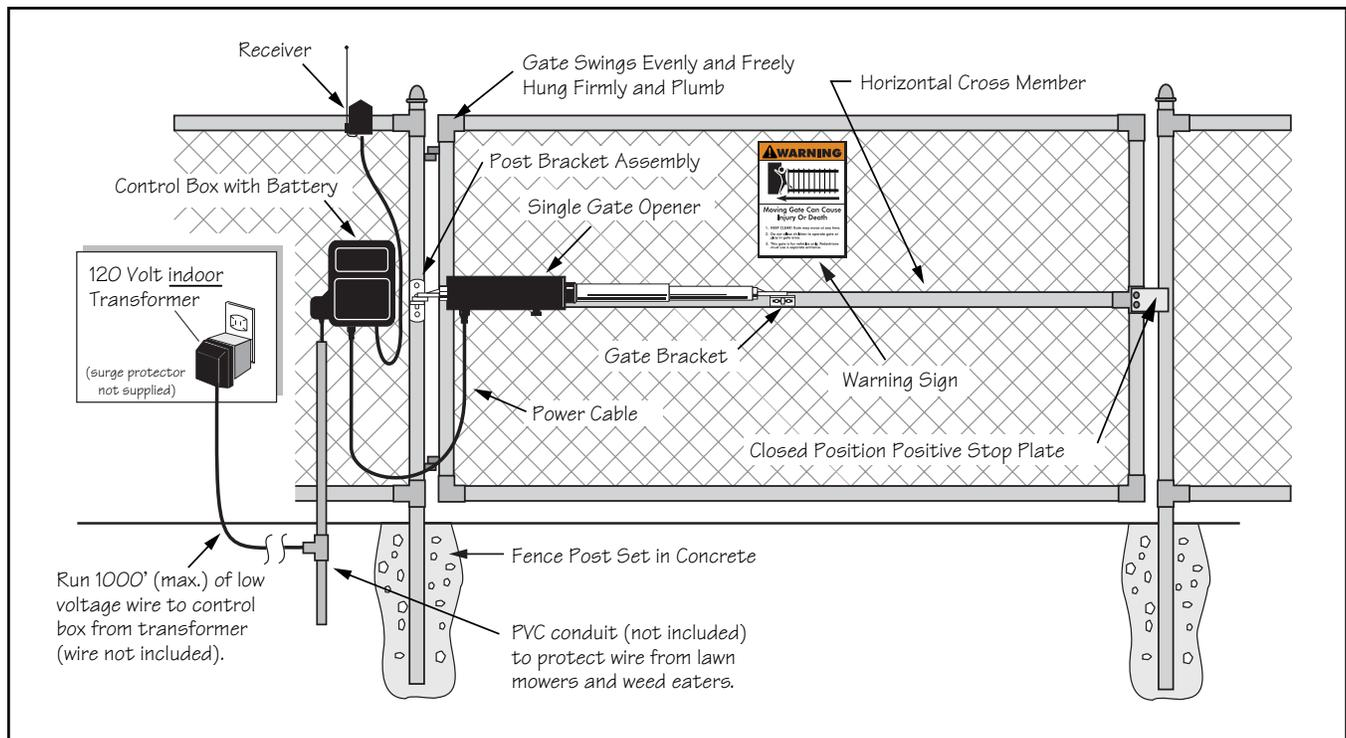

Preparing the Gate

Step 1:

The gate **must** be in proper working order, plumb, level and swinging freely on its hinges. Do not use wheels on gate. The gate must move smoothly and evenly throughout its swing, **without binding or dragging on the ground**. Gates over 250 pounds *should* have ball bearing hinges with grease fittings.

Step 2:

The fence post must be strongly secured in the ground with concrete so it will not twist or flex when the operator is powered. It is important to position the operator near the **centerline** of the gate to keep the gate from twisting and flexing. The addition of a **horizontal or vertical cross member** may be necessary (if one is not already in place) to provide a stable area to which the gate bracket can be secured.

For the operator to function properly, Steps 1 & 2 must be complete before proceeding to the next step.

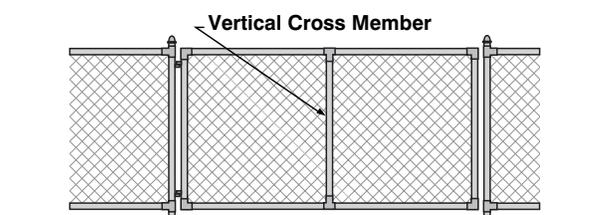
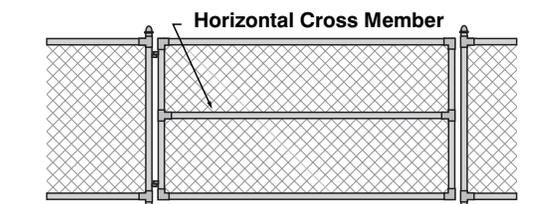

Determining The Mounting Position of The Post Bracket Assembly and The Gate Bracket

Step 3:

Join the post bracket assembly using the 3/8" x 2" bolt in the center holes as shown. Fasten a 3/8" washer and nut on the end of the bolt. **DO NOT overtighten** nut because the post pivot bracket will need to be adjusted later.

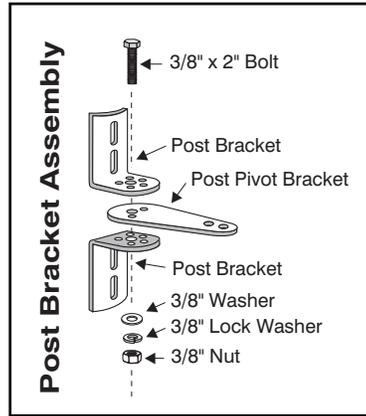

Step 4:

Attach the post bracket assembly and the gate bracket to the operator with the clevis pins and washers. Secure the clevis pins with hairpin clips.

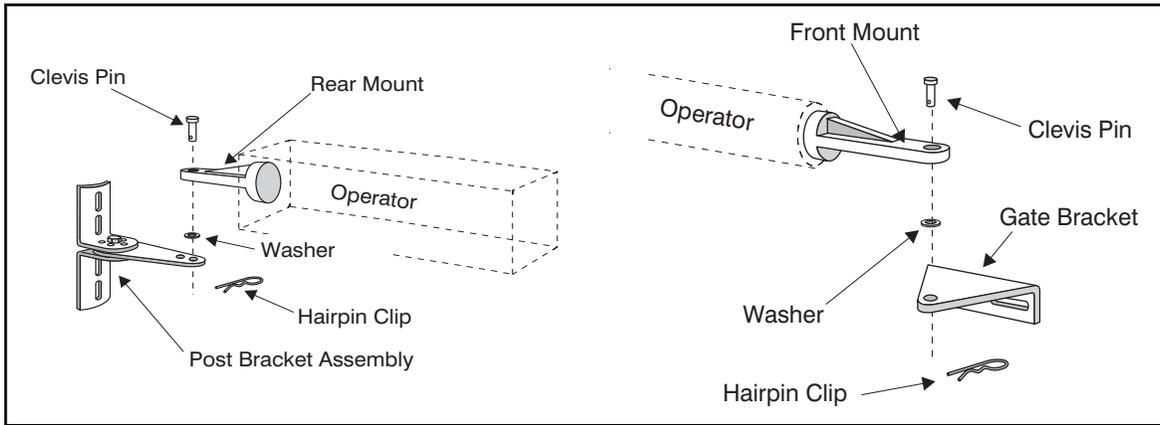

Step 5:

With the gate in the open position (at least 80° and no more than 110° from the closed position), determine the position of the post bracket assembly and the gate bracket. While holding the operator in a level position (use a level), clamp these parts in their respective positions on the fence post and the gate.

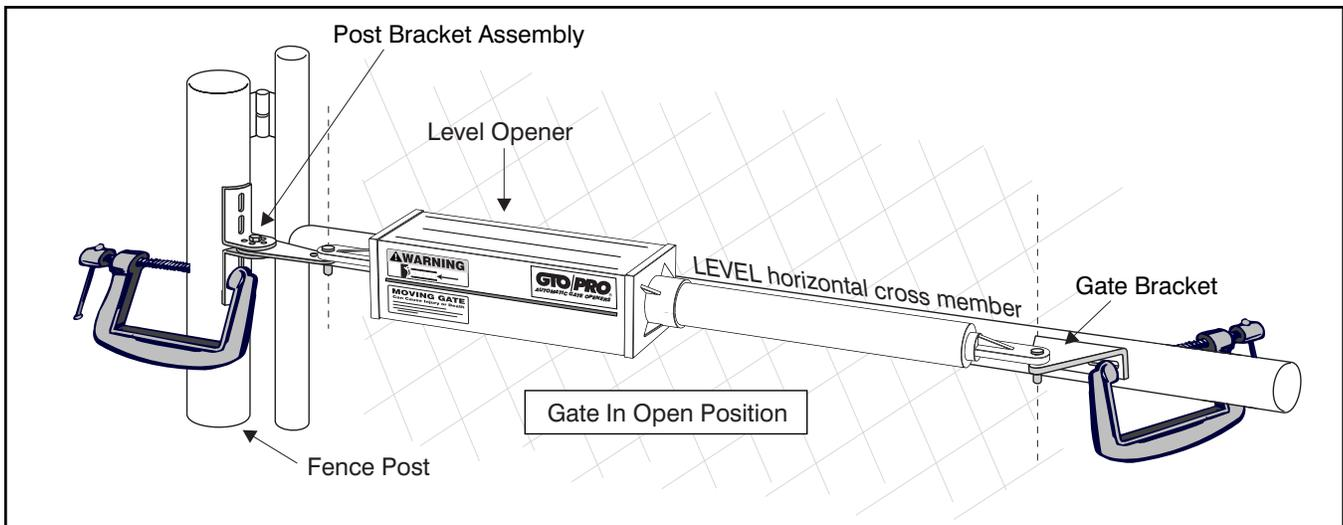

Step 6

Study the 4 1/2" x 4 1/2" setback template (see insert) provided with this manual. Once you are familiar with its illustrations, **cut and save the template** from the insert. The template will determine the correct position of the post pivot bracket before mounting the operator on the fence post. Remove hairpin, clevis pin, and washer from operator and close the gate. Rest disconnected operator on cross member of gate. Stand inside property next to fence post and place one end of template over center of gate hinge. Place the other end of template over the post pivot bracket hole (either of the two mounting holes in post pivot bracket can be used) where the operator will be attached. Be sure to hold the template at a 90° angle between these two points and measure 4 1/2" back from the center of the gate hinge. You will need to rotate the post pivot bracket or the entire post bracket assembly to align it with the *square* angle of the template. **THE ANGLE BETWEEN THE GATE HINGE AND THE POST PIVOT BRACKET MUST MATCH THE ANGLE OF THE SETBACK TEMPLATE.**

Remove hairpin, clevis pin, and washer from operator and close the gate. Rest disconnected operator on cross member of gate. Stand inside property next to fence post and place one end of template over center of gate hinge. Place the other end of template over the post pivot bracket hole (either of the two mounting holes in post pivot bracket can be used) where the operator will be attached. Be sure to hold the template at a 90° angle between these two points and measure 4 1/2" back from the center of the gate hinge. You will need to rotate the post pivot bracket or the entire post bracket assembly to align it with the *square* angle of the template. **THE ANGLE BETWEEN THE GATE HINGE AND THE POST PIVOT BRACKET MUST MATCH THE ANGLE OF THE SETBACK TEMPLATE.**

NOTE: When you move the post pivot bracket, be sure one of the post bracket holes is aligned with the rest of the assembly (center hole should already have bolt through it). **Flipping the Post Pivot Bracket gives more position options.**

After verifying that you have complied with the 4 1/2" x 4 1/2" setback, insert the 5/16" x 1 3/4" bolt through the aligned holes of the post bracket and post pivot bracket (illustrated below) and fasten it with the 5/16" washer and nut. **IMPORTANT:** If you loosened the clamp on the post bracket to achieve the 4 1/2" x 4 1/2" setback, tighten it in its new position and recheck gate bracket with the gate in its open position (move the gate bracket and re-clamp it if necessary).

Examples of a 4 1/2" x 4 1/2" Setback

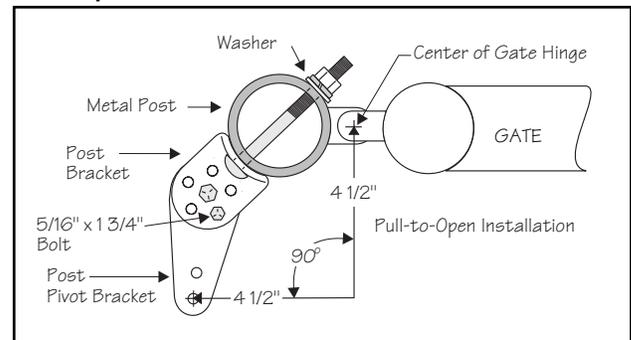
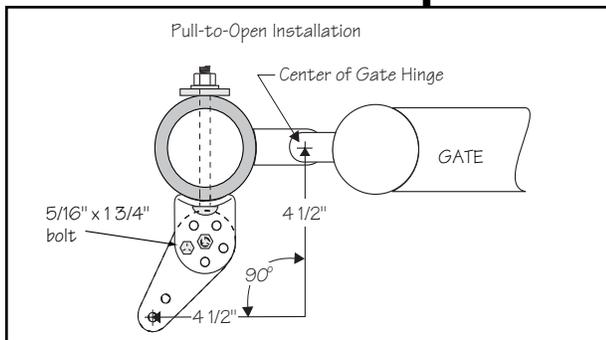

IMPORTANT

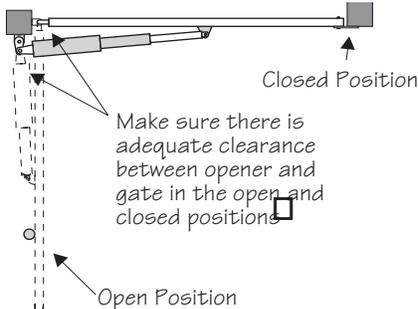

Verify the Position of the Gate Bracket and Post Bracket Assembly:

With the gate in the open position, make sure the following conditions are met:

1. The operator is level.
2. The 4 1/2" x 4 1/2" setback measurement is correct (**Step 6**).
3. There is sufficient clearance between operator and gate in the open and closed positions.

Installation of Mounting Hardware

The post bracket position determines both the leverage and efficiency of the operator, and the clearance between the operator and the gate in the open and closed positions.

The post bracket is designed with a curvature that works well with installations on both round and square fence posts. Since the post bracket carries the entire back thrust of the active operator, it is absolutely necessary that it be mounted with bolts that completely penetrate the fence post.

On wooden posts, it is best to use a metal plate or washer between the nuts and the gate post to prevent the operator from pulling the bolts and washers through the wood.

NOTE: Any fence post under 6" in diameter or 6" square should be made of metal not wood.

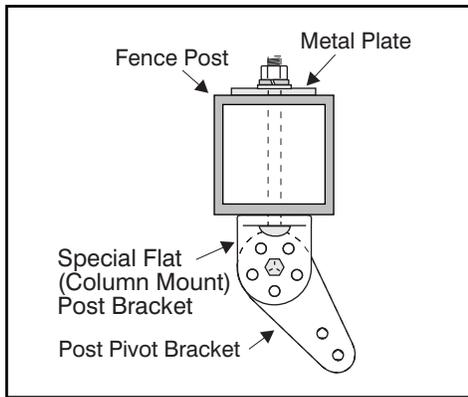
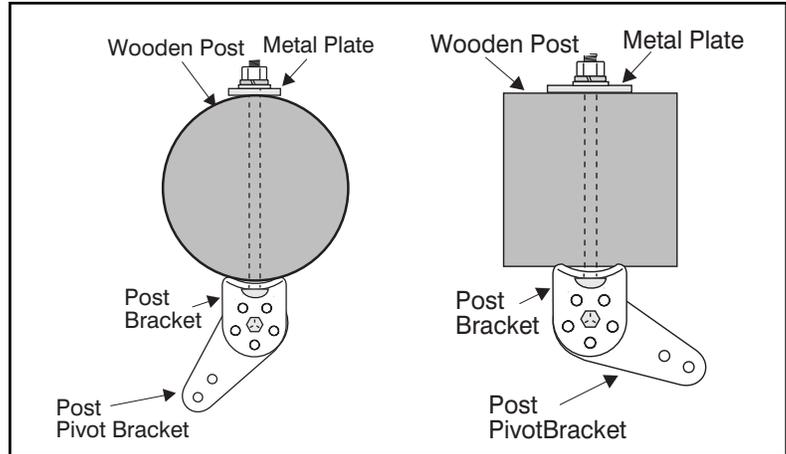

For best installations on flat wooden posts, columns, steel plates or other flat mounting, use the special flat column mount post bracket. (see *Accessory Catalog.*)

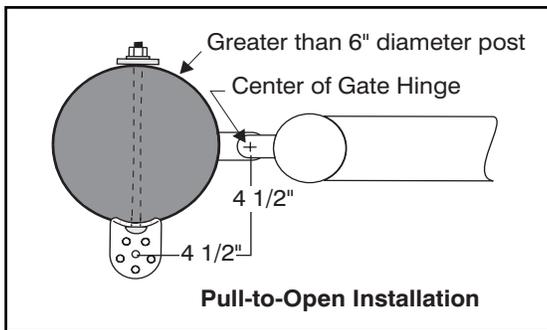

On round posts of 6" diameter or larger, the post pivot bracket may not be needed for the installation. Just use the two post brackets by themselves.

Reinforcement Examples

IMPORTANT:

We **strongly recommend** reinforcing thin walled tube and panel gates as shown to prevent damage to gate and operator.

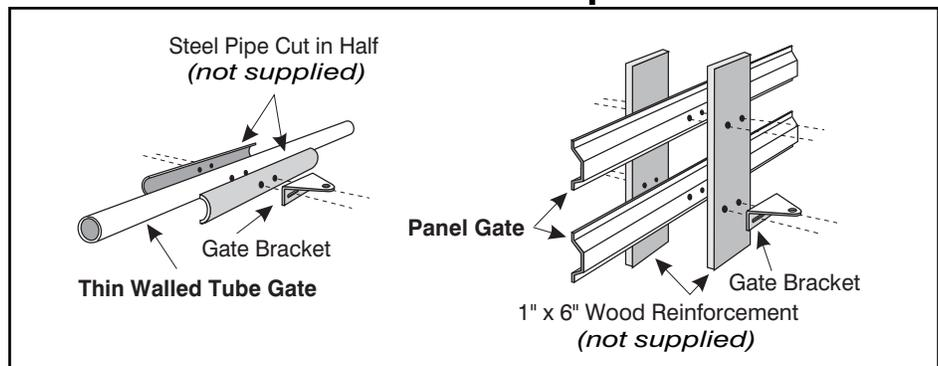

Installing The Post Bracket Assembly and Gate Bracket

Step 7:

Mark the holes in the middle of the bracket slots so there will be some room for adjustment when mounting the post bracket assembly and the gate bracket on the fence post and gate cross member. Then remove the operator and brackets from the fence and gate.

Step 8:

Drill $\frac{3}{8}$ " holes in the fence post as marked.

Step 9:

Install the post bracket assembly using (4) $\frac{3}{8}$ " x 8" bolts, nuts, washers and lock washers provided. Cut off the ends of the bolts extending beyond the tightened nuts.

NOTE: if the fence post has a diameter greater than 6", it will be necessary to use threaded rods or carriage bolts longer than 8" (*not supplied*).

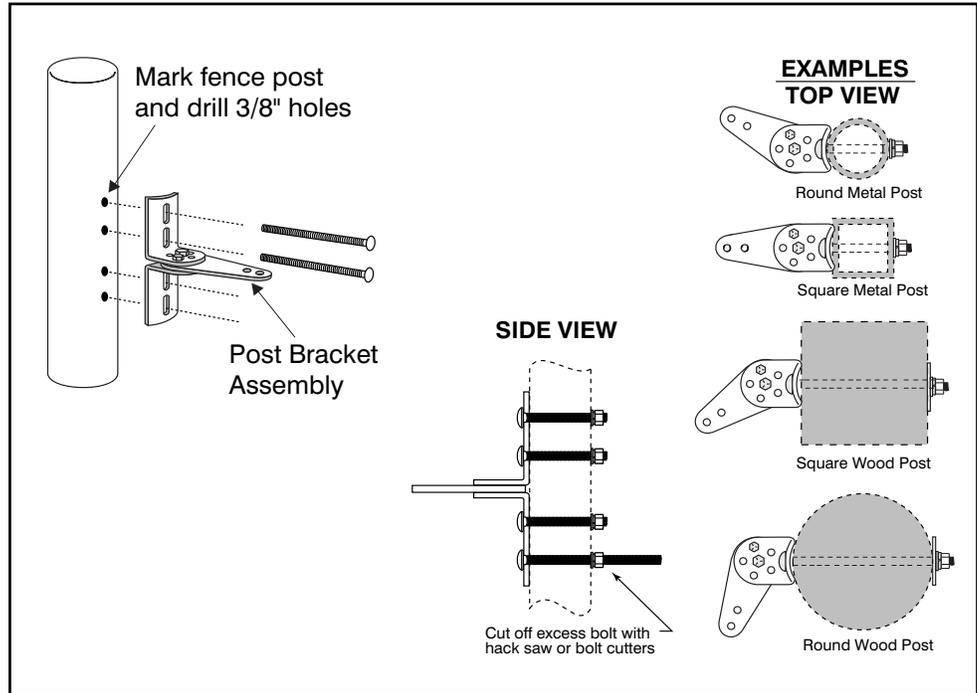

Step 10:

Drill $\frac{3}{8}$ " holes in the gate cross member and mount the gate bracket with the $\frac{3}{8}$ " x 3" bolts, washers nuts, and lock washers provided. Cut off the ends of the bolts extending beyond the tightened nuts with hacksaw or bolt cutters.

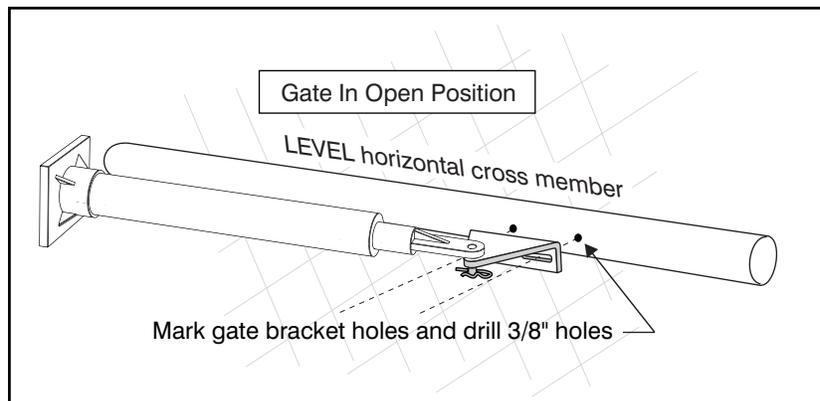

Gate Bracket Mounting Examples

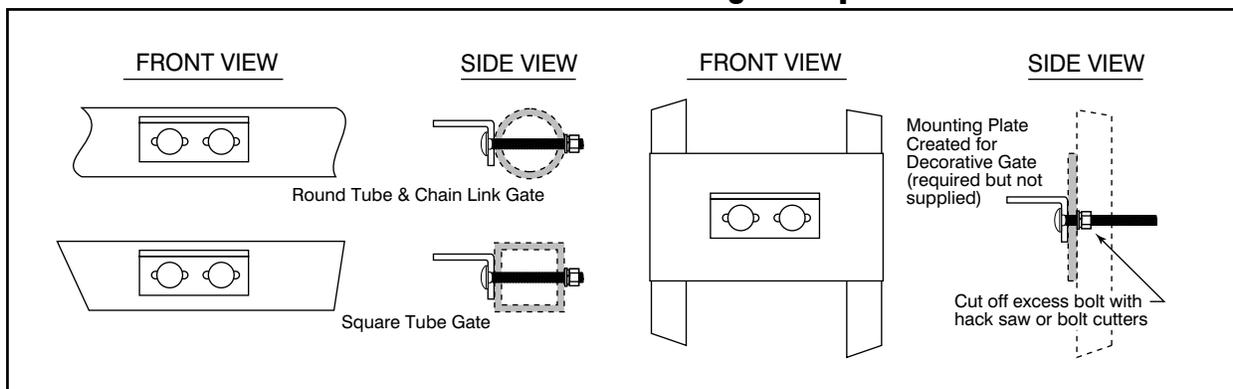

Mounting the Operator

Step 11:

Attach the operator to the securely mounted post bracket assembly and gate bracket using the clevis pins and hairpin clips or optional Master Pin Locks (see *Accessory Catalog*). **Check the level of the operator, and adjust the post bracket assembly if necessary.**

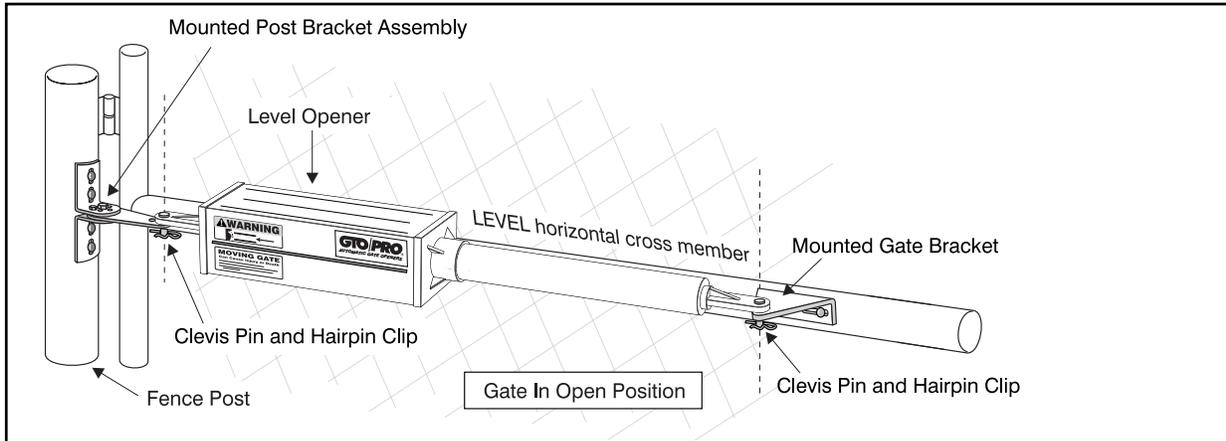

Installation of the Positive Stops (Open and Closed Positions)

The positive stops hold the gate firmly in the open and closed positions. The positive stops also form the boundaries of the gate operating arc and help stabilize the gate. Moreover, a stable gate helps to maintain the long life of your automatic gate opener system. To further enhance the stability and security of your gate, install the optional **GTO Automatic Gate Lock** (see *Accessory Catalog*).

*Note: If you are installing dual gate operators, install all positive stops at the same time. Please refer to **Installing a Dual Gate System** beginning on page 36.*

Step 12:

With the gate in the maximum open position, measure approximately $\frac{2}{3}$ of the distance to the end of the gate from the hinges and place a mark on the ground directly under the gate. Install the open position stop at this mark. The open position stop post can be made of wood, metal or concrete and should be secured firmly in the ground (we recommend seating in concrete). When the open position stop post is in the ideal position, the gate will strike the post just as the operator motor shuts down.

Step 13:

Remove the hairpin, clevis pin, and washer from the operator and close the gate (be sure to support operator). Install the closed position stop plate on the end of the gate frame at mid-height. Extend the stop plate to make contact with the fence post at that position.

NOTE: Use appropriate hardware for the type of gate (U-bolts if you have a tube or chain link gate, wood or lag screws for wood gates, etc.). This hardware is not provided.

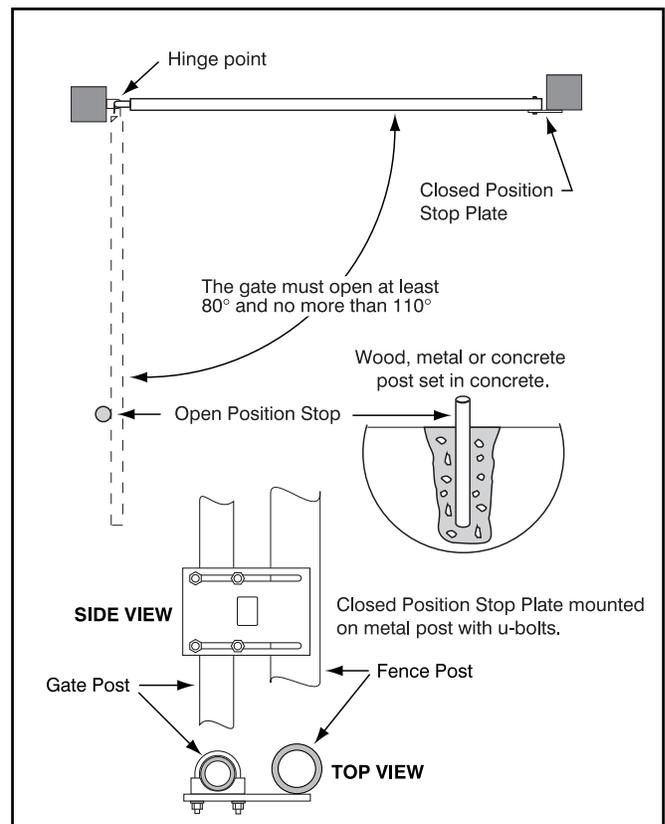

At this stage of the installation, the operator should be installed on the gate and the open and closed position stops should be in place.

Check List

- The gate is plumb, level, and swings smoothly on its hinges.
- After measuring with the 4 1/2" x 4 1/2" setback template, the post bracket assembly was bolted to the fence post.
- A plate or support was added for the gate bracket (if necessary).
- The operator is level and mounted on the centerline of the gate.

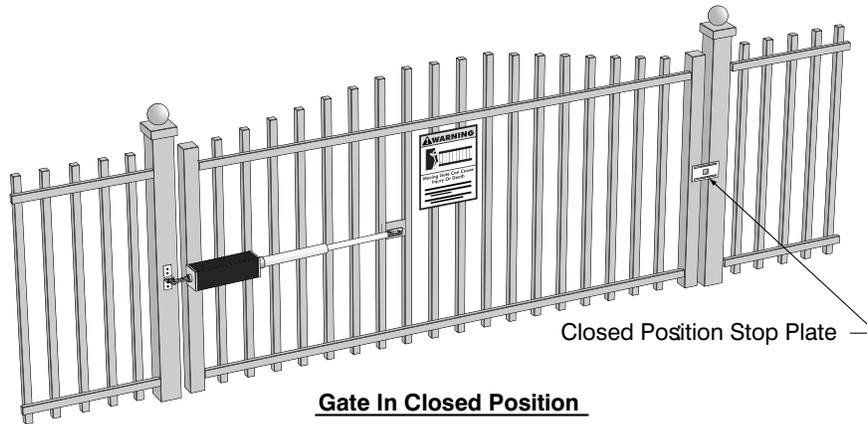

Open Position Stop Post
(set in concrete) → 

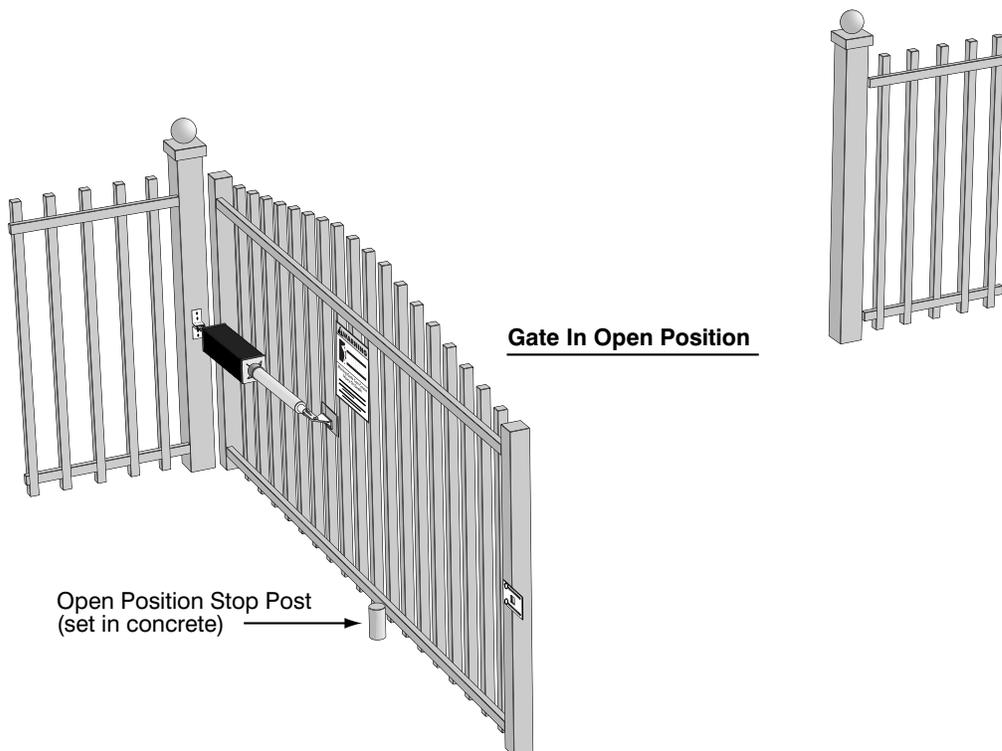

Mounting the Control Box

Step 14

Mount the control box using the nylon cable ties (*provided*) or another secure mounting method. The control box must be mounted at least **3 feet above the ground** to protect it from rain splash, snow, etc., and at least **3 feet from an ac power source** to prevent electrical interference.

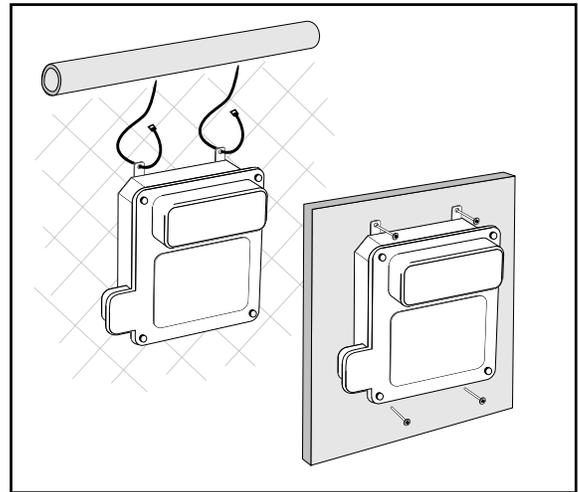
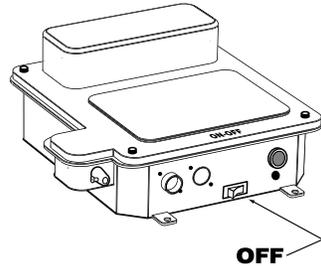

Step 15



Make sure the control box power switch is in the **OFF** position. Unscrew and remove the control box cover and slide the battery into position with its terminals to the **left** (see illustration). Push battery down until it fits snugly in control box. Connect the **BLACK** battery wire to the **NEGATIVE (-)** battery terminal. Connect the **RED** battery wire to the **POSITIVE (+)** terminal. Pay close attention to the color of the wires. If the wires are connected incorrectly, the control board will be damaged. **NEVER** insert the battery with the terminals to the right.

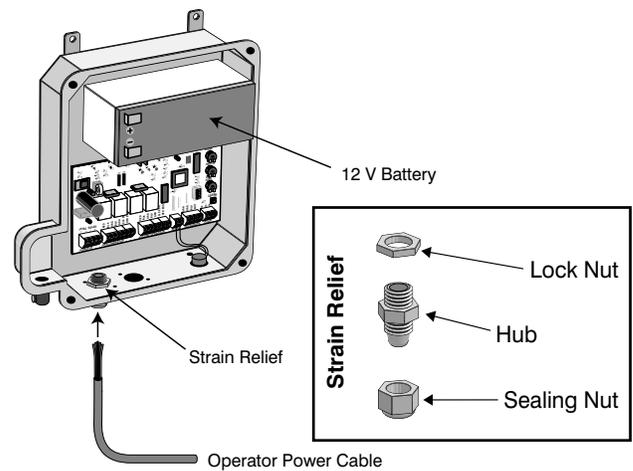
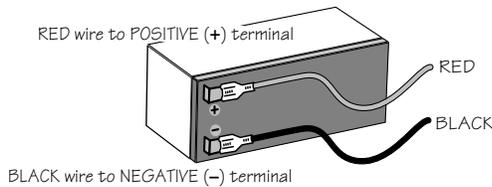

HINT: A dab of household petroleum jelly on the battery terminals will help prevent corrosion.

Step 16

Strip approximately $\frac{3}{16}$ " of insulation from each wire of the power cable. Twist each exposed wire tightly (there are five [5] wires inside the power cable sheath). Loosen sealing nut on strain relief hub at bottom of control box. Insert power cable into control box through strain relief. Thread approximately 4" of the power cable into the control box and retighten sealing nut until the power cable locks into place.

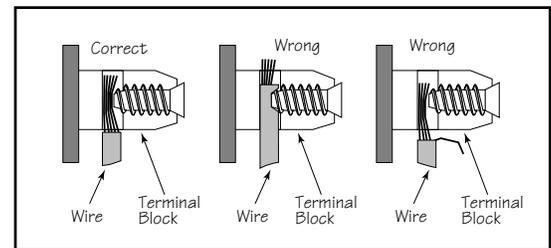
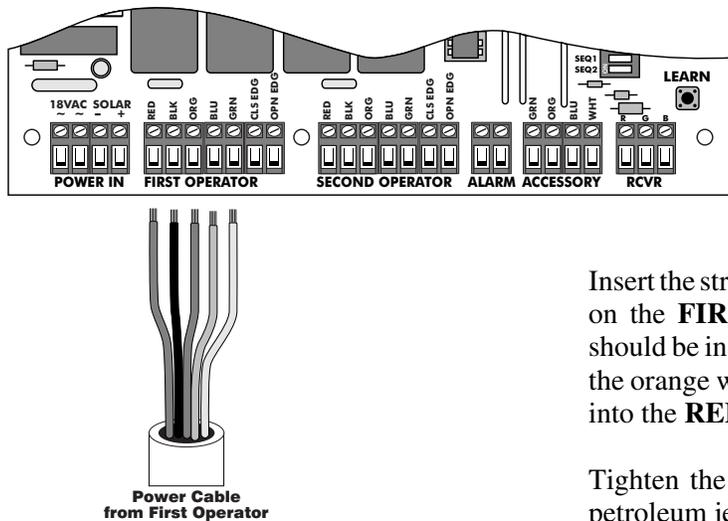

Insert the stripped power cable wires into the appropriate terminals on the **FIRST OPERATOR** terminal block. The green wire should be inserted into the **GRN** terminal, the blue wire into **BLU**, the orange wire into **ORG**, black wire into **BLK**, and the red wire into the **RED** terminal.

Tighten the set screws against the end of the wires. A dab of petroleum jelly on each terminal will help prevent corrosion.

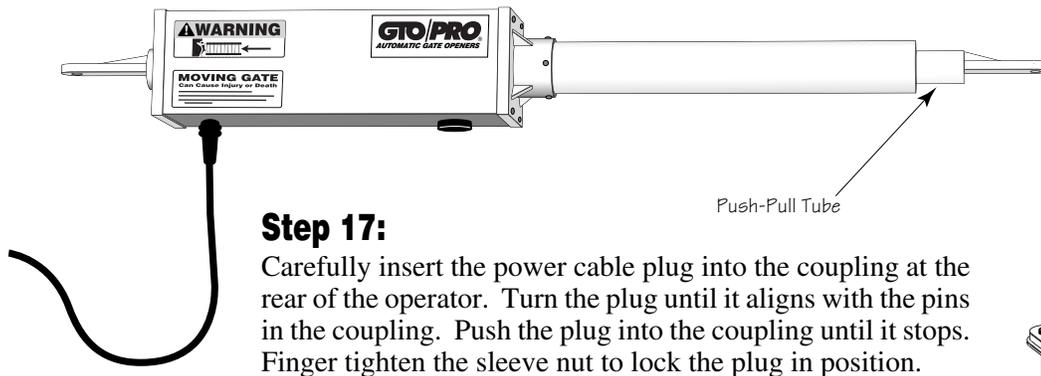

Step 17:

Carefully insert the power cable plug into the coupling at the rear of the operator. Turn the plug until it aligns with the pins in the coupling. Push the plug into the coupling until it stops. Finger tighten the sleeve nut to lock the plug in position.

Replace the control box cover and fasten it with (4) screws. Turn the control box power switch **ON**. The control board will energize in approximately 15 seconds.

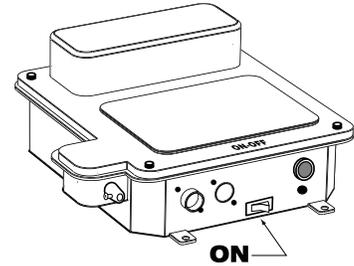

Setting The Closed Gate Position

Step 18:

Reattach front mount to gate bracket using clevis pin, washer, and hairpin clip. Press the transmitter to activate the operator and see how far the gate closes. The push-pull tube will initially extend only 7 1/2" until it is adjusted (maximum extension of operator is 11 1/2").

Step 19:

To increase the degree of gate closure, loosen the stroke adjustment knob on the bottom of the operator housing and move it about 1/8" towards the gate bracket (Fig A). **Finger tighten the knob.** (DO NOT USE PLIERS OR OTHER TOOLS TO TIGHTEN KNOB) Press the transmitter to check the closing distance. To decrease the degree of gate closure, move the stroke adjustment knob away from the gate bracket (Fig B).

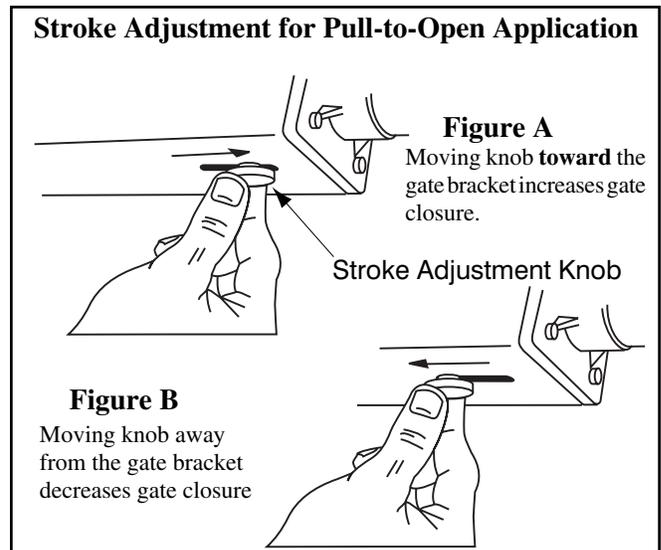

Step 20:

Repeat the procedure in Step 19 until the gate closes firmly as the operator motor shuts down. Each time you adjust the knob, finger tighten it before pressing the transmitter button to check your adjustment.

*If the push-pull tube has been extended too far (i.e., if the knob is too close to the gate bracket), the gate will immediately reverse and open after closing. When the knob setting is correct, the gate will close firmly, but not sharply, against the positive stop plate. The motor will run for one-half second after the gate closes against the stop plate. If the motor continues to run for more than one second, the push-pull tube is overextended and further adjustment is necessary. If the motor strains too long against the stop plate, the fuse on the control board (above **FIRST OPERATOR** terminal) will be blown. This blade-style 15 ampere fuse (sold by most automotive supply stores) can be easily replaced.*

NEVER use a fuse rated higher than 15 amperes!

Powering The System

IMPORTANT:

- The GTO transformer is intended for indoor use. If the transformer can only be plugged into an outside electrical outlet, a weatherproof housing or cover (available at local electrical supply stores) must be used.
- All low voltage wire for powering the GTO/PRO must be 16 gauge dual conductor, multi-stranded, direct burial wire (see *Accessory Catalog*). **Do not exceed 1000 ft. of wire.**
- If your gate is more than 1000 ft. from an ac power source you will need to use at least one (1) 5 watt Solar Panel; see *Accessory Catalog*. Also, refer to the Solar Panels and Gate activity chart below.

Solar Panels and Gate Activity

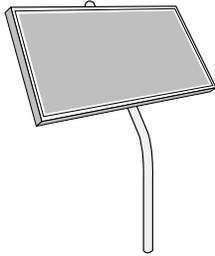

This table and map illustrate the maximum number of cycles per day to expect in a particular area, using GTO's 5 watt solar panels (see *Accessory Catalog*). Figures are shown for winter (*minimum sunlight*) and do not account for use of any

accessory items. Accessories connected to your system will draw additional power from the battery.

NOTE: GTO/PRO Dual Gate Systems REQUIRE A MINIMUM OF TWO (2) 5 W solar panels or ONE (1) 10 W panel for adequate charging power.

Winter Ratings	Zone 1	Zone 2	Zone 3
12 volt Single Gate (one 5 W panel)	4	8	13
12 volt Single Gate (two 5 W panels)	8	16	26
12 volt Single Gate (three 5 W panels)	11	20	30
12 volt Dual Gates (two 5 W panels)	4	8	13
12 volt Dual Gates (three 5 W panels)	7	13	20

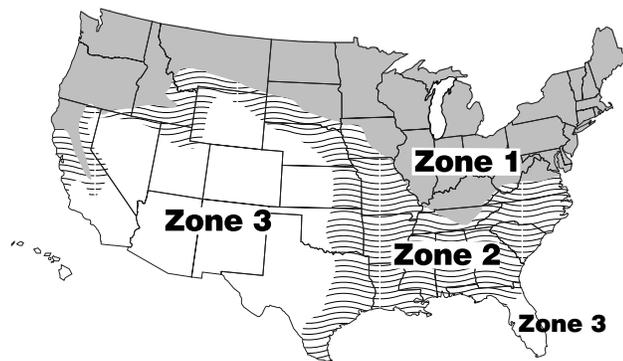

Connecting the Transformer

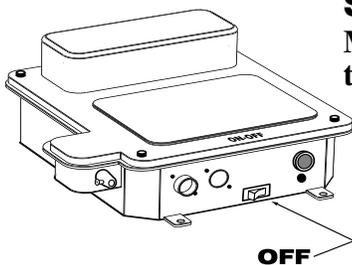

Step 21:

Make sure the power switch is OFF before proceeding to the next step.

Step 22:

Select the electrical outlet into which you will plug the transformer. Measure the distance from this electrical outlet to the control box following the path where the wire will be laid. After you have measured how much wire is needed, cut it to the appropriate length.

⚠ IMPORTANT INFORMATION ABOUT LOW VOLTAGE WIRE ⚠

The only wire acceptable for use with GTO products is 16 gauge multi-stranded, low voltage, PVC sheathed wire. This particular gauge enables the transformer to provide an adequate charge through the control board to the battery at distances up to 1000 ft.

DO NOT use telephone wire or solid core wire. Unlike multi-stranded wire, these types of wire are inadequate for use with your gate operator system. Telephone wire and solid core wire do not deliver enough voltage for your gate operator to function, and will cause the system to go into a condition known as "low voltage lockout."

Never splice wires together. Splicing permits corrosion and seriously degrades the wire's ability to carry an adequate current.

Step 23

Lay the measured length of low voltage wire in a trench following a path from the selected electrical outlet to the control box. Wires coming up from the ground should be run through PVC conduit to protect them from lawn mower blades, weed eaters, and grazing animals. Be sure to bury the wire laid in the trench.

Step 24

Feed the low voltage wires upward through the strain relief opening on the lower left of the control box. Pull 6" to 8" of wire into the control box and tighten the strain relief screw to secure the wires.

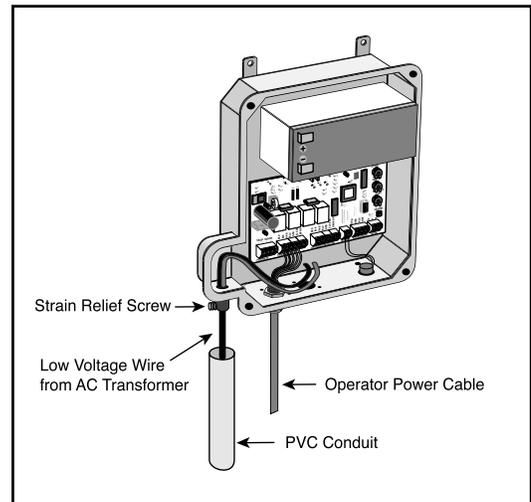

⚠ WARNING! DO NOT PLUG THE TRANSFORMER INTO AN OUTLET DURING THIS STEP. THE TRANSFORMER MUST ONLY BE PLUGGED INTO AN OUTLET DURING STEP 27!

Step 25

Strip $\frac{3}{16}$ " off the ends of the low voltage wire and twist tightly. Attach these ends to the **18VAC** terminals located on the **POWER IN** terminal block (see illustration at right). **Be certain not to let the exposed wires touch each other.**

Insert one transformer wire into an **18VAC** terminal. Insert the other transformer wire into the remaining **18VAC** terminal. The transformer wires can be connected to **18VAC** terminals regardless of color.

Tighten set screws against exposed end of wires. A dab of household petroleum jelly on each terminal will help prevent corrosion.

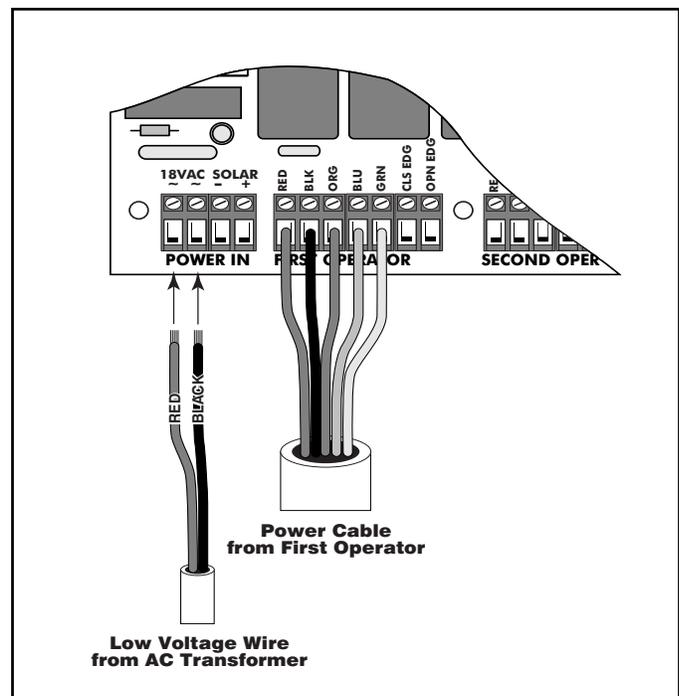
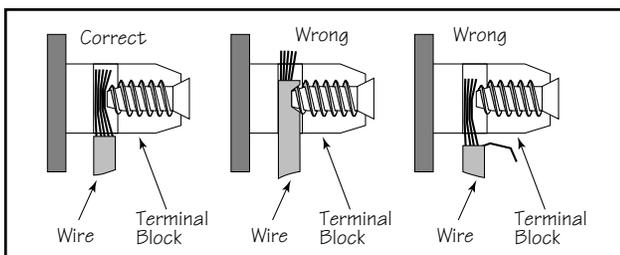

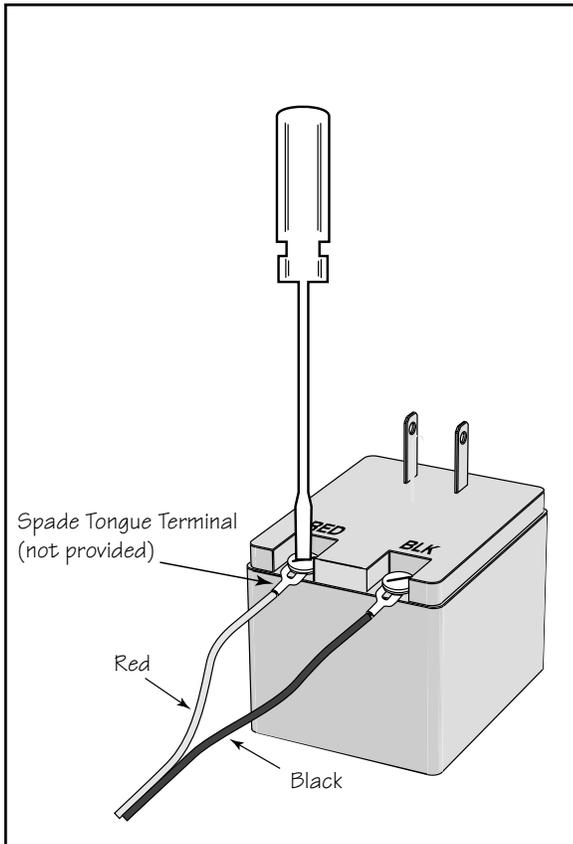

Step 26:

Strip 1/2" off the ends of the low voltage wire and attach ends to the transformer terminals; **red lead to (RED), black lead to (BLK).**

A dab of household petroleum jelly on each terminal will help prevent corrosion.

We suggest crimping a spade tongue terminal (*not provided*) to the end of each wire before attaching it to the transformer.

Be certain wire ends do not touch each other!

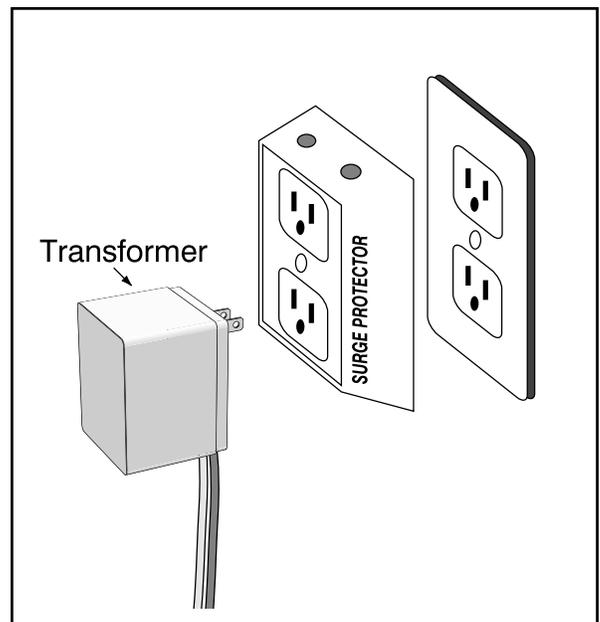

Step 27:

Plug in the transformer.

We strongly recommend using a surge protector.

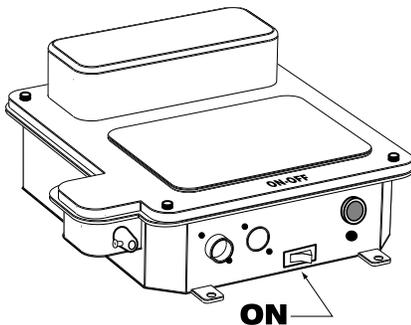

Step 28:

Turn control box **ON**.

HINT: keep a few mothballs in the control box to discourage insects from entering it and damaging the control board.

CONTROL BOARD SETTINGS

DIP switches

The four DIP switches on the control board match the operator with the type of gate on which it is mounted. For example, gates may pull-to-open or push-to-open. Prior to packaging, the GTO/PRO 1000 control board was configured for single swing gates that pull-to-open (open *into* the property). If your gate type matches this configuration, you **DO NOT** need to adjust the DIP switches; proceed to the **Potentiometers** section on the next page.

NOTE: To change the DIP switch settings, you must turn the control box power switch OFF; move the switch; then turn the power back ON. Use a small screwdriver to move the switches.

PULL/PUSH: Set to **PULL** for swing gates that pull-to-open [factory setting]; **PUSH** for swing gates that push-to-open (see **Push to Open Installation** on pages 30-31).

NOTE: The direction a gate opens is determined by standing inside the property and facing toward the gate.

SNGL/DUAL: Set to **SNGL** for a single gate leaf [factory setting]; **DUAL** for dual gate leaves.

SEQ1: Controls the opening order of dual gate leaves.

See **Setting the Control Board for Dual Gate Installations** on page 39 for more information. (the factory setting is OFF).

SEQ2: Controls the opening order of dual gate leaves.

See **Setting the Control Board for Dual Gate Installations** on page 39 for more information. (the factory setting is OFF).

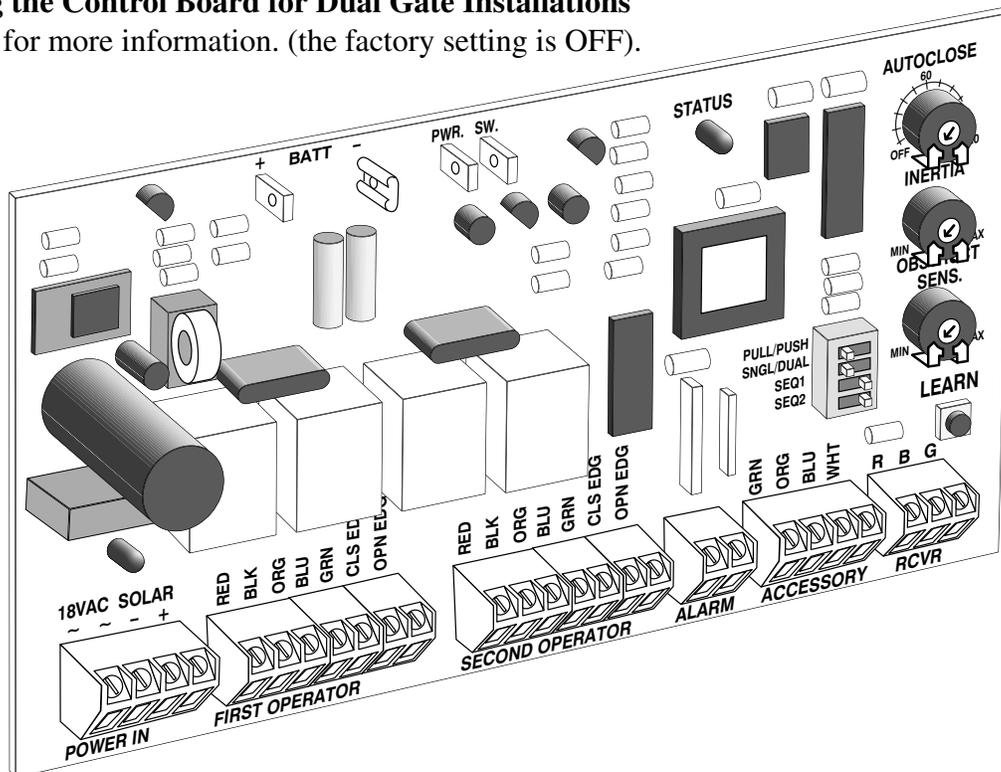
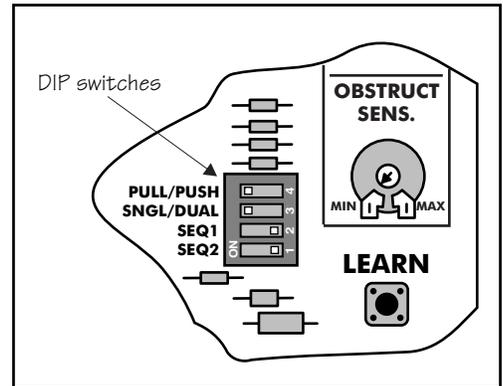

Potentiometers

The three (3) potentiometers on the control board operate like a volume control on a radio. They control the auto close timer, inertia, and obstruction sensitivity of the operator. Use a small slotted screwdriver to turn the arrow in the center of the potentiometer. Clockwise rotation increases the setting (**MAX**). Counterclockwise rotation decreases the setting (**MIN**).

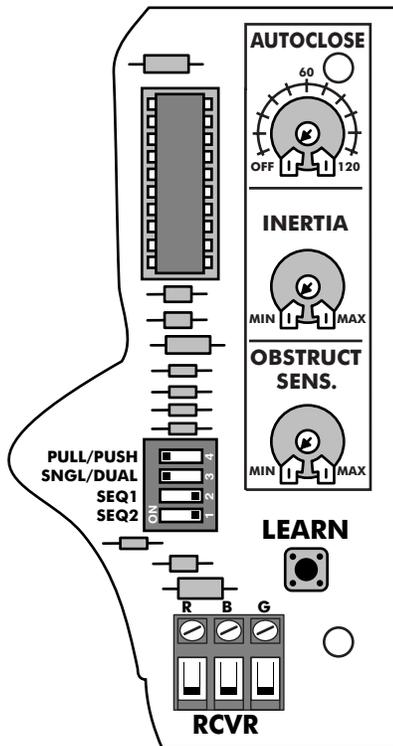

AUTO CLOSE (auto close timer): Determines how long the gate will remain open before it automatically closes. The limits are **OFF** to 120 seconds. The factory setting is **OFF**.

INERTIA: Fine tunes obstruction sensitivity in the opening and closing modes. **INERTIA** allows the operator to attempt to push an obstruction clear of the gate path. When **INERTIA** is set to **MIN** the operator will obstruct *quickly* (i.e., will attempt to push an obstruction briefly); when set to **MAX**, the operator will obstruct *slowly* (will attempt to push against an obstruct for a longer period). The factory setting is **MIN**.

OBSTRUCT SENS. (obstruction sensitivity): Determines the amount of *force exerted by the gate* on an obstruction before the operator stops and reverses. The gate will exert *minimum force* before obstructing when set to **MIN**. When set to **MAX**, the operator will exert *maximum gate force* before obstructing (i.e., the operator will require greater resistance before stopping and reversing.). The factory setting is **MIN**.

READ WARNING BELOW!

NOTE: Heavy gates and gates with high wind resistance *may* require the **OBSTRUCT SENS.** potentiometer to be set closer to **MAX** to prevent the operator from obstructing. Keep in mind, however, that while you must determine the best setting for *smooth* gate operation, you must ALSO determine the lowest possible setting for *safe* gate operation.

ALWAYS KEEP SAFETY AT THE TOP OF YOUR LIST WHEN ADJUSTING OR SERVICING YOUR AUTOMATIC GATE OPERATOR!

⚠ WARNING! ⚠

All three potentiometers were set to minimum at the factory. The **OBSTRUCT SENS.** potentiometer **MUST** be adjusted above the factory setting for your **GTO/PRO 1000 series** operator to function properly. If the potentiometer is left at **MIN**, your gate operator may "obstruct" (i.e., stop and reverse) as soon as it is activated.

BE SURE TO PROPERLY RETEST THE GATE OPERATOR AFTER MAKING ANY ADJUSTMENTS; FAILURE TO DO SO MAY RESULT IN SERIOUS INJURY OR DEATH.

Setting Your Personal Transmitter Code

All GTO transmitters are set to a standard code at the factory and are ready to activate your automatic gate operator. For your safety and security, however, we **strongly recommend** that you replace the factory setting with your own personal code. Follow the directions below:

1. Remove the Transmitter Cover

Grasp the sides of the access cover and slide it away from the transmitter button (see illustration). When the access cover is removed, the battery and the DIP switches will be exposed. To set a new code, use a small screwdriver to move the switches.

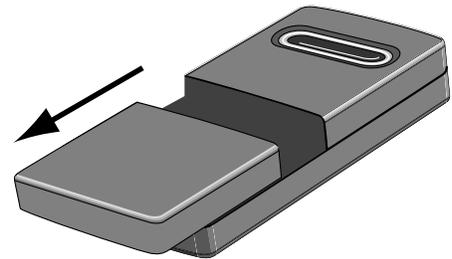

2. Set the transmitter DIP Switches

There are nine (9) transmitter DIP switches; each of which can be placed in three different positions (+, 0, -). **DO NOT** set all the switches in the same position, such as all +, all 0, or all -. Once the DIP switches have been set to a personal code, replace and close the access cover.

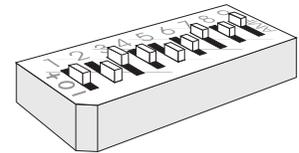

WARNING: No other adjustments should be made inside the transmitter.

3. "Teach" the New Code to Control Board Memory

- Turn control box power switch **OFF**.
- Unscrew and remove the control box cover.
- Press and hold the **LEARN** button on the control board, and turn the power switch **ON**. Release **LEARN** button. Wait 15 seconds for the receiver to charge.
- Press and hold transmitter button until the red **STATUS** LED comes **ON**.
- Release transmitter button. The new code is stored in control board memory.

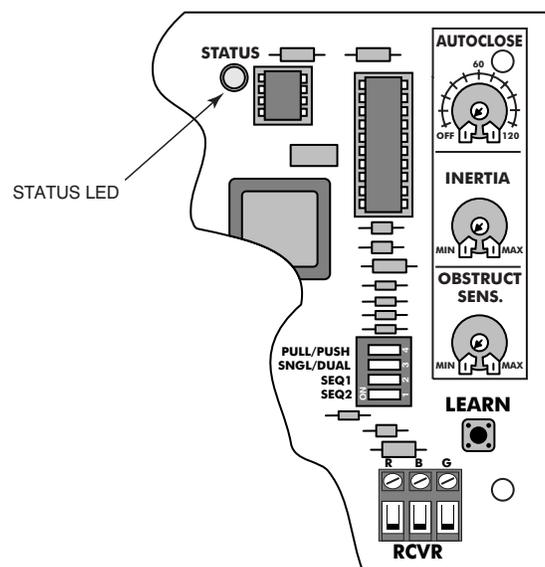

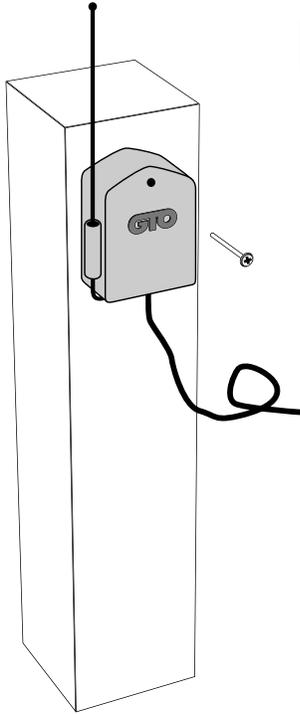

Mounting the Receiver

Use the transmitter to check the range of the receiver before permanently mounting it.

Consider the following when mounting the receiver:

- Receiver cable length is 10 feet (receivers with a longer cable are available as special order items; *call the GTO Sales Department*). NEVER splice receiver cable!
- **Run the cable through PVC conduit to protect it from damage.**
- DO NOT run cable through metal conduit because the receiver signal range will be decreased.
- DO NOT run cable in a conduit containing ac wiring.
- DO NOT mount receiver on a metal fence or post— doing so will decrease signal range.
- DO NOT overtighten the mounting screws; the receiver housing could be warped and the weather seal damaged.
- The receiver range can vary from 50 to 100 feet depending upon weather, topography, and external interference.

FCC Regulation

This device complies with FCC rules Part 15. Operation is subject to the following conditions:

1. This device may not cause harmful interference.
2. This device must accept an interference that may cause undesired operation.

Transmitter distance may vary due to circumstances beyond our control. **NOTE: The manufacturer is not responsible for any radio or TV interference caused by unauthorized modifications to this equipment. Such modifications could void the user's authority to operate the equipment.**

Connecting Additional Safety Devices

The GTO/PRO 1000 series operators are equipped with built-in obstruction sensitivity. The operator is designed to stop and reverse the gate for 2 seconds when it comes in contact with an obstruction. However, obstruction sensitivity, even when properly adjusted, *may not be sensitive enough to prevent bodily injury in some circumstances*. To augment your protection against entrapment, GTO *suggests* using safety edge sensors or photoelectric sensors. When installed, safety edges (or photoelectric sensors) must be mounted in compliance with UL 325, Underwriters Laboratories safety standard for gate operators. Review page 4 for information about mounting requirements for safety edges ("contact sensors") and photoelectric sensors ("non-contact sensors").

Refer to the sensor manufacturer's instructions for information about installing these devices on a vehicular gate.

⚠ Make sure the control box power switch is OFF before connecting safety device wiring to the terminal blocks.

Insert the safety device wires into the **CLS EDG** terminal (located on the **FIRST OPERATOR** terminal block) for the gate closing mode. Connect the safety device ground wire to the **GRN** terminal. Connect the safety device wires for the gate opening mode to the **OPN EDG** terminal in the same manner.

If you are installing a dual gate system, connect the safety device wires to the **CLS EDG** and **OPN EDG** terminals on the **SECOND OPERATOR** terminal block as described above.

⚠ MAKE SURE TO GROUND THE SAFETY DEVICES AT THE GRN TERMINAL! THE CONTROL BOARD COULD BE DAMAGED IF THE SAFETY DEVICES ARE NOT GROUNDED!

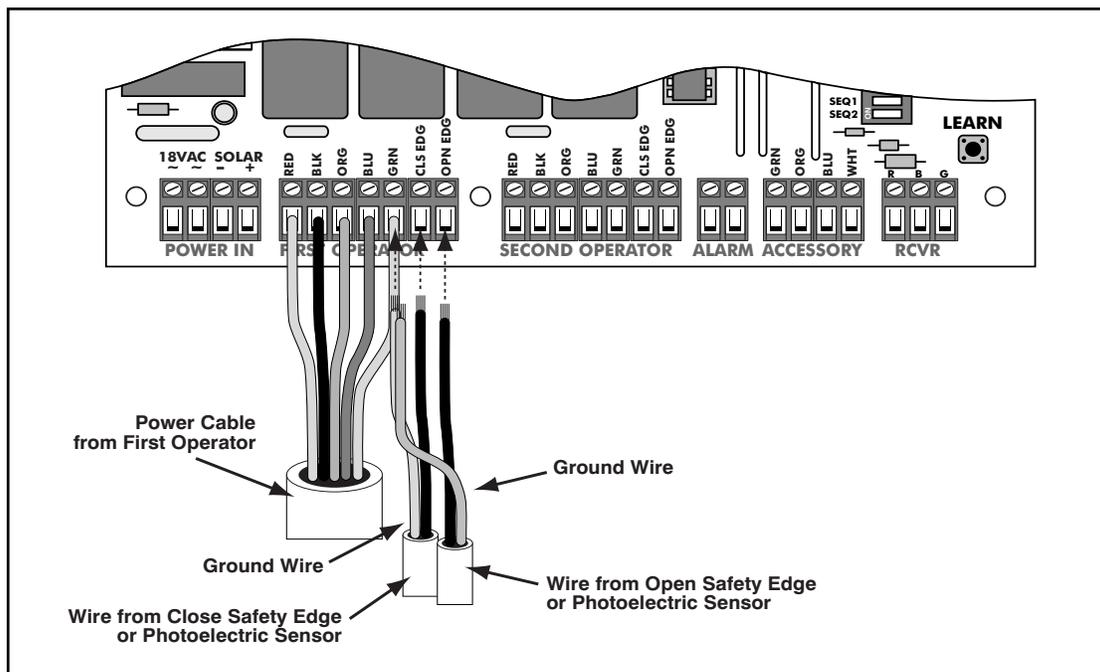

PLEASE NOTE: Safety edge sensors and photoelectric sensors are neither *included with* nor *required for* the GTO/PRO 1000 series gate operators.

Compatible Safety Devices

Although GTO **strongly recommends** the use of safety devices, we do not endorse any specific brand names. Below is a list of some products compatible with GTO operators systems, some of which require their own power supply. Check with the individual manufacturer for specific power needs.

Only use products that are certified and listed to be in compliance with national and regional safety codes.

Safety Edges

Miller Edge, Inc.

MC-22
ME-110 through 113
ME-120
ME-123
MG-020
MT-21 and 22
MU-22

Tapeswitch Corporation

101-B and BMT
102-A, B, BP, BPH
107-RS and LS
121-BP
131-A and AMT
141-BMH
191-S
IL

Photoelectric Beams

Texas Optoelectronics, Inc.

Industrial Photobeam

EMX Industries, Inc.

IRB-4X

NOTE: This is not an exhaustive list of compatible safety devices.

Connecting Accessories

⚠ Make sure the control box power switch is OFF before connecting accessories.

The ACCESSORY terminal block is the connection point for accessories such as push buttons, safety loops, intercoms, etc. The ACCESSORY terminal marked GRN (green) is the common ground for all accessories. GRN is paired with the terminals shown below when connecting accessories to the control board.

IMPORTANT: Make sure to twist exposed wires tightly and insert them into the terminals without loose strands. Tighten set screws against exposed end of wires. A dab of household petroleum jelly in each terminal will help prevent corrosion.

WHT (white) used with GRN (green):

Functions as a normally open contact. This is the most frequently used pairing for a doorbell button, keypad, or key switch.

- First contact will start the gate.
- Second contact will stop the gate.
- Third contact will reverse the gate.

NOTE: *Never use a lighted doorbell button!* It will discharge the battery and the gate operator will fail to operate.

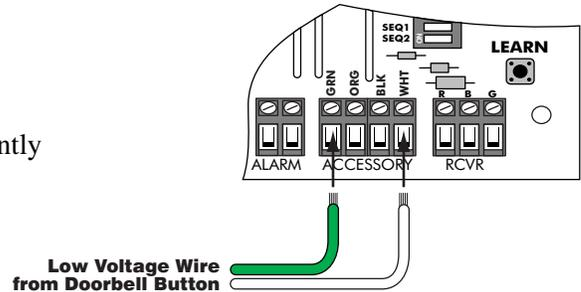

BLU (blue) used with GRN (green):

Functions as a normally open contact. This pairing is typically used for free entry and free exit devices.

- First contact will open the gate.

NOTE: If the gate is in the open position and begins to close, the activation of the accessory device will reopen the gate. In communities where the use of an emergency entry device is mandatory, it should be connected to these terminals.

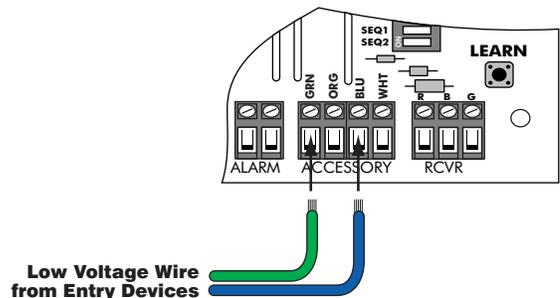

ORG (orange) used with GRN (green):

Functions as a normally open contact. This pairing is frequently used for safety loops.

This connection will not open your gate. The safety loop will activate *only while the gate is in use*. When using this combination, the gate will remain open or reopen if it is closing.

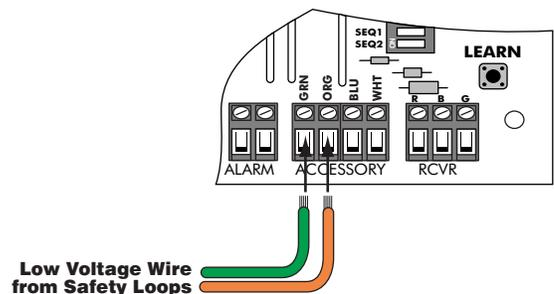

Push to Open Installation

Determining The Mounting Position of The Post Bracket Assembly

⚠ Swinging gates shall not open into public access areas!

A "Push-to-Open" gate opens *out* from the property. A **Push-to-Open Kit** is required for this type of installation (see *Accessory Catalog*). If you have a pull-to-open gate (gate opens *into* the property), return to page 12; step 5.

The operator is installed while the gate is in the **closed** position.

Step PTO-1:

With the gate **closed**, adjust the post bracket assembly and the gate bracket until the operator is level. While holding the operator level, use C-clamps to temporarily keep these parts in their respective positions on the fence post and gate.

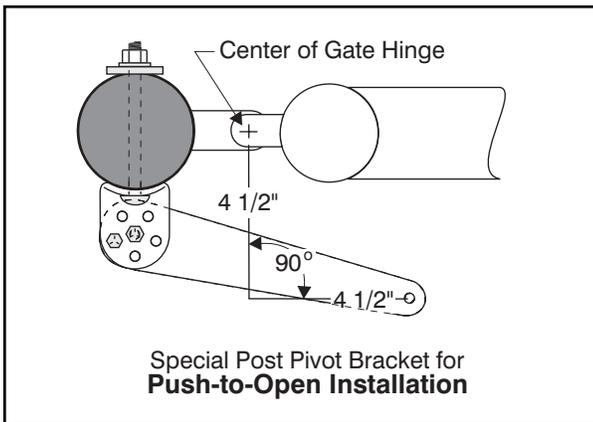

Step PTO-2:

While gate is closed, stand inside the gate next to the fence post. Using the **setback template** (*insert*) measure 4 1/2" back from center of hinge, then make a 90° angle toward the gate and measure 4 1/2". This is the point where either one of the holes at the end of the post pivot bracket should be. You will need to rotate the post pivot bracket or the entire post bracket assembly to align it with the square angle of the template.

NOTE: When you move the post pivot bracket, be sure one of the post bracket holes is aligned with the rest of the assembly (center hole should already have bolt through it).

Flipping the Post Pivot Bracket gives more position options.

After verifying that you have complied with the 4 1/2" x 4 1/2" setback, insert the 5/16" x 1 3/4" bolt through the aligned holes of the post bracket and post pivot bracket and fasten it with the 5/16" washer and nut.

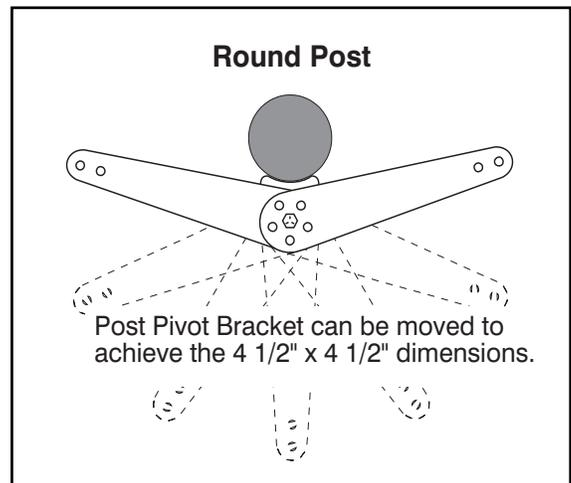
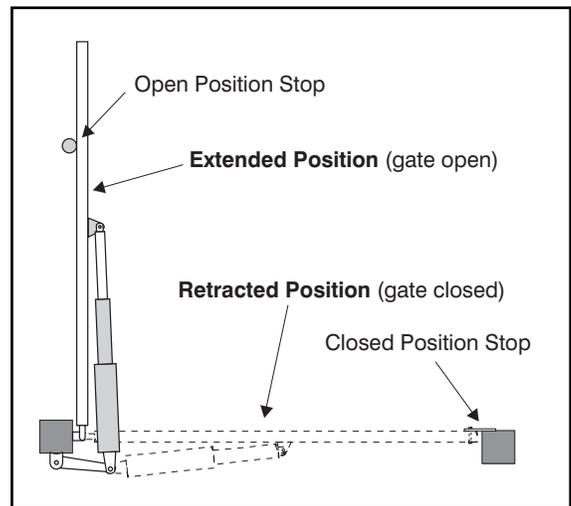
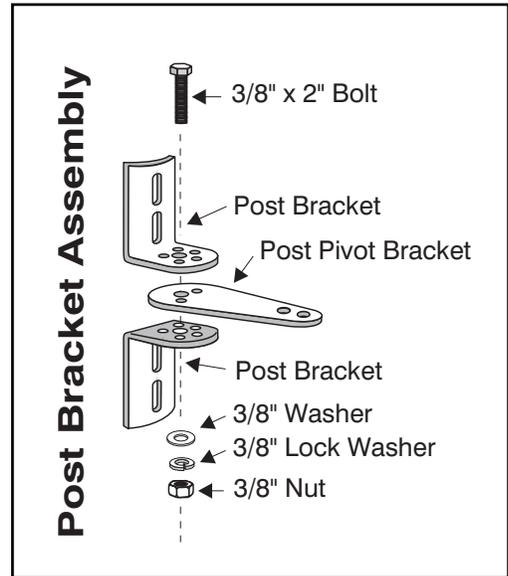

Step PTO-3:

With the gate in the **fully closed position** and the operator retracted, swing the operator to the gate. Mark reference points for bolt holes on gate cross member through middle of gate bracket slots. The operator must be level. (Some vertical adjustment is possible by sliding the post bracket assembly up and down.) Drill $\frac{3}{8}$ " holes into the gate cross member as marked. Fasten gate bracket to cross member using (2) $\frac{3}{8}$ " x 3" bolts, washers, lock washers and nuts. Attach the operator to the post bracket assembly and gate bracket using clevis pins, washers, and hairpins clips.

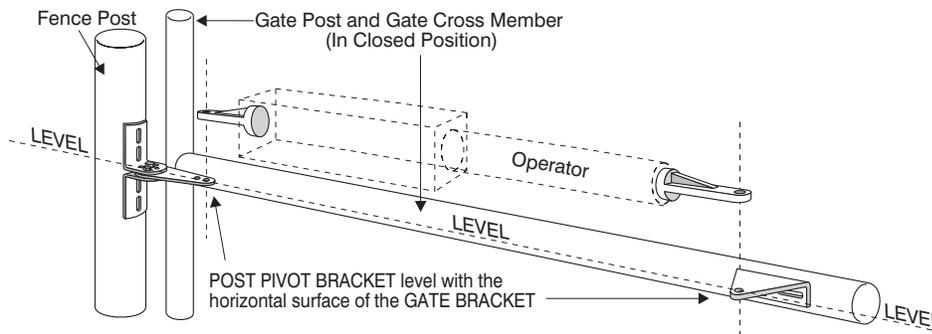

Step PTO-4:

Make sure the control box power switch is **OFF**. Use a small screwdriver to move the **PULL / PUSH** DIP switch to **PUSH**. Replace control box cover. Turn power switch **ON**. The control board is now configured to *push* the gate open.

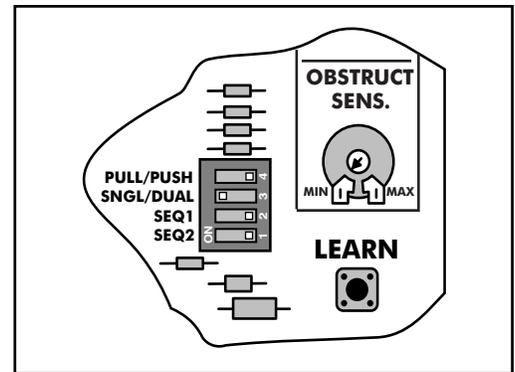

Step PTO-5:

Press the transmitter to activate the operator and determine the degree of gate opening. Initially, the operator will extend only 7" to 8" until it is adjusted (the maximum extension of operator is 11 $\frac{1}{2}$ ").

Step PTO-6:

To *increase* degree of gate opening, loosen the **stroke adjustment knob** on the bottom of the operator housing and move it about $\frac{1}{8}$ " toward the gate bracket (see Fig. A). **Finger tighten the knob—DO NOT USE PLIERS OR OTHER TOOLS TO TIGHTEN KNOB**. Press the transmitter to check your adjustment. To *decrease* the degree of gate opening, move the stroke adjustment knob away from the gate bracket (see Fig B).

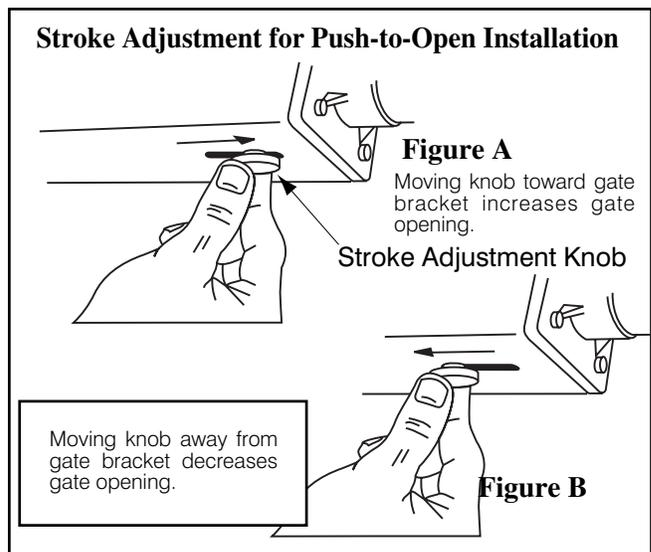

Step PTO-7:

NOTE: Each time you adjust the knob, finger tighten it before pressing the transmitter button to check your adjustment.

Repeat the procedure in step PTO-6 until the gate stops firmly (but not sharply) against the open position stop plate. The motor will continue to run for one-half second after the gate opens against the stop plate. If the motor continues to run for more than one second, the operator is overextended and further adjustment is necessary. If the motor strains too long against the stop plate the fuse on the control board (for the **FIRST OPERATOR** terminal) will be blown. This blade-style 15 ampere fuse (sold by most automotive supply stores) can be easily replaced.

NEVER use a fuse rated higher than 15 amperes!

Maintenance and Troubleshooting Guide

If your gate operator does not function properly after it is installed, use this guide before calling the GTO Service Department.

- On all gates weighing 250 lb. or more, routinely grease the ball bearing hinges at least 4 times a year; more frequently if the gates are near a coastal area.
- Keeping a few mothballs in the control box will discourage insects from entering it and damaging the control board.
- Clean the push-pull tube with a soft, dry cloth and apply silicone spray to it at least once per month.

If the Operator Does Not Work

Check the Green LED on the Control Board:

IF THE LED IS OFF- This condition indicates a transformer power failure.

1. Test the transformer for voltage with a voltmeter. The acceptable range can be found in the **VOLTAGE LIMITS** chart on the next page. If the transformer test shows no voltage, then test the electrical outlet for voltage. If the outlet test shows voltage, then the transformer is dead and must be replaced. Allow the new transformer 12 hours to charge the battery before using the gate operator.
2. If the transformer test shows voltage, check the **POWER IN** terminal block on the control board for voltage. If the terminal block shows no voltage, look for broken or spliced wires.

Check the Red STATUS LED on the Control Board:

IF THE LED IS ON—but the unit is not working

1. Check the battery in your transmitter and replace with a fresh one if needed.
2. Verify that the power cable is securely connected.
3. Replace the control board fuse if it is blown (**15 ampere fuse only - DO NOT USE A HIGHER RATED FUSE!**).

IF THE LED IS OFF—

1. Make sure the **ON / OFF** switch at the bottom of the control box is set to **ON**.
2. Check all connections for looseness and corrosion.

IF THE LED IS FLASHING—

The system may be in a condition known as "**low voltage lockout**" (i.e., inadequate voltage supplied for the gate operator to function.

1. Test (using a voltmeter) the voltage output of the transformer (18.0 to 22.0 Vac) or solar panel (18.0 to 22.0 Vdc) at the control board power terminal block.
 - A. If the voltage is low or not reading, load test the battery at a electronics store and call your dealer for a replacement battery if necessary.
 - B. If the voltage is low or not reading, test the transformer and electrical outlet. Replace the transformer if necessary and let the battery recharge for 12 hours before using the gate operator.
 - C. Check the control board for damage or corroded connections.
 - D. Make sure that telephone or solid core wire is *not* being used to connect the transformer to the control board.

If the Operator is Working

The Gate CLOSSES Then Opens Again on its Own:

1. Check the position of the mounting brackets and readjust if necessary.
2. Check the gate for binding or hinge damage.
3. Check the position of the stroke adjustment knob.

The Gate OPENS Then Closes Again on its Own:

1. Check the position of the mounting brackets and readjust if necessary.
2. Check the gate for binding or hinge damage.
3. Check the position of the stroke adjustment knob.

VOLTAGE LIMIT CHART

18 Vac Transformer _____	18.0 to 22.0 Vac
5 W Solar panel (single) _____	18.0 to 22.0 Vdc 300 mA
measure voltage at panel and control box.	
12 V Battery _____	12.0 to 13.5 Vdc 7.0 Ah
Charging circuit _____	12.0 to 14.8 Vdc
measure voltage with battery connected	

The **GTO, Inc. Technical Service Department** is open
Monday – Thursday 7:30 A.M. – 5:30 P.M.
and Friday 8:00 A.M. – 12:00 P.M. (Eastern Time)

Telephone (800) 543-1236

Telephone (850) 575-4144

Fax (850) 575-8950 • Web site: www.gtoinc.com

E-Mail: techsupport@gtoinc.com

Warranty and Repair Service

If the GTO gate operator system is not operating properly, please follow the steps below:

1. First, check the Troubleshooting Guide (*see page 32*).
2. Call your dealer or installer for assistance.
3. If your dealer or installer is unable to resolve the problem, call the GTO Service Department at (850) 575-4144 to discuss the problem with a service technician. Refer to the serial number (located on the control box cover) and date of purchase when calling for assistance.
4. If repair or replacement is necessary, you will be assigned a **Return Goods Authorization Number (RGA)**.
5. Carefully pack the component(s) authorized for return and ship freight prepaid to:
GTO, Inc., 3121 Hartsfield Road, Tallahassee, Florida, USA 32303.

NOTE: GTO products returned **without an RGA Number** (on the outside of package in **LARGE BOLD PRINT**) or **shipped freight collect WILL NOT** be accepted by the factory.

6. If the repair service or replacement *is covered by warranty*, GTO, Inc. will pay shipping costs (equal to United Parcel Service ground rate) for return to owner.

GTO/PRO[®] **AUTOMATIC GATE OPERATORS** **Limited Two Year Warranty**

GTO/PRO 1000 series automatic gate operators are warranted by the manufacturer against defects in materials and manufacturer workmanship for a period of two (2) years from the date of purchase, *provided recommended installation procedures have been followed.*

In the case of product failure due to defective material or manufacturer workmanship within the two (2) year warranty period, the operator will be repaired or replaced (at the manufacturer's option) at no charge to the customer, *if returned freight prepaid to GTO, Inc., 3121 Hartsfield Road, Tallahassee, Florida, USA 32303. IMPORTANT: Call (850) 575-4144 or Fax (850) 575-8950 for a Return Goods Authorization (RGA) number before returning to factory.* Products received at the factory without an RGA number will not be accepted. Replacement or repaired parts are covered by this warranty for the remainder of the two (2) year warranty period or six (6) months, whichever is greater. GTO will pay the shipping charges (equal to United Parcel Service ground rate) for return to the owner of items repaired under warranty.

The manufacturer will not be responsible for any charges or damages incurred in the removal of the defective parts for repair, or for the reinstallation of those parts after repair. This warranty shall be considered void if damage to the product(s) was due to improper installation or use, tampering, connection to an improper power source, or if damage was caused by lightning, wind, fire, flood, insects or other natural agent. This warranty gives you specific legal rights, and you may also have other rights which may vary from state to state. This warranty is in lieu of all other warranties, expressed or implied. **NOTE: Verification of the warranty period requires copies of receipts or other proof of purchase. Please retain these records.**

After the two (2) year warranty period has expired, GTO or one of its authorized service centers will make necessary repairs for a nominal fee. Call GTO at (850) 575-4144 for more information.

Column Installation Information

READ THE FOLLOWING CAREFULLY BEFORE INSTALLING THE GTO/PRO 1000 AND GTO/PRO 1200 ON GATES THAT ARE MOUNTED ON COLUMNS MADE OF MASONRY, BRICK, ROCK, etc.

Attaching a gate operator to a gate mounted on a masonry column requires special procedures.

Here's how to check your installation to minimize problems:

Open the gate to the 90° position, then measure the distance between the back of the gate and the face of the column. If there is at least a 6 1/4" clearance, you *may not* have to make any special modifications. However, you *must* measure the post pivot bracket position using 4 1/2" x 4 1/2" setback, as described on page 13 of this manual, to verify that the gate hinge sits far enough from the column to give your installation the proper setback distance.

If you do not have the proper clearance or setback distance, the operator may operate the gate for a while, but eventually the unit will become nonfunctional. To prevent this problem, we suggest the following installation method:

- A. The simplest solution is to install the operator in a push-to-open configuration (push-to-open bracket(s) are required; see accessories on page 43). The crucial 4 1/2" setback is actually easier to achieve this way and clearance is no longer a problem, since the operator will be pushing the gate away from the column instead of pulling it toward the column. It is recommended that you place a steel plate between the operator mounting brackets and masonry surface for additional strength.
- B. If a push-to-open option is impossible due to traffic hazards, terrain, etc., another option is to re-hang the gate. You might hang it on a post, either in the center of the column or at the back corner, or move the gate to the back corner of the columns.
- C. The most difficult solution is to notch a pocket in the column to accommodate the operator and power cable. This is not a job for the inexperienced!

GTO/PRO Dual Gate System Installation

Second Unit Parts List

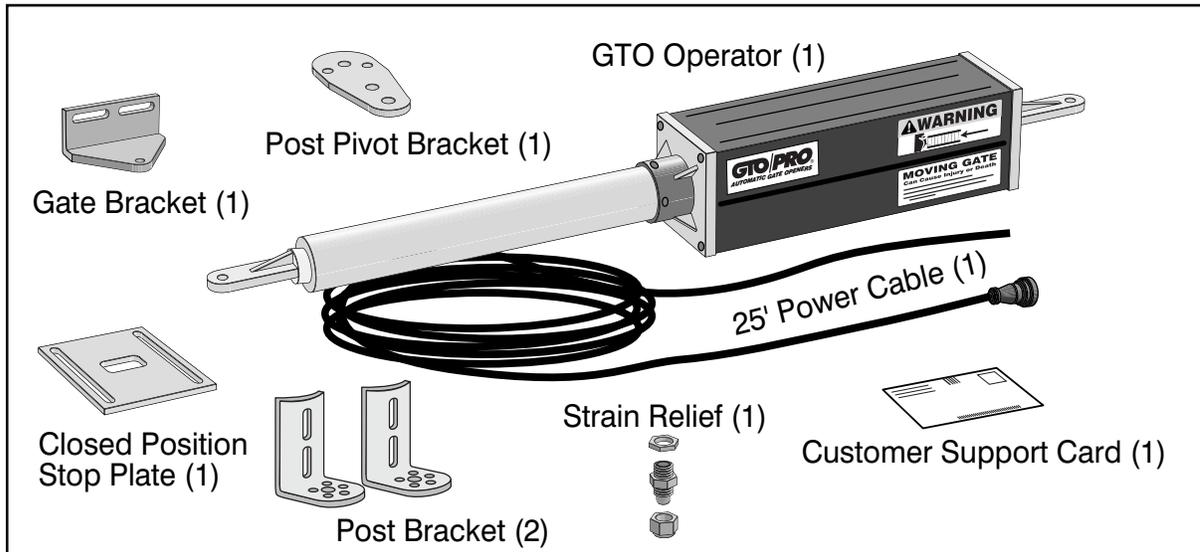

8" Nylon Cable Tie (6)

Hardware (Actual Size)

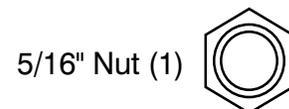
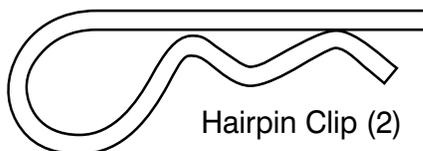
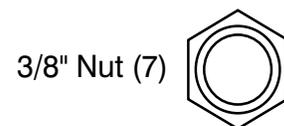
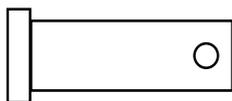
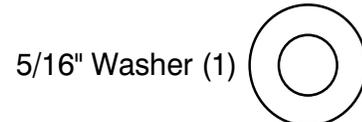
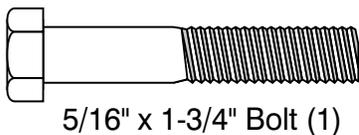
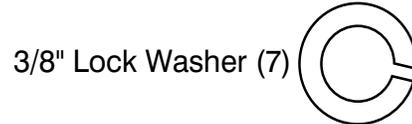
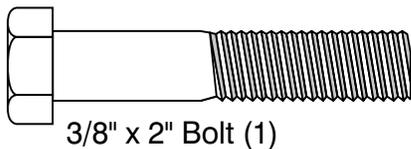
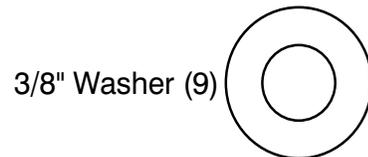
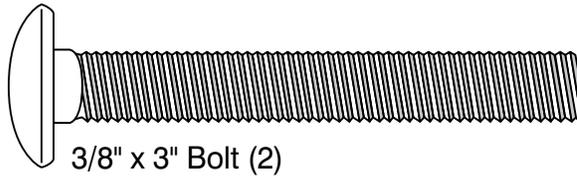
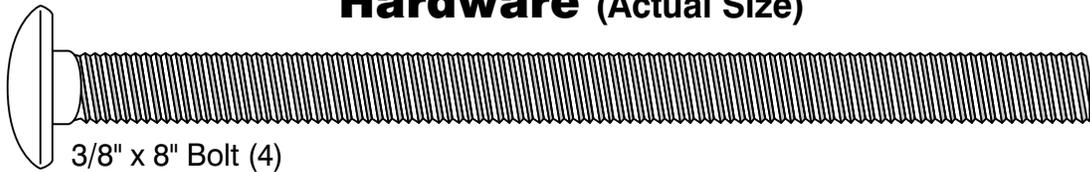

Installing the Second Unit

The diagram below is of a dual gate, pull-to-open (open-in) installation on a chain link fence and gates. "Pull-to-Open" dual gates open into the driveway. **If you are installing a "Push-to-Open" gate system see "Push-to-Open Installation" starting on page 30.**

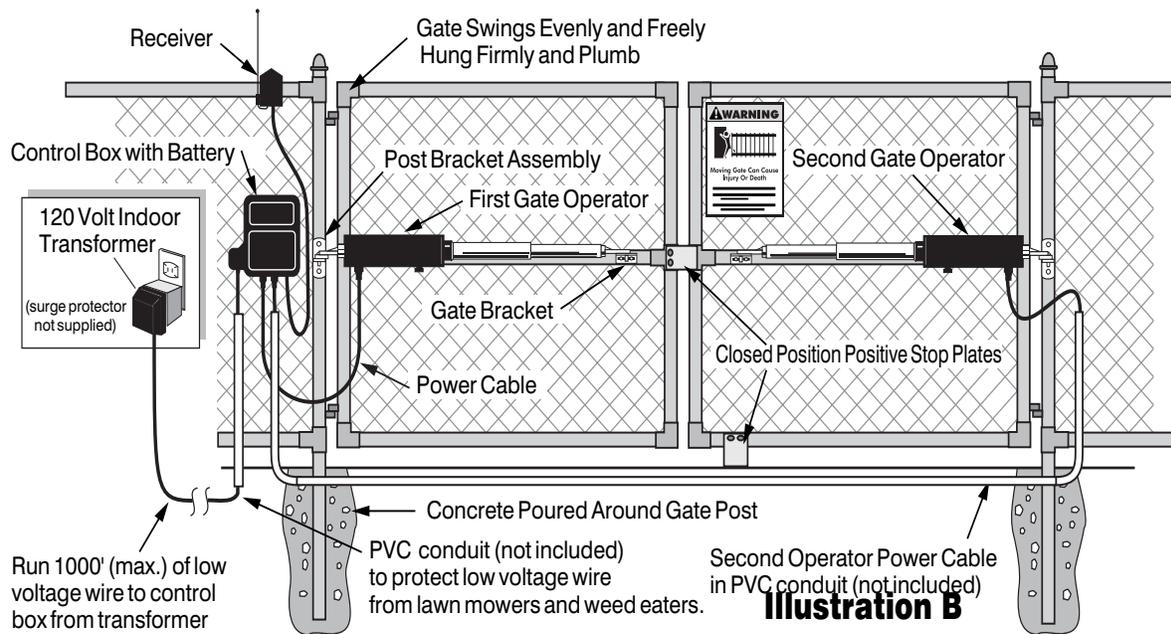

Run 1000' (max.) of low voltage wire to control box from transformer (wire not included).

Step D-1:

Turn back to page 11 and repeat Steps **1 through 11** to install the second unit.

Step D-2:

Install open position stops for both gates. See Step 12, page 16.

Step D-3:

Remove the hairpin clips, clevis pins, and washers from the operators and close the gates. Install the closed position stop plate on the gate that you want to **close second**. Extend the stop plate to make contact with the leading edge of the other gate.

Step D-4:

A dual gate system requires a closed position positive stop for the gate that **closes first**. Install a closed position positive stop in driveway directly below the gate (see illustration at right).

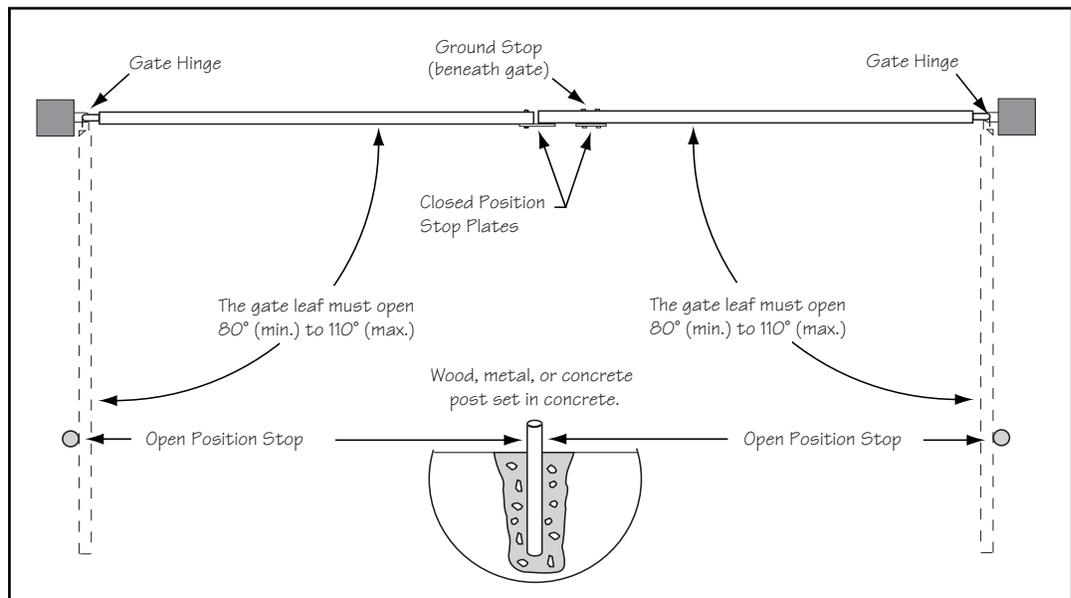

Step D-5:

Attach the closed position stop plate vertically to the inside bottom of the gate that will close first. When the gate is in closed position, the positive stop plate should rest against the ground stop installed in Step D-4.

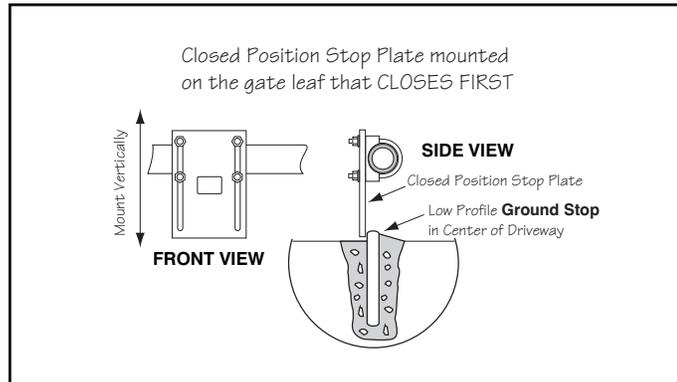

Connecting the Second Operator to the Control Board

Step D-6:

Turn power switch OFF. Remove the control box cover. Using a steel punch or screwdriver, remove the thin plastic knockout in the second operator connector hole at the bottom of the control box. **Work from the inside out to avoid damaging the control board.**

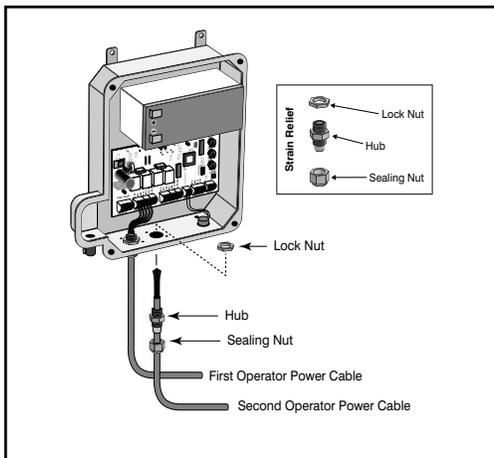
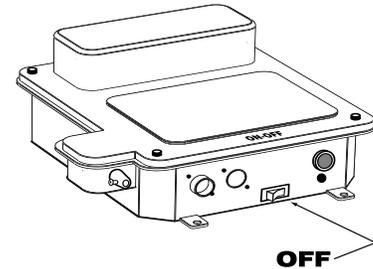

Step D-7:

Insert the strain relief into the knockout hole and finger tighten it in the control box. Insert the stripped end of second operator cable up through bottom of strain relief (if necessary, loosen the strain relief). Pull approximately 4" of wire into the control box and retighten the strain relief on the black sheath of the power cable.

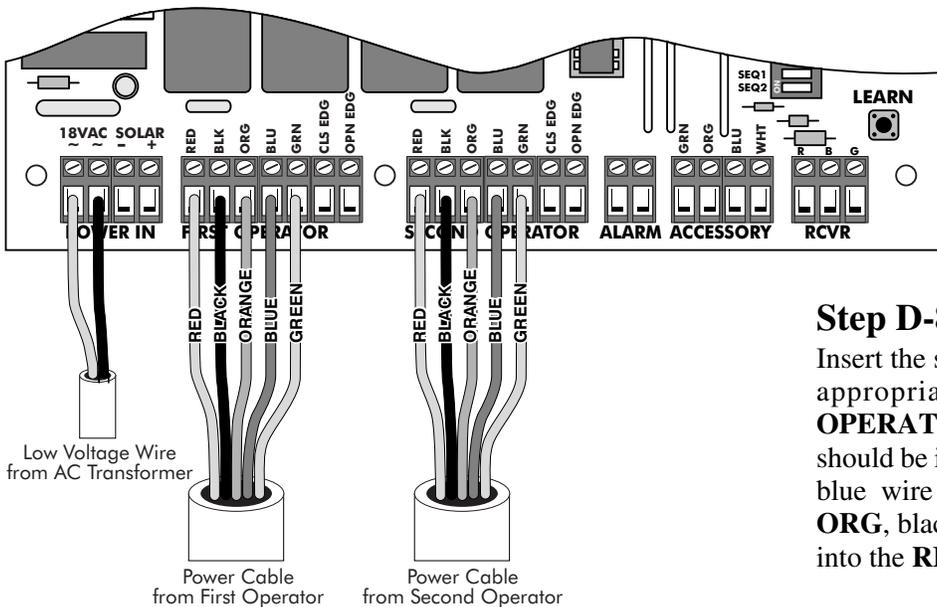

Step D-8:

Insert the stripped power cable wires into the appropriate terminal on the **SECOND OPERATOR** terminal block. The green wire should be inserted into the **GRN** terminal, the blue wire into **BLU**, the orange wire into **ORG**, black wire into **BLK**, and the red wire into the **RED** terminal.

Tighten the set screws against the stripped end of the wires. A dab of petroleum jelly on each terminal will help prevent corrosion.

Step D-9:

Cut slot into driveway and lay PVC conduit in this slot. Pull the 25 foot power cable for the second operator through the conduit (*see Illustration B on page 37*).



Step D-10:

Carefully insert the power cable plug into the coupling at the bottom of the operator housing. Turn the plug until it aligns with the pins in the operator coupling. Tighten the sleeve nut to lock the plug into place.

NOTE: DO NOT attempt to splice the power cable, and DO NOT remove the connector from the end of the cable. If you need a longer cable, 35 foot and 40 foot power cables are available (*see Accessory Catalog*).

Setting the Control Board for Dual Gate Installations

DIP Switches

The Control Board DIP switches must be set to accommodate your particular type of installation. Since the **SNGL/DUAL**, **SEQ1**, and **SEQ2** DIP switches are used by dual gate operator systems, they will be discussed in the following steps.

Step D-11:

Make sure the control box power switch is **OFF**.

Step D-12:

Unscrew and remove the control box cover. Use a small screwdriver to move the **SNGL/DUAL** DIP switch to **DUAL** (*see illustration*).

The order of gate operation ("sequencing") must now be determined for your dual gate operators to function properly.

Refer to the illustrations on the next page.

NOTE: The terms "FIRST OPERATOR" and "SECOND OPERATOR" refer to a unit wired to the terminal block of the same name.

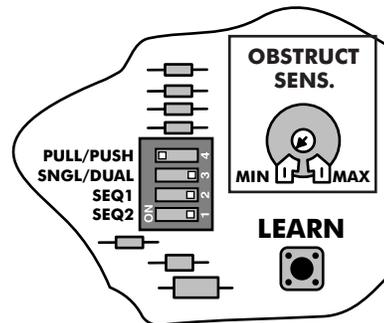

Step D-13

BOTH OPERATORS **OPEN** SIMULTANEOUSLY
BOTH OPERATORS **CLOSE** SIMULTANEOUSLY

SEQ1 = ON SEQ2 = OFF

If **SEQ1** is set to **ON**, and **SEQ2** is set to **OFF**, the **FIRST OPERATOR** and **SECOND OPERATOR** **open and close** simultaneously.

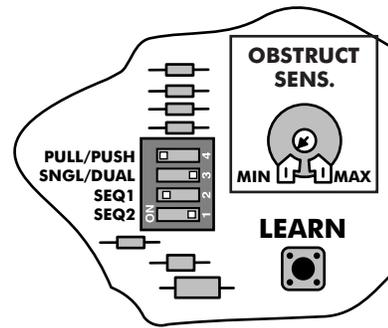

FIRST OPERATOR **OPENS** FIRST,
SECOND OPERATOR **CLOSES** FIRST

SEQ1 = OFF SEQ2 = ON

If **SEQ1** is set to **OFF**, and **SEQ2** is set to **ON**, the **FIRST OPERATOR** will **open** first, and the **SECOND OPERATOR** will **close** first (*see illustration*).

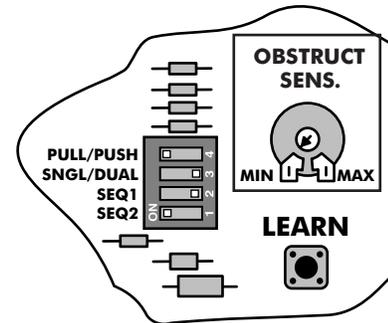

FIRST OPERATOR **OPENS** FIRST,
FIRST OPERATOR **CLOSES** FIRST

SEQ1 = ON SEQ2 = ON

If **SEQ1** is set to **ON**, and **SEQ2** is set to **ON**, The **FIRST OPERATOR** **opens** and **closes** first.

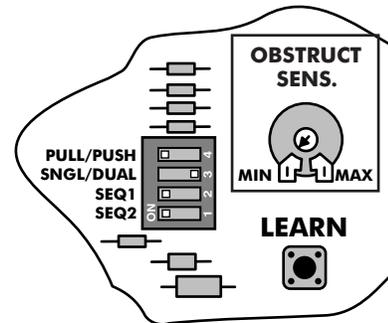

BOTH OPERATORS **OPEN** SIMULTANEOUSLY
SECOND OPERATOR **CLOSES** FIRST

SEQ1 = OFF SEQ2 = OFF

If both **SEQ1** and **SEQ2** are set to **OFF**, the **FIRST OPERATOR** and **SECOND OPERATOR** **open** simultaneously. The **SECOND OPERATOR** will **close** first.

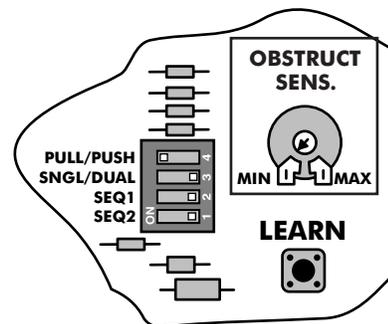

STEP D-14

Replace the control box cover. Turn the control box power switch **ON** and allow the control board 15 seconds to energize. Set the closed gate positions for the first and second operators (*review step 18 on page 19*).

Your automatic gate operator system is configured for dual pull-to-open gates.

GTO/PRO[®]
AUTOMATIC GATE OPERATORS

Accessories from GTO, Inc.

Available through your dealer.

Accessories Available Through Your Dealer

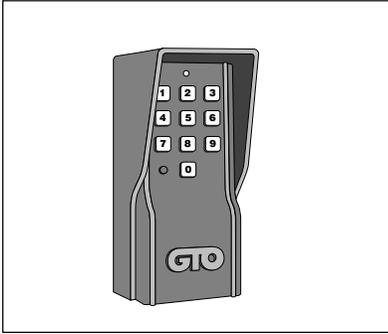

GTO Digital Keypad (F300)

The weatherproof digital keypad can be easily installed as a wired or wireless keypad for all GTO swing and slide gate operators, and as a wired keypad for the Bulldog Pedestrian Gate Lock. It can be programmed to recognize fifteen different personal identification number (PIN) codes. Each code is face programmable with additional security features built in. Requires 3 AA batteries (*not included*). Can also accommodate most garage doors and other gate openers. If used as a wired keypad, 16 gauge standard, low voltage direct burial wire will be required (*see RB509*).

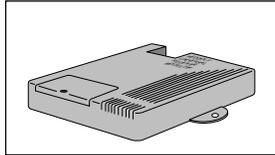

Garage Door Receiver (RB709)

Allows the use of the same GTO remote transmitter (*see Dual and Triple Transmitters*) to control the gate operator and garage door opener. Compatible with most garage door openers.

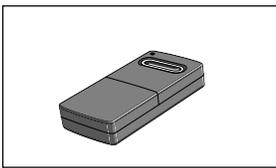

GTO Entry Transmitter (RB741)

The GTO Entry Transmitter, with adjustable code settings, is standard equipment with all GTO gate operator systems. Battery included.

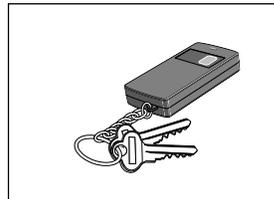

GTO Key Chain Mini Transmitter (RB744)

This miniature version of the GTO entry transmitter has the same adjustable code settings. Battery included.

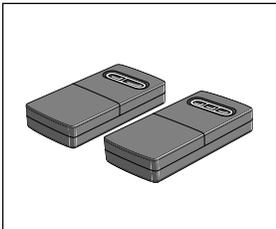

GTO Dual Transmitter (RB742) GTO Triple Transmitter (RB743)

The two and three button transmitters are used for the remote control of two or three gate operators and garage door openers (*See Garage Door Receiver*). Battery included.

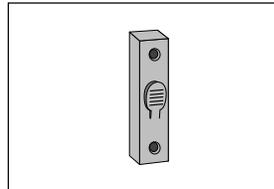

Push Button (Doorbell) Control (RB101)

Unlighted doorbell button for remote entry or exit control. Connects directly to the control board using 16 gauge stranded, low voltage, direct burial wire (*not included, see RB 509*).

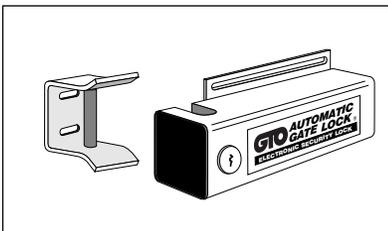

GTO Automatic Gate Lock (FM144) for closed position pull-to-open applications

A MUST for added security. The plated steel bolt lock has a zinc plated steel housing and is driven by a 4 ampere solenoid. This horizontal electronic lock is used with all GTO low voltage swing gate operator systems (not to be used with GTO/PRO AC powered operators) for additional security and stability. Comes with a keyed manual release.

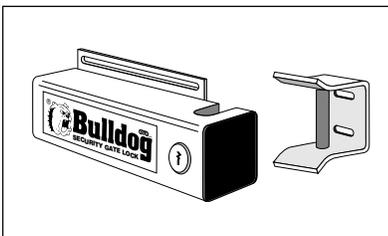

GTO Automatic Gate Lock (FM142) for open position or push-to-open applications

Similar to FM144, but used to secure gates in the open position or for push-to-open gate applications (*not shown*).

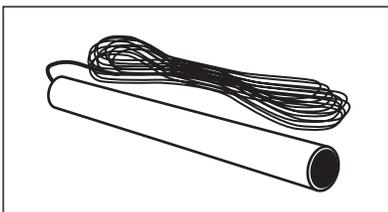

GTO Bulldog Pedestrian Gate Lock (FM500)

Similar to the Automatic Gate Lock but designed for horizontal use only on "walk-through" gates without automatic operators. The Bulldog is an affordable solution to protecting swimming pool areas, playgrounds, tennis courts, boat docks, etc., from unwanted access. Includes control box and keyed manual release. Can be used with the GTO Digital Keypad (F300).

GTO Exit Wand (FM138)

The GTO Exit Wand is designed for residential and agricultural applications and is compatible with all the GTO/PRO automatic gate opener models. The Exit Wand is an electromagnetic sensor, which offers 'hands free' operation of automatic gate openers with a 12 ft. radius of detection of vehicles in motion.

ACCESS-ories

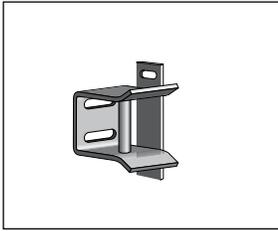

Column Mount Lock Receiver (433IH)

For mounting the **Automatic Gate Lock** or **Bulldog Pedestrian Lock** in areas with limited space between the gate and post, such as brick columns or walls.

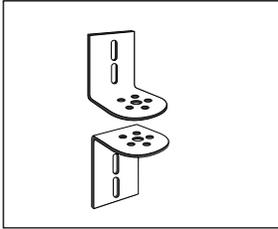

Column Mount Bracket (349IH)

For column installation of the GTO/PRO 1000 series operators. Designed for mounting the Post Pivot Bracket on masonry columns or any flat surface. **Two Brackets are required for each operator.**

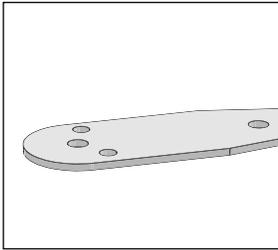

Push To Open Bracket (348IH)

Required when **GTO/PRO 1000** series gate operator(s) must push the gate open, such as on a sloping driveway or where space prevents gate(s) from opening inward (pulled open). **Order two PTO brackets for conversion of a dual swing gate installation.**

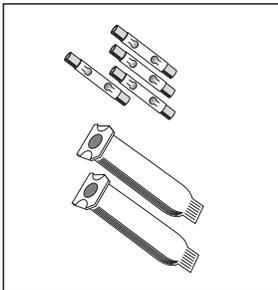

Splice Kit - Above Ground (RB707)

For providing secure and moisture resistant above ground splices for solar panels, key pads, push buttons and other accessories using GTO low voltage wire.

Splice Kit - Direct Burial (RB708)

When direct burial wire running below ground needs to be spliced the **RB708** splice kit **must** be used.

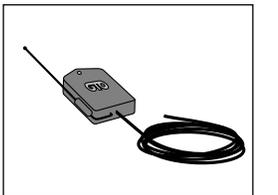

Replacement Receivers

The **AQ201**: Receiver with a 10 ft. cable (included).

The **AWQ325**: Receiver with a 25 ft. cable.

The **AWQ350**: Receiver with a 50 ft. cable.

The **AWQ400**: Receiver with a 100 ft. cable.

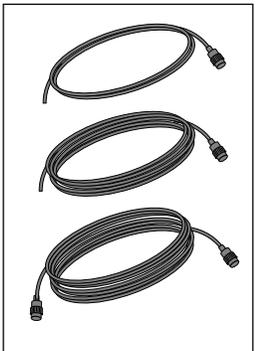

Standard Replacement Power Cables for Gate Operators

The **PRO 4.5C (AW201)**: 4.5 ft. power cable included with **GTO/PRO 1000** gate operators *with* serial numbers.

The **PRO 25C (AW202)**: 25 ft. power cable included with **GTO/PRO 1000/1200** gate operators *with* serial numbers.

The **PRO 40C (AC109)**: 40 ft. power cable for **GTO/PRO 1000** series operators.

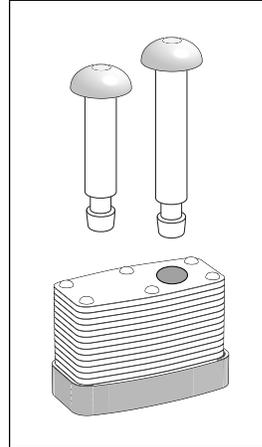

Master® Pin Lock (RB975)

for GTO/PRO 1000/1200

Master® Pin Lock (FM320)

for GTO/PRO 2000/2200

The pin lock is a substitute for the clevis pin at either or both mounting points of the GTO/PRO 1000 operator arms and the gate bracket end of the GTO/PRO 2000. They help prevent theft of the operator arm while allowing quick release of the operator when necessary.

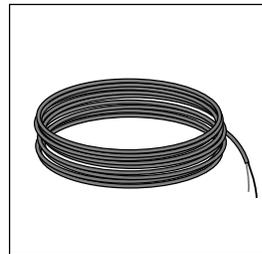

GTO Low Voltage Wire (RB509)

The 16 gauge dual conductor, multi-stranded, direct burial low voltage wire is required to connect the control board to the solar panel or the AC transformer. This wire is also required for installation of some accessories such as keypads, locks, or push buttons (*available in 1000' rolls and specially cut lengths*).

ACCESS -ories

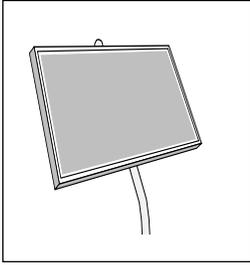

Operator Solar Panel (FM123) - Improved, Amorphous Silicon

This 10 watt solar panel is a battery charger for use with **GTO/PRO Low Voltage Automatic Gate Operator** systems. Particularly suited for remote installations, the solar panel comes with tubular steel support, mounting clips, wire connectors, and 8 ft. of low voltage wire (*for longer lengths, see RB509*). All GTO low voltage operators are pre-wired for solar panels. Installation in some regions of the world will require multiple panels for adequate charging power. Recommended for **GTO/PRO 2000/2200, GTO/PRO SL-1000/SL-1200**.

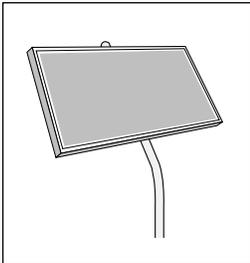

Operator Solar Panel (FM122) - Improved Amorphous Silicon

The 5 watt solar panel is a battery charger for use with **GTO/PRO Low Voltage Automatic Gate Operator** systems. Particularly suited for remote installations, the solar panel comes with tubular steel support, mounting clips, wire connectors, and 8 ft. of low voltage wire (*see Low Voltage Wire for longer wire*). All GTO low voltage operators are pre-wired for solar panels. Installation in some regions of the world will require multiple panels for adequate charging power. Recommended for **GTO/PRO 1000, GTO/PRO 1200** and the **GTO Bulldog Gate Lock**.

Dual gate installations require minimum of two (2) 5 watt solar panels for adequate charging power.

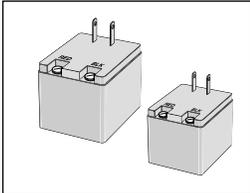

Transformers for charging the gate operator battery

RB566 – Standard 18 volt, 20 VA, AC transformer for **GTO/PRO 1000 series** gate operators *with* serial numbers.

Bulldog Replacement Charger

RB421 – Standard 12 volt DC charger (*not shown*) for maintaining battery included with the Bulldog Pedestrian Gate Lock.

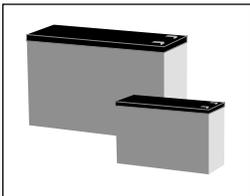

Replacement Batteries

RB500 – The standard 12 volt, 7.0 ampere-hour, maintenance-free battery for all **GTO/PRO** gate operators. This is the only battery approved for use with **GTO** gate operators. Battery life 3 to 5 years.

RB422 –The 12 volt, 1.2 ampere-hour version for use with the Bulldog Pedestrian Gate Lock.

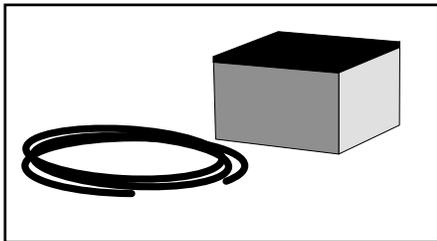

26 Amp Hour Battery Kit (FB296)

This large 12 volt, 26 ampere-hour, maintenance-free battery is for the **GTO/PRO** gate operators. It will supply additional power for increasing the number of open and close cycles. The kit comes with the battery and wiring harness for easy installation. Battery life 3 to 5 years.

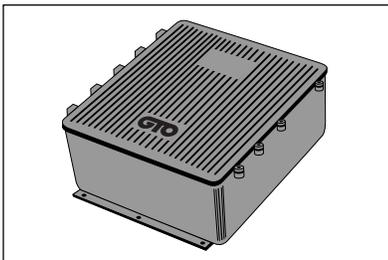

GTO NEMA Box (FM317)

GTO's NEMA 4X rated weatherproof box is large enough (14" W x 6" D x 16" H) to accommodate all add-on items necessary for custom gate operator installations. It is made of fire retardant ABS plastic and comes with a heavy duty 14 gauge steel backing plate for mounting accessories. The unique, lockable cover (use the Master® Pin lock RB975 for added security) can be completely removed for easier access during installation and service.

The NEMA box is standard on all **GTO/PRO AC** powered operators.

GTO, Inc. gate operator accessories are warranted by the manufacturer against defects in materials and workmanship for a period of one year, unless otherwise stated, from the date of purchase provided recommended installation procedures have been followed. Warranty is considered void if damage was due to improper installation or use, connection to an improper power source, or was caused by lightning, wind, fire, flood, insects, or other natural agent.

Installation Check List

The installation of this operator conforms to CLASS _____.

The installer verifies that (each item except *safety edges* must be checked):

- Recommended safety edges were installed.
- Customer was informed that this gate is for vehicular use **ONLY**. Pedestrians **MAY NOT** use this gate.
- A separate gate or entrance was installed for pedestrian use.
- Closed position stop plate was securely fastened.
- The position of the post bracket assembly complies with the 4 1/2" x 4 1/2" setback requirement.
- All power cables, receiver cables, and transformer plugs were securely fastened.
- Petroleum jelly was applied to the control board terminals.
- All warning signs and labels were installed as specified in the **IMPORTANT SAFETY INSTRUCTIONS**.
- Safety instructions were reviewed with the customer.
- A copy of the **IMPORTANT SAFETY INSTRUCTIONS** was given to the customer.
- Customer was instructed about disconnecting the operator for manual operation of the gate.
- Customer was instructed about proper use of transmitter and (or) other entry controls.
- Customer was asked to fill out customer support card and mail it to GTO, Inc.
- Customer was asked to retain **all receipts** (receipts provide proof of warranty).
- Customer was asked to retain **IMPORTANT SAFETY INSTRUCTIONS**, etc. for future reference.
- The completed installation was photographed from both the front and back of the gate. Photo was dated.

Customer's Signature

Date

Installer's Signature

Date