

Instruction Manual for the



E-S 1600 / E-S 1602 Series



Installation Video



FREE Available
Install Video **24/7**

View it on
www.EstateSwing.com

!Warning!

Read all instructions before beginning installation or use of this gate opener.

This operator exerts a high level of force.

Exercise caution at all times and stay clear of the system during operation.

Manufactured by

FAAC
An ISO 9001 Certified Company USA

CE DECLARATION OF CONFORMITY OF MACHINES

(Directive 89/392/EEC, Annex II, Part B)

Manufacturer: FAAC S.p.A.

Address: Via Benini, 1 – 40069 Zola Predosa Bologna – Italy

Declares that: 409 A.K.A. Estate Swing (USA) mod operator

- Is built to be integrated into a machine or to be assembled with other machinery to create a machine under the provisions of Directive 89/392/EEC, and subsequent amendments 91/368/EEC, 93/44/EEC.
- Conforms to the essential safety requirements of the following EEC directives:
 - 73/23/EEC and subsequent amendment 93/68/EEC, 89/336/EEC and subsequent amendment 92/31/EEC and 93/68/EEC.
 - And also declares the it is prohibited to put into service the machinery until the machine in which it will be integrated or of which it will become a component has been identified and declared as conforming to the conditions of Directive 89/392/EEC and subsequent amendments assimilated under national laws under DPR #459 of July 24, 1996.

Bologna, January 1, 2002

Managing Director

A. Bassi



Warnings for the installer General safety obligations

1. Attention! To ensure the safety of people, it is important that you read all the following instructions. Incorrect installation or incorrect use of the product could cause serious harm to people.
2. Carefully read the instructions before beginning to install the product.
3. Store these instructions for future reference.
4. This product was designed and built strictly for the use indicated in the documentation. Any other use, not expressly indicated here, could compromise the good condition/operation of the product and/or be a source of danger.
5. FAAC declines all liability caused by improper use or use other than that for which automated system was intended.
6. Do not install the equipment in an explosive atmosphere; the presence of inflammable gas or fumes is a serious danger to safety.
7. The mechanical parts must conform to the provisions of Standards EN 12604 and EN 12605.

For non-EU countries, to obtain an adequate level of safety, the standards mentioned above must be observed, in addition to national legal regulations.

8. FAAC is not responsible for failure to observe Good Technique in the construction of the closing elements to be motorized, of for any deformation that may occur during use.
9. The installation must conform to Standards EN 12453 and EN 12445.

The safety level of the automated system must be C+D.

10. Before attempting any job on the system, cut out electrical power and disconnect the batteries.
11. The main power supply of the automated system must be fitted with an all-pole switch with contact opening distance of 3 mm or greater. Use of a 6A thermal breaker will all-pole circuit break is recommended.
12. Make sure that a differential switch with threshold of 0.03 A is fitted upstream of the system.
13. Make sure that the earthing system is perfectly constructed, and connect metal parts of the means of the closure to it.
14. The automated system is supplied with an intrinsic anti-crushing safety device consisting of a torque control. Nevertheless, its tripping threshold must be checked as specified in the Standards indicated at point 10.
15. The safety devices (EN 12978 standard) protect any danger areas against mechanical movement risks, such as crushing, dragging, and shearing.
16. Use of at least one indicator-light (e.g. FAACLIGHT 12VDC) is recommended for every system, as well as a warning sign adequately secured to the frame structure, in addition to the devices mentioned at point "15".
17. FAAC declines all liability as concerns safety and efficient operation of the automated system, is system components not produced by FAAC are used.
18. For maintenance, strictly use original parts by FAAC.
19. Do not in any way modify the components of the automated system.
20. The installer shall supply all information concerning manual operation of the system in case of an emergency, and shall hand over to the user the warnings handbook supplied with the product.
21. Do not allow children or adults to stay near the product while it is operating.
22. Keep remote controls or other pulse generators away from children, to prevent the automated system from being activated involuntarily.
23. Transit through the leaves is allowed only when the gate is fully open.
24. The user must not attempt any kind of repair or direct action whatever and contact qualified personnel only.
25. Do not short-circuit the poles of the batteries and do not try to recharge the batteries with power supply units other than Master or Slave cards.
26. Do not throw exhausted batteries into containers for other waste but dispose them in the appropriate containers to enable them to be recycled.
27. **Anything not expressly specified in these instructions is not permitted.**

Estate Swing Summary of Functions

The Estate Swing is only to be used for vehicular swing gates in a Class I setting.

Class I: A vehicular gate opener (or system) intended for use in a home of one-to-four single family dwelling, or a garage or parking area associated therewith.

The FAAC Estate Swing automated system was designed and built for controlling vehicle access. Do not use for any other purpose.

The external automation with an electro-mechanical non-reversing linear arm automates residential swing-leaf gates with leaves of up to 16' in length. It consists of an irreversible electro-mechanical operator with built in opening and closing limits and utilizes a worm screw system. The irreversible system ensures the gate is mechanical locked when the motor is not operating. A lock still needs to be installed if security or high winds are a concern. A manual release makes it possible to move the gate in the event of a power-cut or fault.

For Your Assistance

Keep this manual safely stored after installation.

Serial Number _____

Date of Purchase _____





Place of Purchase _____

Have this information on hand while handling all service and warranty issues.

The table of contents are listed to assist you locating a desired section. We do however strongly suggest studying every page of the instruction manual before attempting installation.

SECTION:

Table of Contents

• Review of specifications, warnings, and tools	1	
⇒ Specifications of the Estate Swing and Components	1.1	
⇒ Parts List	1.2	
⇒ System Overview & Preliminary Checks	1.3	
⇒ Tools Needed for Installation	1.4	
• Installation	2	
⇒ Manual Operation, Restoring Automation	2.1	
⇒ READ FIRST: Determining Push or Pull to Open	2.2	
⇒ IMPORTANT: Determining Setback— Pull to Open	2.3	
⇒ Installation of Operator— Pull to Open	2.4-.9	
⇒ IMPORTANT: Determining Setback— Push to Open	2.10	
⇒ Installation of Operator— Push to Open	2.11-.16	
⇒ <i>Positive Stops and E-S 1602 Dual Considerations</i>	2.17	
• Wiring, Jumpers and Receiver	3	
⇒ Mounting the Control Box	3.1	
⇒ Mounting Back-up Batteries—if applicable	3.2	
⇒ Removing Terminal Strips for Wiring	3.3	
⇒ Wiring Operator Arm(s) (Pull & Push to Open)	3.4-.6	
⇒ Temporary Safety Jumpers	3.7	
⇒ Power	3.8	
⇒ 433 Plug-in Receiver	3.9-.10	
• Programming the Operator	4	
⇒ Programming Operating Parameters	4.1	
⇒ Operating Parameters Chart	4.2-.3	
⇒ Programming Gate Movements	4.4-.5	

The table of contents are listed to assist you locating a desired section. We do however strongly suggest studying every page of the instruction manual before attempting installation.

Table of Contents

SECTION:

• Diagnostics and Troubleshooting	5	
⇒LED Lights and Operational Displays	5.1	
⇒Troubleshooting	5.2-4	
• Accessories	6	
⇒Control Board Overview	6.1-2	
⇒Photocell and Safety Device Guide	6.3	
⇒Accessories	6.4-5	



Marks pages with opener or usage warnings. Although we have marked these as very important warnings, **please read the entire manual**. Every step is important to the correct installation of your gate opener.

Specifications

MODEL	Estate Swing
Power Supply	115V AC/ 24V AC
Rated Absorbed Power (W)	70
Current (A)	3
Travel (in.)	11
Cycles per hour	Continuous Duty / Aprox. 75
Operating Ambient Temp	-4 to 131 F
Protection class	IP44
Gate leaf max length (ft.)	Up to 16
Gate leaf max weight (lbs.)	Up to 800
Operator overall dimensions LxHxD(in.)	See below
Operator Weight	18 lbs

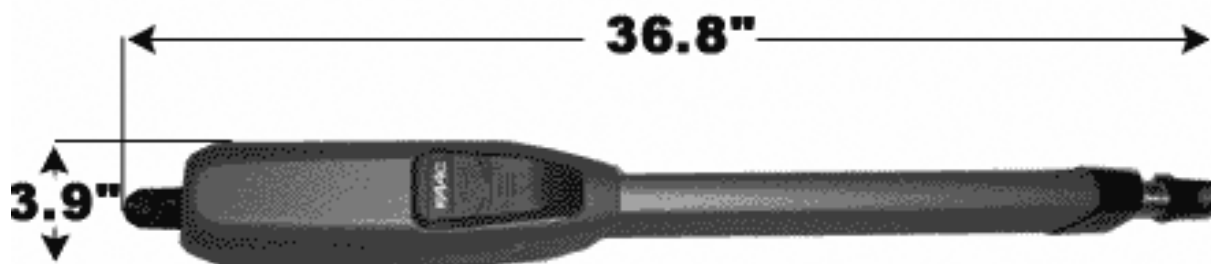
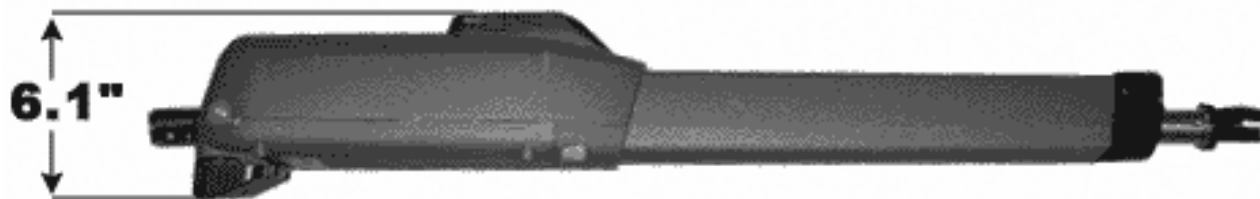

Estate Swing Parts List

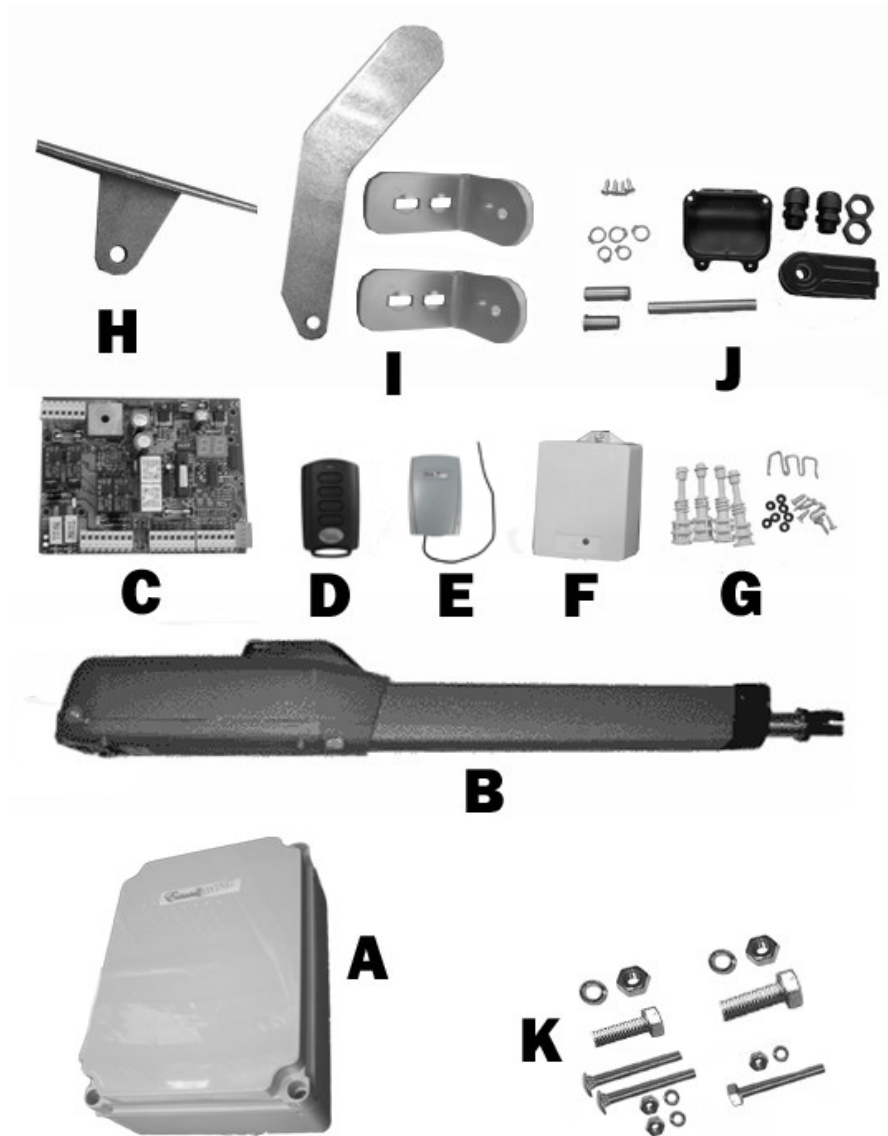

Master or Single Operator

- A. Control Box
- B. Operator Arm with 7' of 5 Conductor Wire and Key
- C. Control Board
- D. Transmitter
- E. Receiver
- F. Transformer
- G. Control Box Screws, Control Board Screws and Washers, Jumper Wire
- H. Gate Mounting Bracket
- I. Post Mounting Brackets
- J. Connector Pins and C Rings, Terminal Board Cover and Screws, Rear Fitting, Water Tight Connectors
- K. Mounting Hardware
1 - 3/8"x1 1/2" Hex bolts, washer, nut
1 - 5/16"x1 1/2" Hex bolt, washer, nut
2 - 3/8"x2" Carriage bolt, washers, nut
1 - 1/4"x2" Hex bolt, washers, nut

Slave Operator (If Applicable)

- B. Operator Arm with 45' of 5 Conductor Wire
- H. Gate Mounting Bracket
- I. Post Mounting Brackets
- J. Connector Pins and C Rings, Terminal Board Cover and Screws, Rear Fitting, Water Tight Connectors
- K. Mounting Hardware
1 - 3/8"x1 1/2" Hex bolts, washer, nut
1 - 5/16"x1 1/2" Hex bolt, washer, nut
2 - 3/8"x2" Carriage bolt, washers, nut
1 - 1/4"x2" Hex bolt, washers, nut

Standard System Overview and Safety Zones

The system display to the below is a recommended standard system. Other approved accessories can be installed. Photo sensors and a flashing light indicating gate movement is recommended for safety purposes.

- 1,2 Estate Swing Operator
- 3 Photocells (not included)
- 4 Control board
- 5 N/A
- 6 Push button opening device (not included)
- 7 Receiver extension (not included)
- 8 12Vdc flashing lamp (not included)
- 9 Positive stop
- 10 DC transformer



Notes:

- 1) When laying electrical cables, use appropriate rigid and/or flexible tube.
- 2) Do not run any wires in the same conduit as 110 AC power that may be in the area. This will cause unwanted interference.

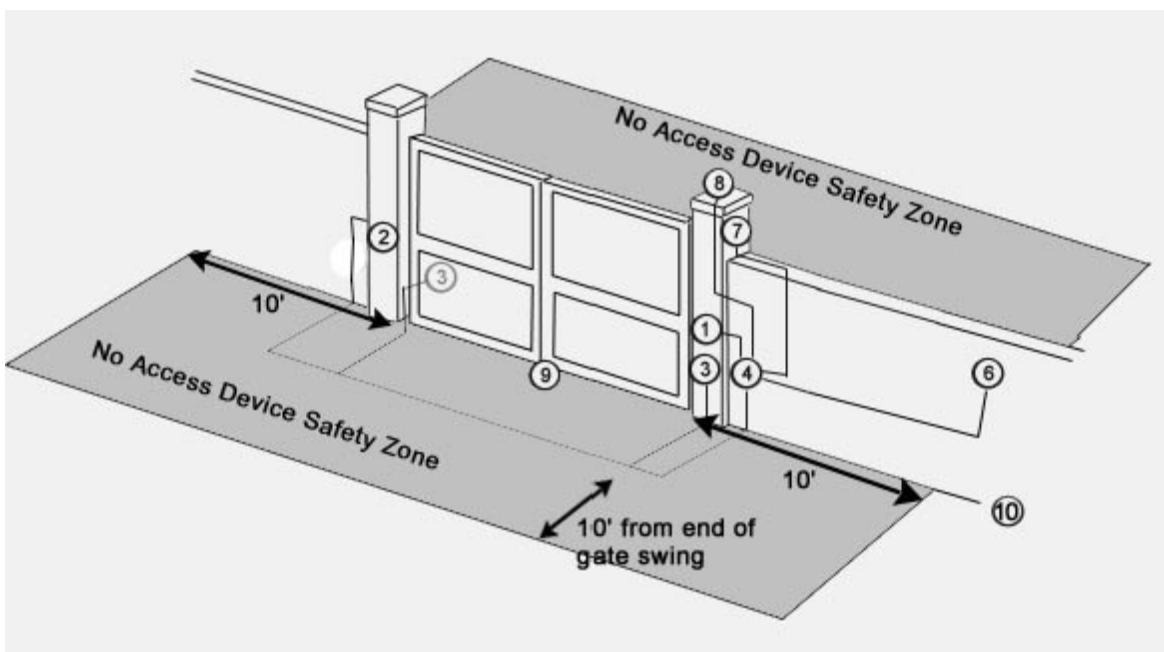

IMPORTANT Preliminary Checks:

To ensure safety and an efficiently operating automated system, make sure the following conditions are observed.

- The gate and post must be suitable for being automated. Check that the structure is sufficiently strong and rigid, and its dimensions and weights conform to those indicated on page 1.
- Make sure the leaves move smoothly without any irregular friction during entire travel.
- Make sure the hinges are in good condition. Ball bearing hinges are ideal for gates weighing over 200 lbs. or over 10' in length.
- Make sure the gate is plumb and level.
- The fence post must be secured in the ground with concrete. This will prevent alteration of alignments and leveling during installation and during cycles.

Tools Needed



- Power Drill
- Crescent Wrench
- Flat Head Screwdriver
- Hacksaw
- Phillips Head Screwdriver
- C-Ring Pliers
- Tape Measure
- Level
- Wire Strippers
- C-clamps
- 3/8", 1/4", 5/16" Drill Bits

Diagnostics

Other items that may be needed prior to commencing installation. ***Bolded items are necessary to all applications.***

- Start and stop post, bracket or door stop. Although the FAAC Estate swing 1600 features built in limit switches some may choose to use positive stops:
- **16, 14 or 12 gauge, 2 conductor stranded direct burial low voltage wire will be required to run power to your operator.** Length is determined by distance between transformer power supply and the control box.
- **4 - 3/8" Carriage Bolts will be needed to connect the 2 "L" shaped brackets to the post.** Length will be determined by the size of your posts.
- A metal support bracket may be needed to achieve the appropriate desired setback. The metal support bracket will be bolted or welded to your post to give a larger amount of space to mount the provided mounting bracket.
- A voltage meter and digital camera may be necessary to run diagnostic checks.
- If your transformer is going to be plugged into an outdoor outlet you will need to weatherproof that outlet and transformer. **Electrical boxes or plug covers** can be obtained from a local hardware store to accommodate both the plug and transformer.
- Hardware to attach the control box to a post or fence.
- Watertight connectors for running wires into the control box.
- Protect all ingoing and outgoing wires with a surge suppressor. Consult your local dealer for more information.

Manual Operation Mode

- 1) Slide lock cover forward.
- 2) Insert and turn provided key.
- 3) Flip release lever up.
- 4) Turn release lever 180 degrees to face the opposite direction. The operator shaft can now be manually pushed or pulled in and out.

To exit manual mode, reverse the above steps.

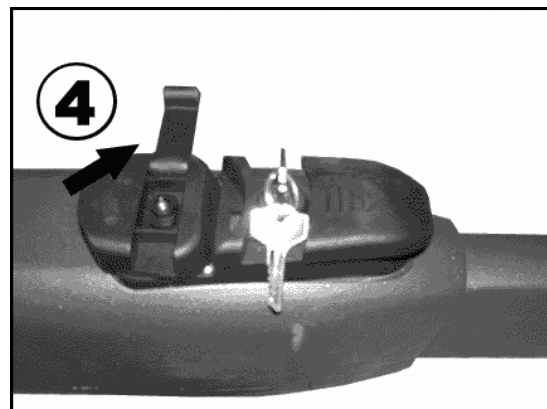
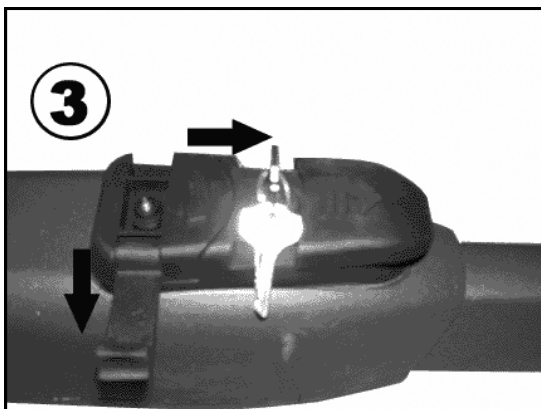
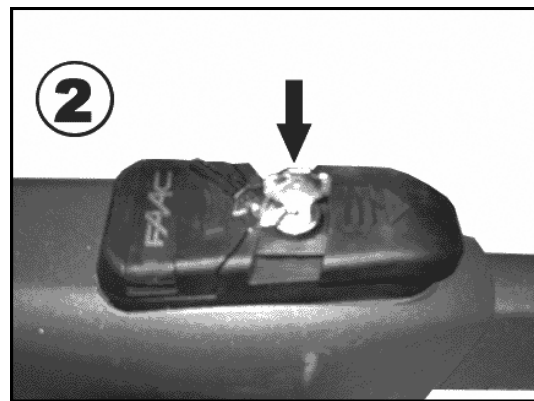
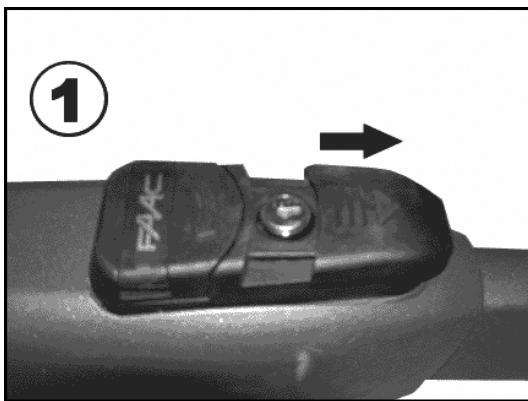

The following section is instructions on mounting your gate opener. Your gate can be mounted one of two ways:

Pull-To-Open: With the gate opener on the inside of the property, the gate will swing in towards the property. The gate opener will be extended in the gate's closed position and as the opener retracts it *PULLS* the gate open.

Instructions are pages 2.3 - 2.9

Push-To-Open: With the gate opener on the inside of the property, the gate will swing out away from the property towards the street. The gate opener will be retracted in the gate's closed position and as the opener extends it *PUSHES* the gate open.

Instructions are pages 2.10 - 2.16

After deciding which method you will use to automate your gate, make an X across the pages of the installation method you will not be using.

This will prevent mistakenly using the wrong instructions for your installation as the two sections look very similar.

IMPORTANT: Determining Correct Setback

PULL TO OPEN - Standard operation. This means the gate operator is mounted on the inside of the property and pulls your gate in towards the property.

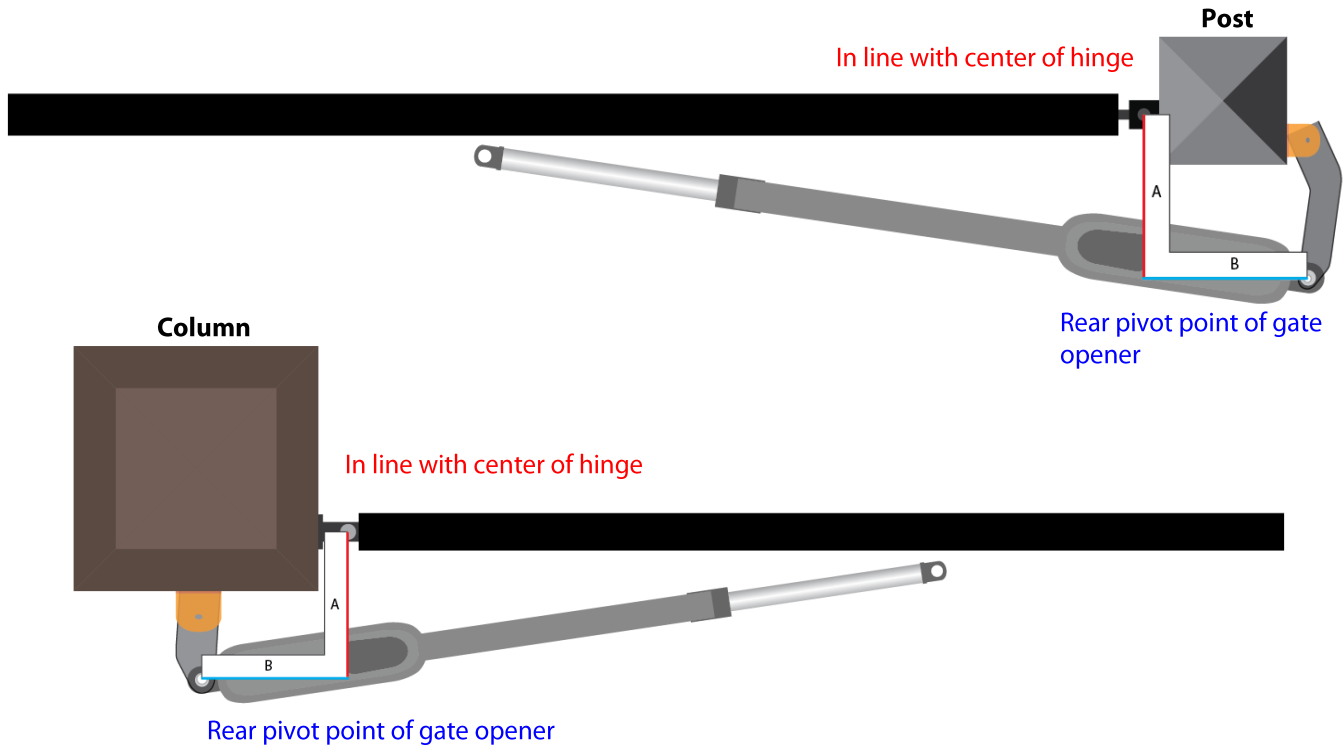

There are 4 factors to keep in mind when finding the setback mounting:

- 1) The (A) measurement is perpendicular from the gate in the CLOSED position.
- 2) There must be clearance for your gate opener to attach to the gate in the closed position. This is most commonly an issue on columns. Re-positioning of the hinges or Push-To-Open operation may be required to achieve clearance.
- 3) The brackets do not and must not move after installation.
- 4) The "L" shape brackets can be mounted anywhere on the post or column. They can be mounted on a separate post or fence as well. The only factor of importance is that when mounting of the brackets is done the hole in the boomerang bracket that the gate opener mounts on matches the setback on this page.

It is best to C-Clamp brackets on and test arm movement clearance before permanently attaching them.

A	B	α
7.5"	7.5"	90°
7"	7"	100°
6.5"	6.5"	110°

To determine the position of the gate mounting bracket (above is for the post mounting bracket) refer to step 9 in the section "Installation of operator"

Installation of Operator—Pull-to-Open

1. Find the proper set back for your operator (from previous page). Do this by holding the bottom “L” shaped bracket against the post. Marking its horizontal positioning on the post using a vertical line up from the middle of the bracket. Also mark your angled bracket for positioning on the “L” shaped bracket. The hole on the end of the angled bracket should be in the setback position.

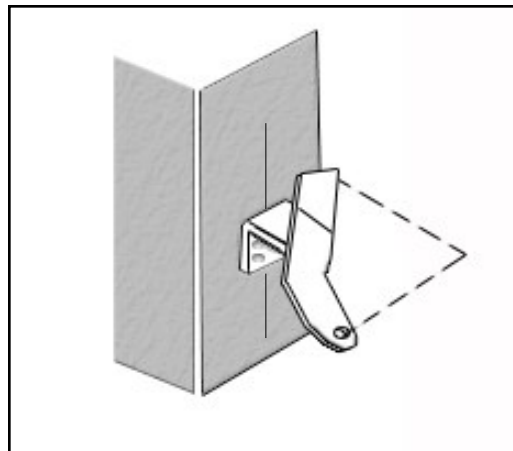

HINT: Trace the bracket on cardboard and use the cardboard to make a template.

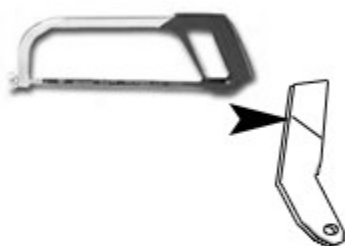

2. Cut off the excess length (if any) of the angled bracket using a hacksaw.



3. Position the angled bracket between the two “L” shaped brackets in the same position as when the setback was found. Clamp the 3 brackets together. Drill through the angled bracket using the pre-drilled holes in the “L” shaped brackets using a $3/8$ ” drill bit. Drill through all three brackets using a $5/16$ ” drill bit in a position behind the first hole.



4. Insert a $3/8$ ” x 1” bolt in the center hole and a $5/16$ ” bolt in the rear hole. Secure them using the provided nuts and lock washers.

Before permanently attaching any brackets, be sure to test arm motion and clearance.

5. **Temporarily** position the gate side mounting bracket. (*horizontal position does not matter, vertical position on the gate is the position you are matching to the post bracket.*) Position your assembled gate mounting along the previously drawn vertical line and level the angled piece with the horizontal piece of the gate mounting bracket using a level. Mark your holes, drill and attach the brackets using 4) 3/8" carriage bolts.

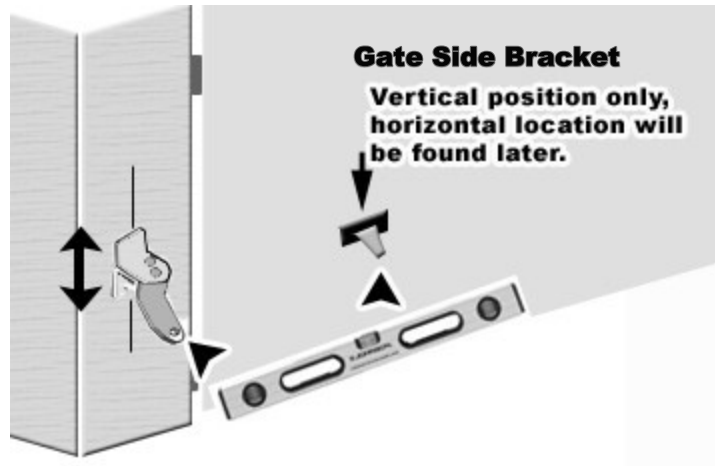

6. Assemble the rear fitting to the operator as shown below.

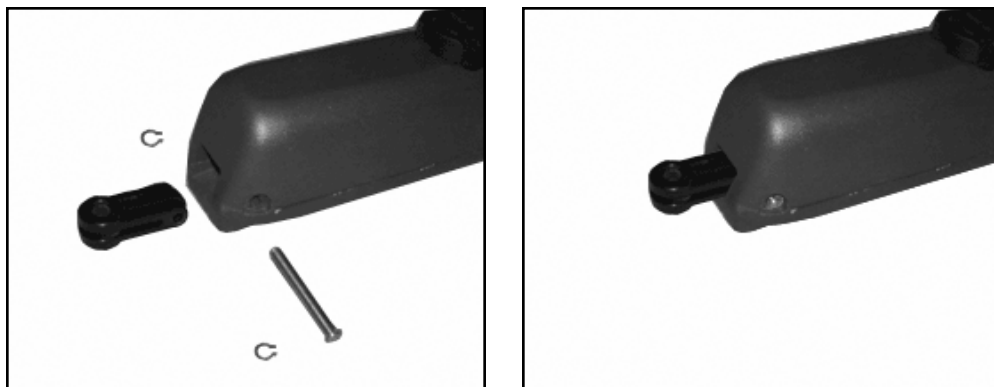

7. Run the 5 wires from the arm(s) to the control board as seen in section 3.

8. Set the operator for manual operation. And extend the operator arm to a near full extended position.

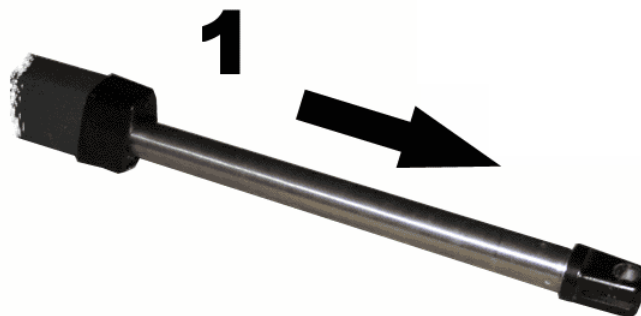

9. Extend the operator arm so the measurement between the center of the pivot hole on the rear bracket and the center of the pivot hole in the front mounting measures 50 3/4 inches. After finding the measurement relock your operator arm.

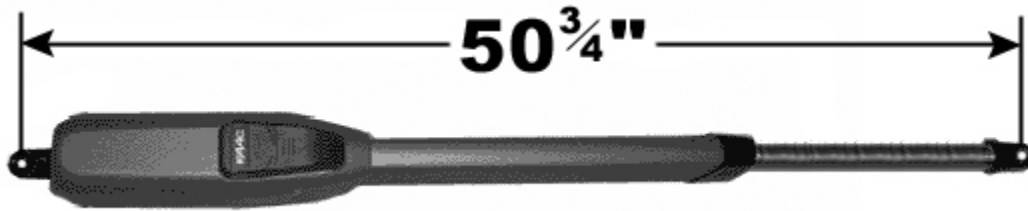

This is your closed mounting position.

10. Assemble the front gate mounting bracket as shown below. (bottom ring can be left off if security is not a concern)

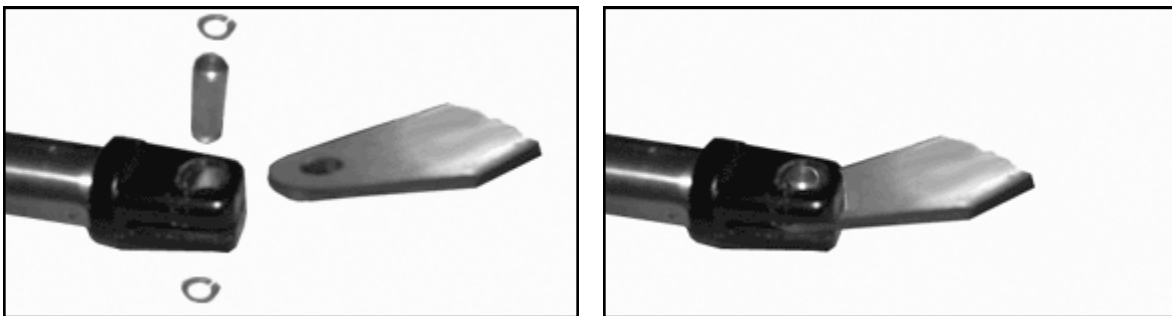

11. Attach the operator to the post mounting bracket using the supplied pins as shown below, support the arm to prevent dropping and breakage of the rear fitting. (bottom ring can be left off if security is not a concern)

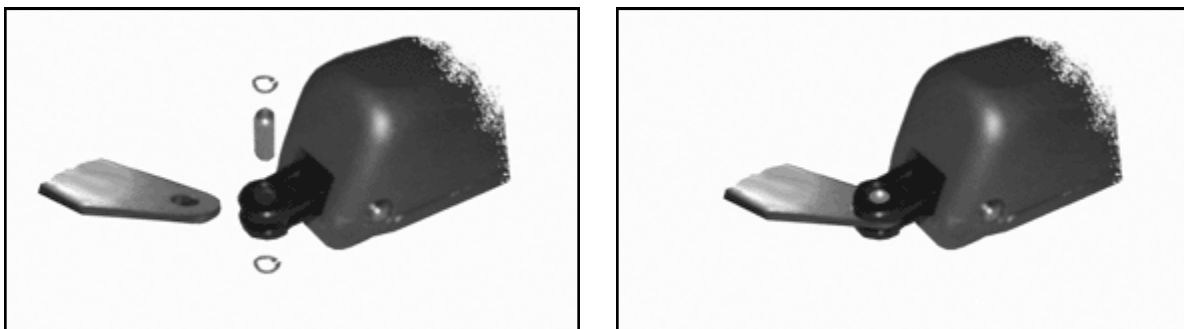

12. Close the gate leaf. With the operator attached on the post side, move the end of the arm to the gate and, keeping the gate operator in a perfectly horizontal position, determine the gate mounting position. *The arm should already be in it's full closed length that was determined in step 9.*

13. Attach the gate mounting bracket using carriage bolts, nuts, and washers.

14. Release the gate operator once more.

Manually test the gate by completely opening and closing it, checking for hindrances.

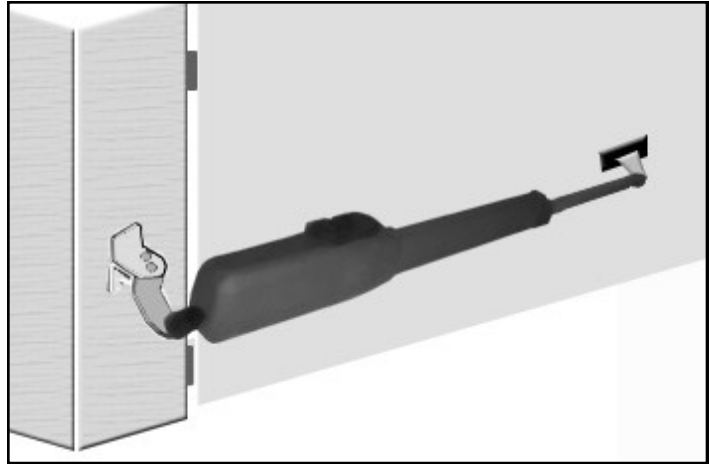

Gate in Closed position

Fine Tuning Limit Switches - Pull-to-Open

Understanding the limit switches

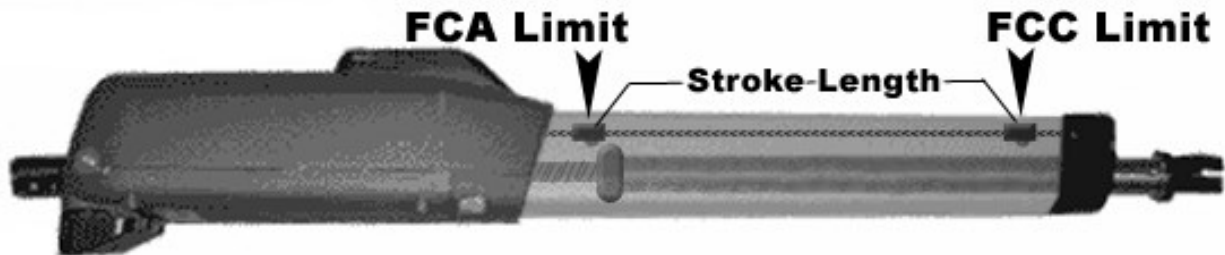

The stroke length is the distance between both limit switches. Increasing the stroke length will make your operator open further or close further.

Decreasing the stroke length will make your operator open less or close less.

The limit switches are for fine adjustment only and each turn of the limit adjustment screws only moves the switch slightly.

Never adjust a limit switch past resistance, this will damage the limit switch internally.

Continue to the next page for limit adjustment directions.

Fine Tuning Limit Switches - Pull-to-Open

Open Position Adjustment

- Move the gate slowly to the Open position (fig 1) until the **FCA1** light goes **OFF** (fig 2).
(FCA2 if working on the slave leaf of dual opener)
- To **increase** the stroke length turn the **FCA** screw: **COUNTER-CLOCKWISE** (fig 3).
(make the gate open more)
- To **decrease** the stroke length turn the **FCA** screw: **CLOCKWISE** (fig 3).
(make the gate open less)

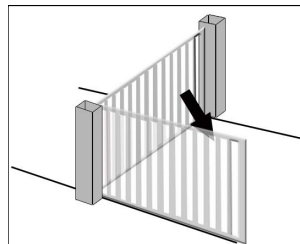

(fig 1)

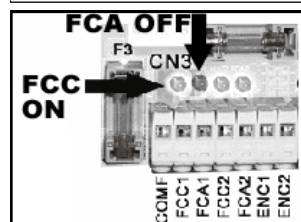

(fig 2)



(fig 3)

Closed Position Adjustment

- Move the gate slowly to the Closed position (fig 1) until the **FCC1** light goes **OFF** (fig 2).
(FCC2 if working on the slave leaf of dual opener)
- To **increase** the stroke length turn the **FCC** screw: **CLOCKWISE** (fig 3).
(make the gate close more)
- To **decrease** the stroke length turn the **FCC** screw: **COUNTER-CLOCKWISE** (fig 3).
(make the gate close less)

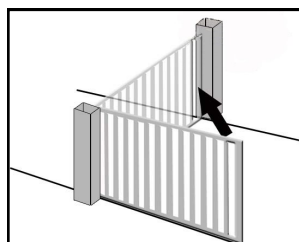

(fig 1)

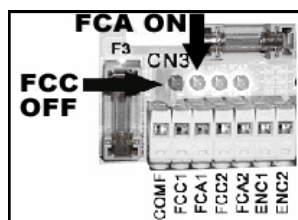

(fig 2)

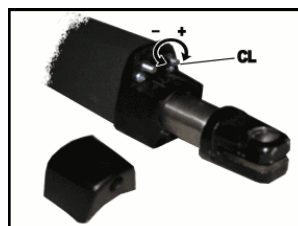

(fig 3)

IMPORTANT: Determining Correct Setback

PUSH TO OPEN - This operation is commonly used if you driveway slopes up after the gate, preventing it from swinging in. This means the gate opener is mounted on the inside of the property and pushes your gate out away from the property.

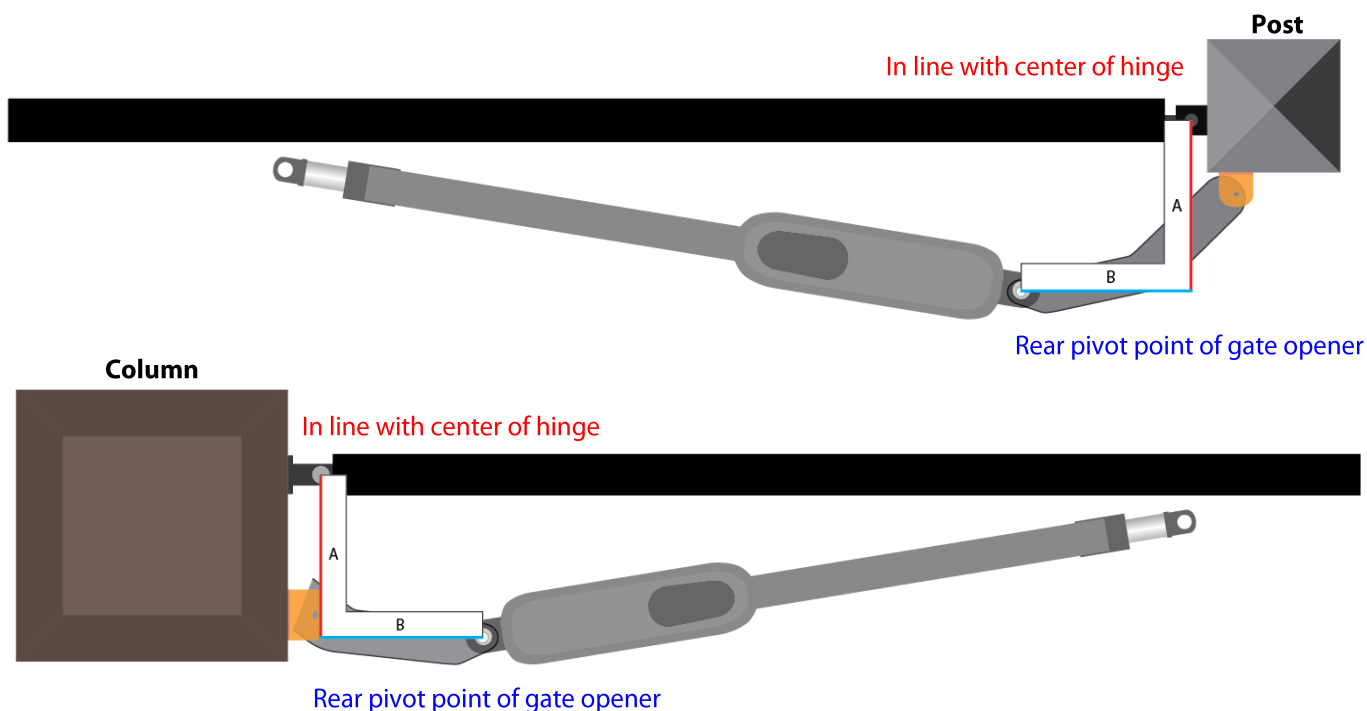

There are 4 factors to keep in mind when finding the setback mounting:

- 1) The (A) measurement is perpendicular from the gate in the CLOSED position.
- 2) There must be clearance for your gate opener to attach to the gate in the closed position. This is most commonly an issue on columns. Re-positioning of the hinges or Push-To-Open operation may be required to achieve clearance.
- 3) The brackets do not and must not move after installation.
- 4) The "L" shape brackets can be mounted anywhere on the post or column. They can be mounted on a separate post or fence as well. The only factor of importance is that when mounting of the brackets is done the hole in the boomerang bracket that the gate opener mounts on matches the setback on this page.

It is best to C-Clamp brackets on and test arm movement clearance before permanently attaching them.

To determine the position of the gate mounting bracket (above is for the post mounting bracket) refer to step 9 in the section "Installation of operator - PTO"

A	B	α
7.5"	7.5"	90°
7"	7"	100°
6.5"	6.5"	110°

Installation of Operator—Push-to-Open

1. Find the proper set back for your operator (from previous page). Do this by holding the bottom “L” shaped bracket against the post. Marking its horizontal positioning on the post using a vertical line up from the middle of the bracket. Also mark your angled bracket for positioning on the “L” shaped bracket. The hole on the end of the angled bracket should be in the setback position.

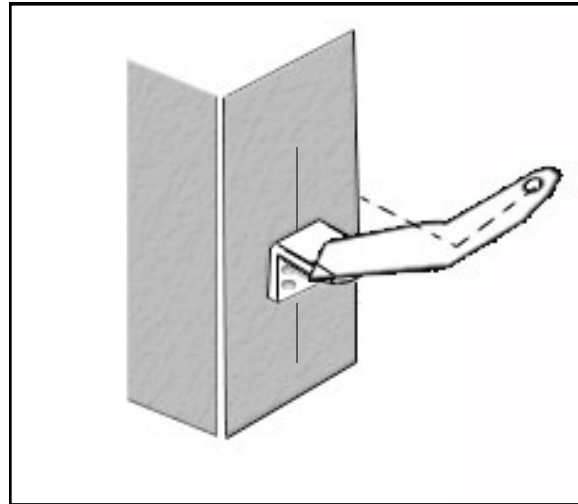

HINT: Trace the bracket on cardboard and use the cardboard to make a template.

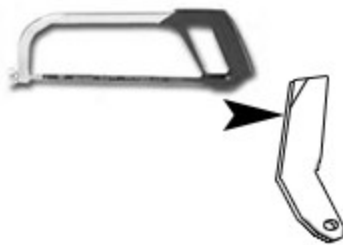

2. Cut off the excess length (if any) of the angled bracket using a hacksaw.



3. Position the angled bracket between the two “L” shaped brackets in the same position as when the setback was found. Clamp the 3 brackets together. Drill through the angled bracket using the pre-drilled holes in the “L” shaped brackets using a $3/8$ ” drill bit. Drill through all three brackets using a $5/16$ ” drill bit in a position behind the first hole.



4. Insert a $3/8$ ” x 1” bolt in the center hole and a $5/16$ ” bolt in the rear hole. Secure them using the provided nuts and lock washers.

Before permanently attaching any brackets, be sure to test arm motion and clearance.

5. Temporarily position the gate side mounting bracket. (*horizontal position does not matter, vertical position on the gate is the position you are matching to the post bracket.*) Position your assembled gate mounting along the previously drawn vertical line and level the angled piece with the horizontal piece of the gate mounting bracket using a level. Mark your holes, drill and attach the brackets using 4) 3/8" carriage bolts.

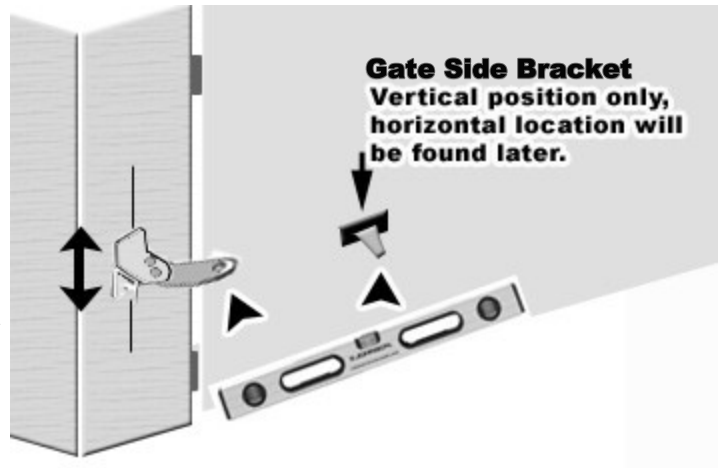

6. Assemble the rear fitting to the operator as shown below.

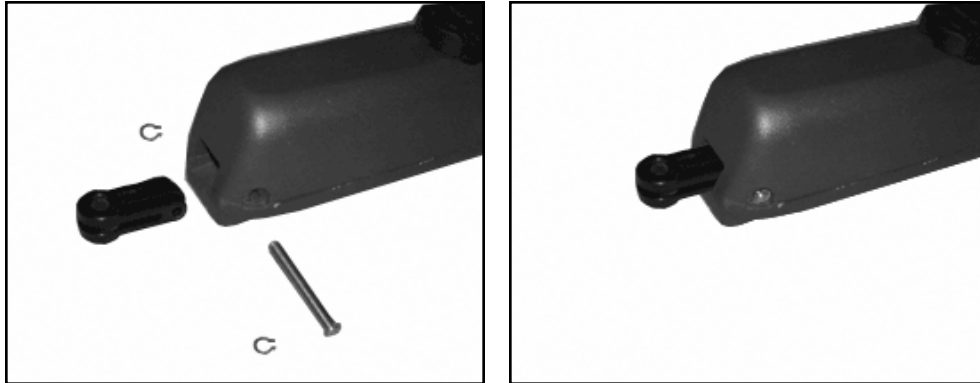

7. Run the 5 wires from the arm(s) to the control board as seen in section 3.

8. Set the operator for manual operation. And extend the operator arm slightly past the full retracted position..

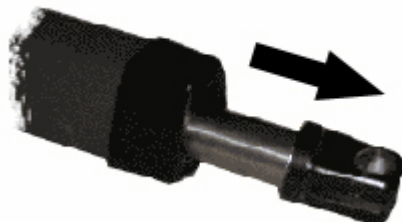

9. Extend the operator arm so the measurement between the center of the pivot hole on the rear bracket and the center of the pivot hole in the front mounting measures 37 inches. After finding the measurement relock your operator arm.



This is your closed mounting position.

10. Assemble the front gate mounting bracket as shown below. (bottom ring can be left off if security is not a concern)

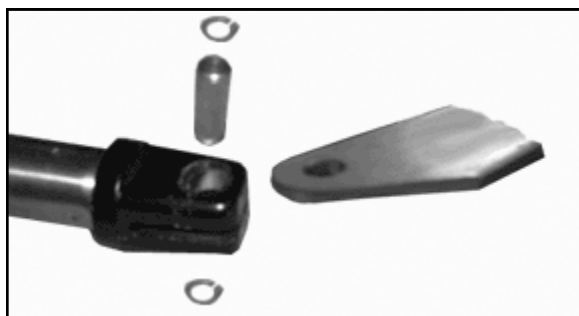

11. Attach the operator to the post mounting bracket using the supplied pins as shown below, support the arm to prevent dropping and breakage of the rear fitting. (bottom ring can be left off if security is not a concern)

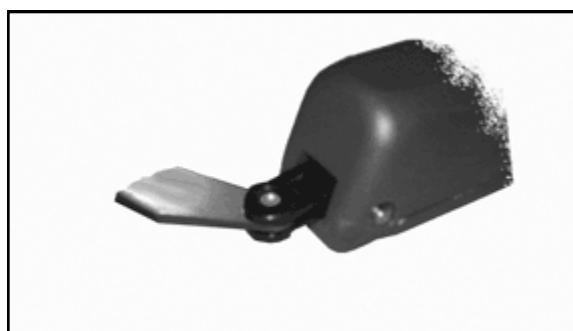

12. Close the gate leaf. With the operator attached on the post side, move the end of the arm to the gate and, keeping the gate operator in a perfectly horizontal position, determine the gate mounting position. *The arm should already be in it's full closed length that was determined in step 9.*

13. Attach the gate mounting bracket using carriage bolts, nuts, and washers.

14. Release the gate operator once more.

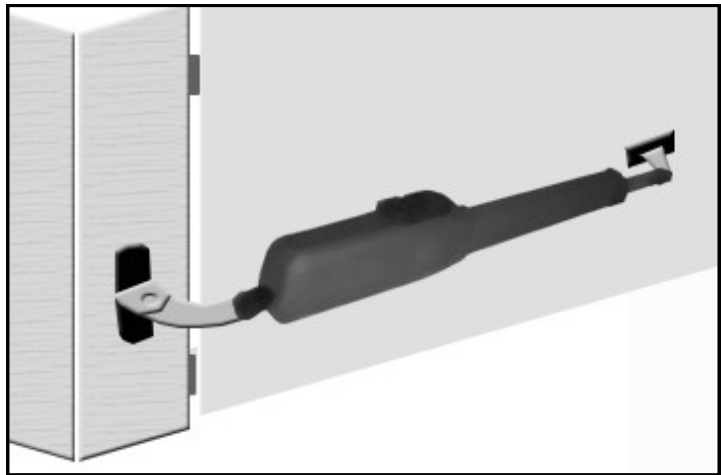

Gate in Closed position

Manually test the gate by completely opening and closing it, checking for hindrances.

Fine tuning Limit Switches - Push-to-Open

Understanding the limit switches

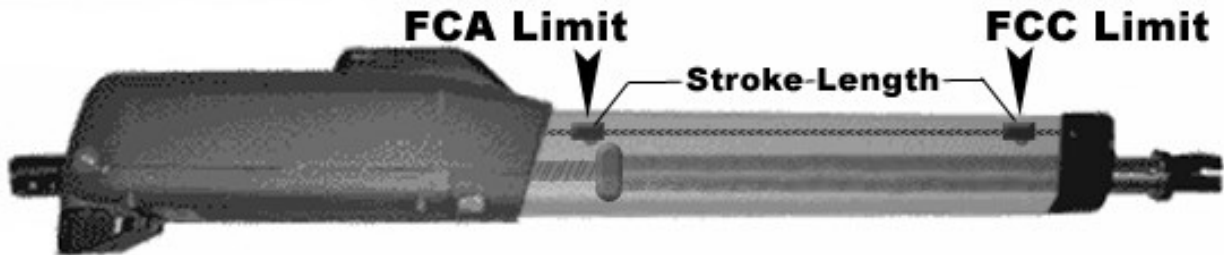

The stroke length is the distance between both limit switches. Increasing the stroke length will make your operator open further or close further.

Decreasing the stroke length will make your operator open less or close less.

The limit switches are for fine adjustment only and each turn of the limit adjustment screws only moves the switch slightly.

Never adjust a limit switch past resistance, this will damage the limit switch internally.

Continue to the next page for limit adjustment directions.

Fine Tuning Limit Switches - Push-to-Open

NOTE: On Push-To-Open FCA on the board matches up with FCC on the Arm and FCC on the board matches up with FCA on the Arm
Follow the printed directions for adjusting limits, this is not a typo.

Open Position Adjustment

- Move the gate slowly to the Open position (fig 1) until the **FCA1** light goes **OFF** (fig 2).
(FCA2 if working on the slave leaf of dual opener)
- To **increase** the stroke length turn the **FCC** screw: **CLOCKWISE** (fig 3).
(make the gate open more)
- To **decrease** the stroke length turn the **FCC** screw: **COUNTER-CLOCKWISE** (fig 3).
(make the gate open less)

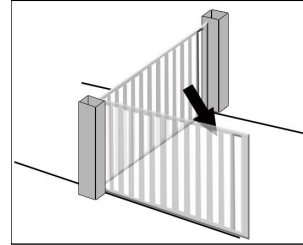

(fig 1)

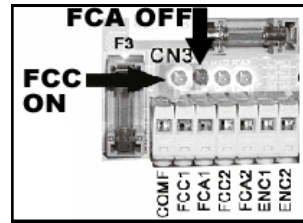

(fig 2)

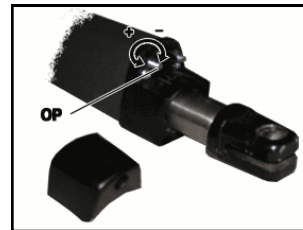

(fig 3)

Closed Position Adjustment

- Move the gate slowly to the Closed position (fig 1) until the **FCC1** light goes **OFF** (fig 2).
(FCC2 if working on the slave leaf of dual opener)
- To **increase** the stroke length turn the **FCA** screw: **COUNTER-CLOCKWISE** (fig 3).
(make the gate close more)
- To **decrease** the stroke length turn the **FCA** screw: **CLOCKWISE** (fig 3).
(make the gate close less)

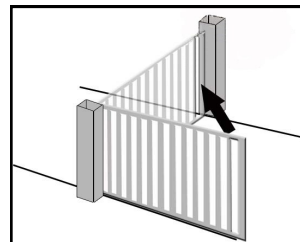

(fig 1)

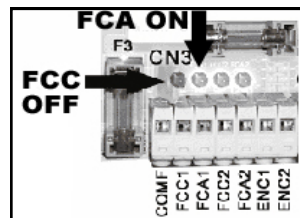

(fig 2)

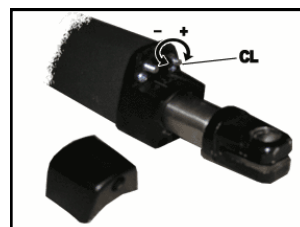

(fig 3)

If the light does not go out before a physical limitation is reached, decrease the stroke length.

Positive Stops and E-S 1602 Dual Considerations

Even though the E-S 1600/1602 arms come equipped with built in limit switches some people prefer to use positive stops instead.

Positive stops If positive stops are used alone you must be on operating parameter :



Positive stops are physical structures the gate comes in contact with at the end of the opening and closing cycles. The closed and open positive stop points can be a plate on the end of the gate that comes in contact with an adjacent post or an industrial door stop. (Many gates need an extension piece added to make contact with the door-

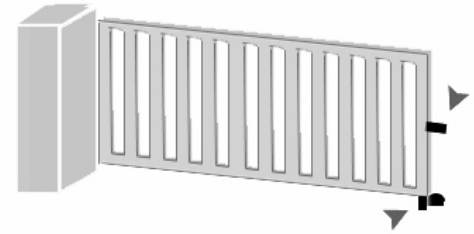

Examples of stops



Examples of industrial door stops

If not using the limit switches, and **ONLY** if NOT using the limit switches, you must jump between the limit switch terminals (FCC1, FCA1, FCC2, FCA2) and limit common (COMF).

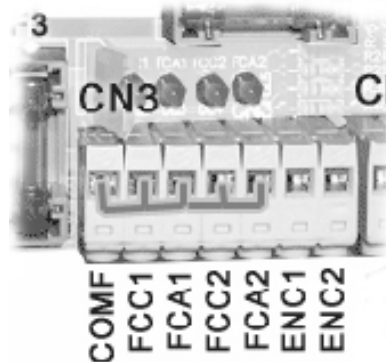

**ONLY IF NOT USING
LIMIT SWITCHES**

E-S 1602 considerations

The slave arm of the E-S 1602 installs the same way as the master arm in the previous installation steps. On the control board the terminals on terminal block CN2 and CN3 for the operator arms have a number at the end, either a 1 or 2.

- ⇒ Terminals ending with a 1 are master arm terminals.
- ⇒ Terminals ending with a 2 are slave arm terminals.

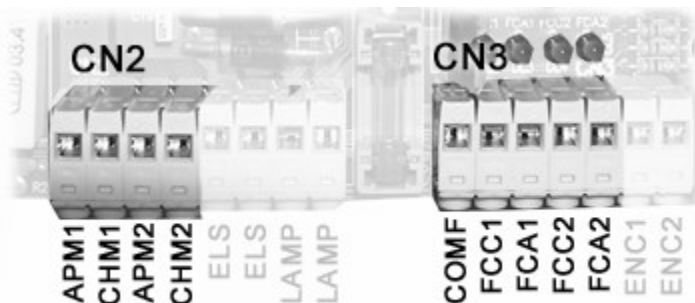

Mounting the Control Board and Box

Position your control box on the post of the gate or a nearby fence.

(1) Remove the rubber covers on the back of the box to reveal the holes. Use these holes to mount the box, and then put the rubber covers over the screw heads to prevent water leakage.

**For a dual operator set-up, the control box will be on the same side of the driveway as the master control arm.*

(2) Use the knockouts in the bottom of the box to run your wires into the control box. The knockouts are multi-sized - purchase water tight connectors to run the wires into the box. The water tight connectors go in the knockouts on the bottom.

(3) To mount the control board, first mount the control board stand in the center of the box.

(4) Place the caps provided over the pegs that will be used to attach the control board.

All wires being run to the control board should also be run through water-tight connectors. Connectors are available from most home stores or your Estate Swing dealer.

If using backup batteries, create holes on the side of the box large enough for your water-tight connectors and run your wires in from the side to make room for the battery.

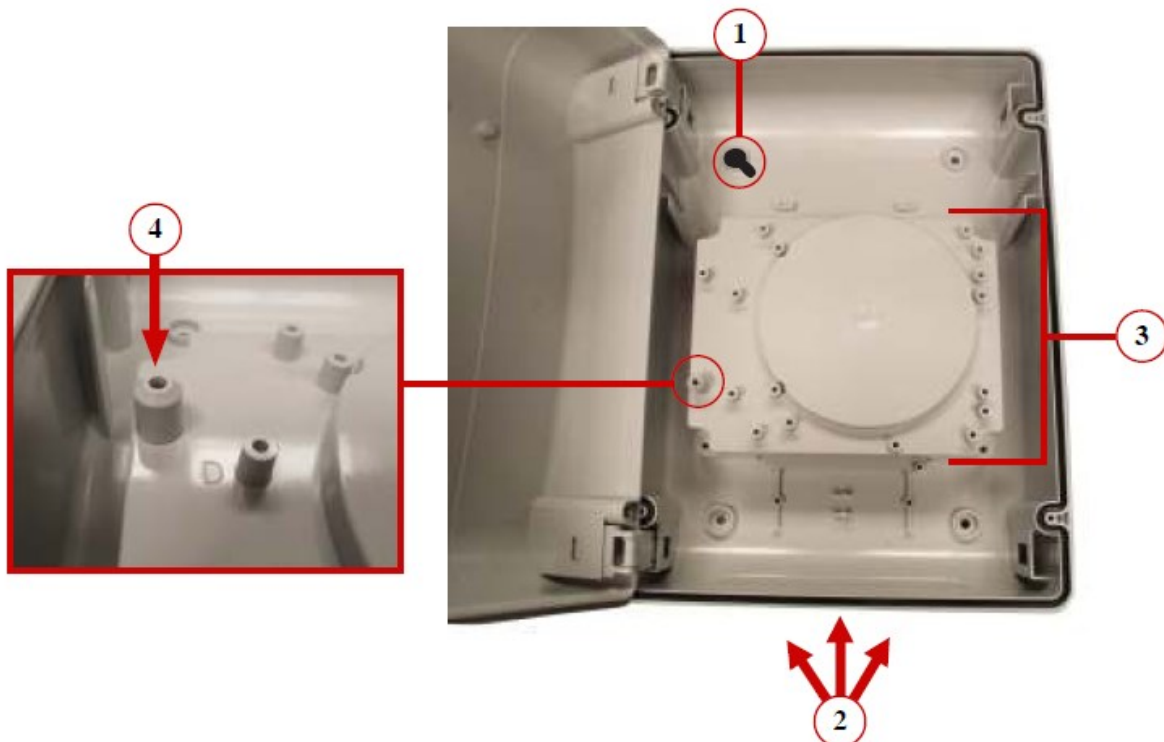

Position Backup Batteries

1. Slide the two batteries below the control board mount. They do not require any additional bracing.

Create holes on the side of the box large enough for your water tight connectors and run your wires in from the side to make room for the batteries.



For Your Convenience

The white terminal strips on the control board are easily removed for wiring. Simply pull straight out on the terminal strip to remove it from the board. It will slide right off. Slide it back on when you are finished with your wiring connections.

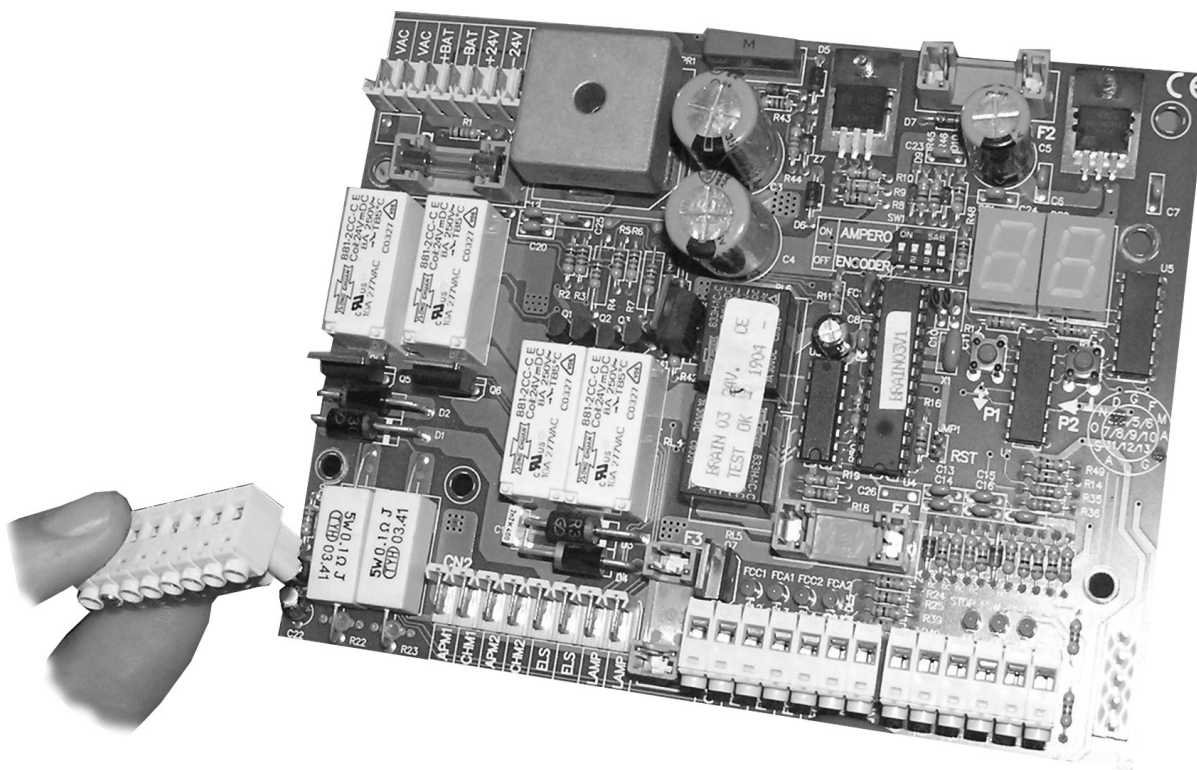

Wiring the Operator Arm(s)

Attaching Arm Cover

1. Fit the bottom cover with the supplied cable gland.
2. Run the 5 Conductor wire through the cable gland and tighten the cable gland to squeeze the wire.
3. After attaching the wire according to the picture below and the chart on the following page, cover the operator arm terminal board with the bottom cover.

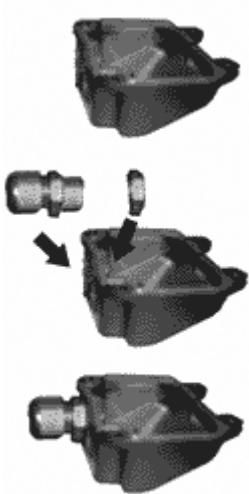

Use the following page in conjunction with this picture to correctly wire your arm(s).

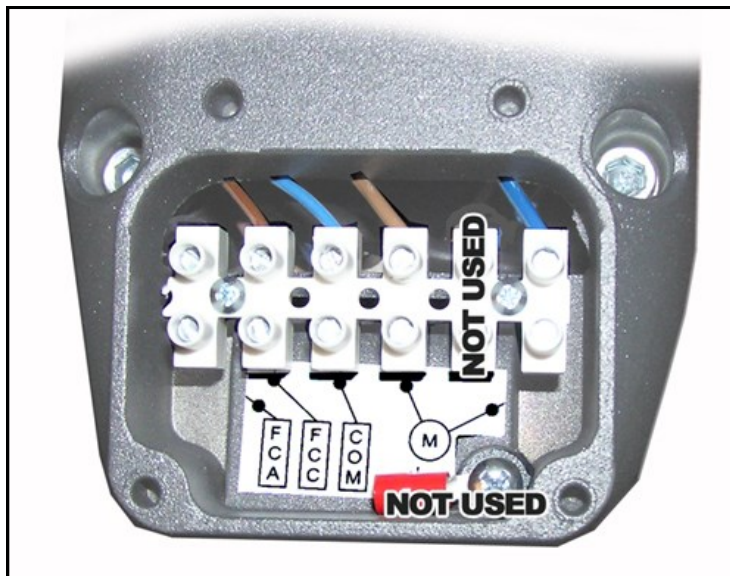
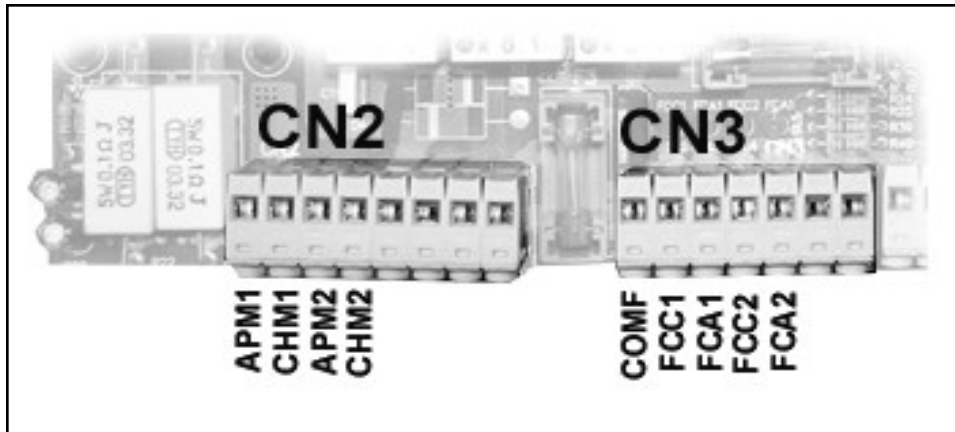

Wiring the Operator Arm(s)

1. Locate the wiring terminal board on the bottom of the operator arm(s).

2. Wire the operator arms according to the diagram below.

NOTE: 1 indicates Master arm or Single operator connections, 2 indicates Slave arm if applicable and is not used in single gate installations.

Wiring Connections for Operator Arm Power.					
Position from right in arm	Color Inside Arm	Arm to Board Wire Color	Terminal Purpose	Board Terminal Block	Board Connection Terminal
M	Red	Red/White Lg. Wire	Power	CN2	APM1 (master) APM2 (slave - if dual)
M	Black	Black/White Lg. Wire	Power	CN2	CHM1 (master) CHM2 (slave - if dual)
COM	Yellow	Yellow Sm. Wire	Limit Common	CN3	COMF (For both master and slave- if dual)
FCC	Red	Red Sm. Wire	Limit Closed Position	CN3	FCC1 (master) FCC2 (slave - if dual)
FCA	Black	Black Sm. Wire	Limit Open Position	CN3	FCA1 (master) FCA2 (slave - if dual)

NOTE: Ground Terminal Screw indicates right from left as seen in picture on previous page, the ground terminal screw however is not used on this model.

There is an Illustration to match the above chart on the previous page.

Push-To-Open wiring is found on the next page.



We have recently changed provided wire colors. If your wire colors do not match the chart above and you need help determining terminal placement, call 1-800-640-GATE for assistance.

Wiring the Operator Arm(s) for Push To Open

1. Locate the wiring terminal board on the bottom of the operator arm(s).
2. Wire the operator arms according to the diagram below.

Wiring Connections for Operator Arm Power.					
Position from right in arm	Color Inside Arm	Arm to Board Wire Color	Terminal Purpose	Board Terminal Block	Board Connection Terminal
M	Red	Red/White Lg. Wire	Power	CN2	CHM1 (master) CHM2 (slave - if dual)
M	Black	Black/White Lg. Wire	Power	CN2	APM1 (master) APM2 (slave - if dual)
COM	Yellow	Yellow Sm. Wire	Limit Common	CN3	COMF (For both master and slave- if dual)
FCC	Red	Red Sm. Wire	Limit Open Position	CN3	FCA1 (master) FCA2 (slave - if dual)
FCA	Black	Black Sm. Wire	Limit Closed Position	CN3	FCC1 (master) FCC2 (slave - if dual)

NOTE: 1 indicates Master arm or Single operator connections, 2 indicates Slave arm if applicable and is not used in single gate installations.

The main difference with Push To Open is the matching of column 1 with column 6 in the chart above. Note how the FCCs no longer match up and the FCAs don't either, also the power leads are swapped.



We have recently changed provided wire colors. If your wire colors do not match the chart above and you need help determining terminal placement, call 1-800-640-GATE for assistance.

Temporary Safety Jumpers

For the highest level of safety, the Estate Swing systems are set up with Normally Closed safety terminals. This means that in order for the gate opener to move these terminals must be closed either through a safety device (recommended) or with jumpers. Temporary safety jumpers are provided in the control box hardware bag for jumping these terminals to common (COM) during the set-up process.

It is recommended not to use any accessories until setup and programming are complete.

NOTE: If not using safety devices the temporary safety jumper must remain in. In order for the gate operator to move, all three safety terminal lights (STOP, FSW CL, FSW OP) must be lit.

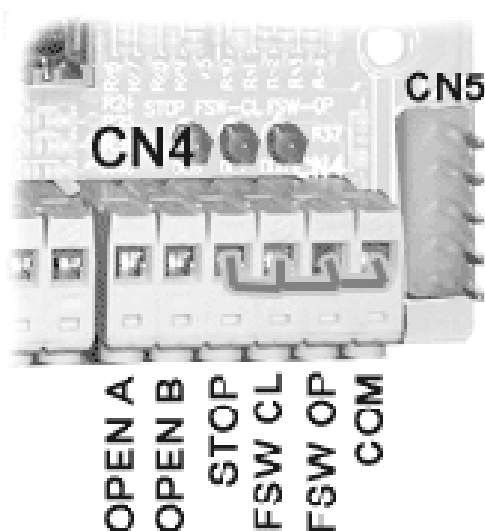

Power

1. The Estate Swing E-S 1600 comes with 1) 24V transformer. The transformer supplied has 2 screw terminals to connect to. You may locate the transformer up to **144' (single) or 72' (dual) away from the control board using 2 conductor stranded direct burial wire as specified below.**

Single (1600)

- 0-36 Feet - Use 16 Gauge
- 37-57 Feet - Use 14 Gauge
- 58-91 Feet - Use 12 Gauge
- 92-144 Feet - Use 10 Gauge

Dual (1602)

- 0-18 Feet - Use 16 Gauge
- 19-29 Feet - Use 14 Gauge
- 30-45 Feet - Use 12 Gauge
- 46-72 Feet - Use 10 Gauge

2. Insert the two wires from the transformer into the two VAC terminals on the control board (CN1). The wires are not polarized, there is no positive or negative. **Do not splice the power cable wire.**



Never run 110VAC power directly to the Estate Swing. This will destroy the Estate Swing control board.

Allow a minimum of 4' of wire between the control board and the transformer.

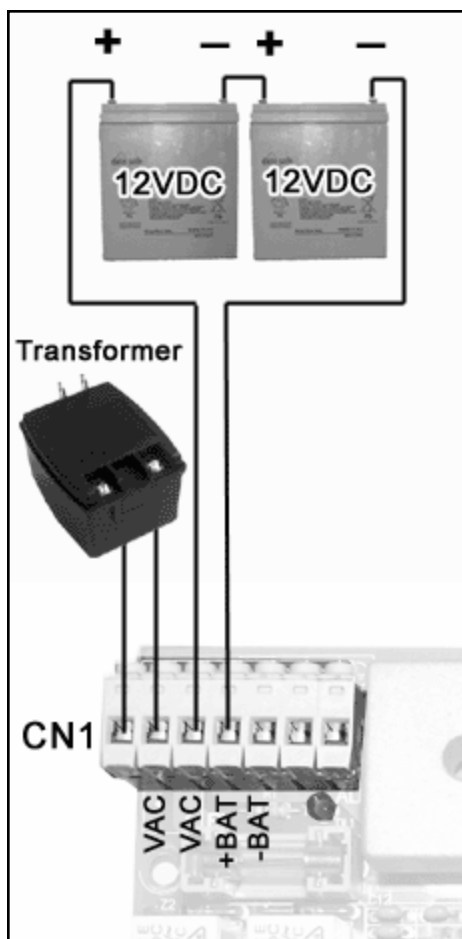

Never connect the power wire with the transformer plugged in. Contact between the two lead wires, even for a second, will destroy the transformer.

Transformers are only warranted if the internal fuse is not blown. If the fuse is blown an outside factor (shorting, surge, water, etc) has caused the transformer not to function.

3. Plug the **transformer** into a 110 V AC outlet.
4. The transformer is not weather proof and must be kept in a covered area. *Plug covers are available from your dealer, contact 1-800-640-GATE for a dealer in your area.*
5. Two 12V DC batteries may be run in series as backup to the 24V transformer power. Running two 12V batteries (Max 5 a/h per battery) in series creates a 24V system, ***you cannot run them in parallel (see diagram to the left)***
6. The power light located below the +24V and -24V output terminals will be on if the power is connected properly. If the light is off then power through the transformer is not functioning properly and either the unit has no power or is on battery backup. *The light stays off during battery backup.*

Estate Swing 433 Plug-in Receiver

1. With the red plug already inside the control box, run the grey receiver wire out of the box through one of the water tight connections.
2. Find a location for the receiver box on the gate post or a fence post that is within the length of the receiver wire.
3. Using a #6 screw attached the top of the receiver to the post. If you are happy with this position use the small provided set screw in the bottom hole to secure the receiver in place.
4. Attach the receiver wire to the terminals as seen below. Please note that you will find a factory installed jumper wire connected on the receiver. Leave this jumper wire in place. One of the terminals that has the jumper wire will have the White wire added to the terminal.

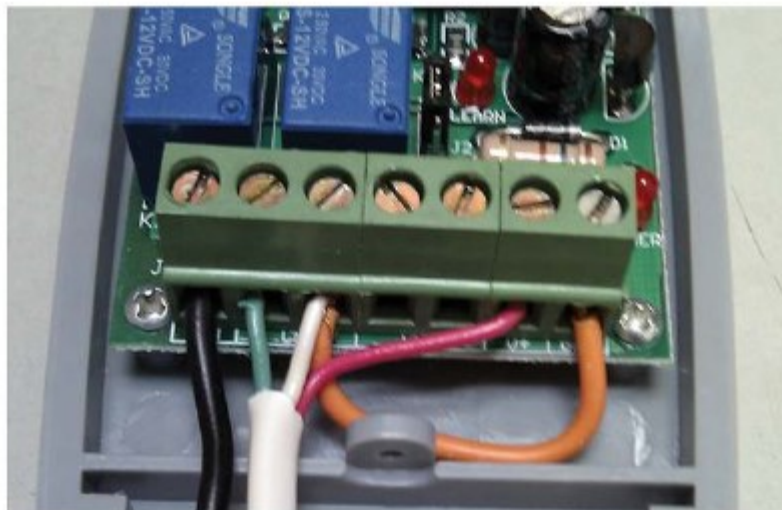

Green = CH1 White = CH1 Red=V+

Estate Swing 433 Plug-in Receiver (cont.)

5. Plug the white clip inside the control box into the control board. The groove in the white clip should snap into the guide on the 5 prong connector. (Fig 1)

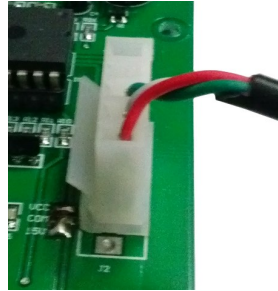

Fig. 1

6. The red power light should come on the receiver. (Fig 2)

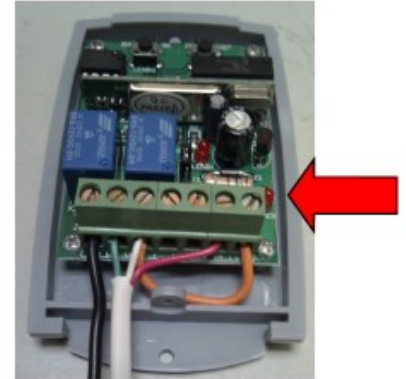

Fig. 2

7. Program your remotes to the receiver:

A. Press and release the LEARN1 button at the top of the receiver board (ex 1). The learn LED will illuminate steady (ex 2). (Fig 3)

B. Press and hold the button on the remote you wish to program to the receiver.

C. Hold the remote button until the Learn LED flashes and then turns off. (caution your gate opener may be triggered during this process)

D. Repeat A through C for all additional remotes.



Fig. 3

NOTES ABOUT REMOTES:

You can program up to 400 codes into the receiver. This could mean 1 button on 400 different remotes or this could mean all 4 buttons on 100 remotes or anything in between. Some choose to program all 4 buttons to a single receiver if they are not using multiple gates to eliminate pressing the incorrect button on the remote. To do so follow the programming above with each button of the remote. You can erase all programmed codes by holding Learn 1 until the Learn LED comes ON and then turns OFF.

8. Put the cover on the receiver and secure it in place using the provided screw.

IMPORTANT: The receiver is a drip proof receiver. This means that it is designed to prevent water from accessing the inside of the receiver when the water is moving downward with gravity (rain for example).

DO NOT mount the receiver anywhere that water may access it from another angle. For example: Do not mount near sprinklers. Do not mount the receiver horizontally. Do not mount the receiver near a flat surface where water could splash upwards.

Setting Operating Parameters



Complete this step prior to programming the gate run time. This will dictate how your gate will react during programming and normal operation.

It is not necessary to reset these if power is removed or if reset is tripped, they will stay set.

Important Dip Switch Setting

Verify the 4 dipswitches to the left of the display LED are as follows:

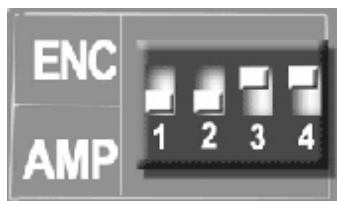

1. DOWN
2. DOWN
3. UP
4. UP

Entering programming mode

1. Make the necessary power connections and check the LED lights to be sure the appropriate lights are lit.
2. The display should show --
3. Press and hold down **P2** until the display shows parameter A with the corresponding number that is currently default or previously programmed.
4. Press **P1** to change the number variable of the parameter, **USE THE CHART ON THE NEXT PAGE AS A GUIDE.**
5. To move to the next parameter, Press **P2**.
6. When 60 seconds have elapsed without any button being pressed the control unit automatically exits the programming mode. To exit manually, Press **P2** to scroll through all the parameters until the display shows --

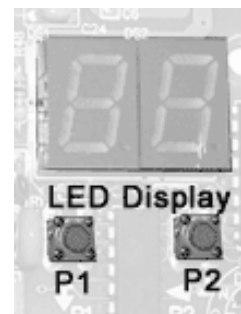

Operating Parameters Chart

<u>A 1</u>	Minimum Force	FORCE	This parameter adjusts the sensitivity of the electronic clutch system. The electronic clutch system controls the anti-crushing auto-reverse feature when a gate in motion makes contact with an obstacle.
<u>A 2</u>	Medium-low Force		
<u>A 3</u>	Medium-high Force		
<u>A 4</u>	High Force		
<u>b 1</u>	1.5 Second Offset	DELAY	This parameter is for Dual gate opener systems ONLY. This determines how long the second leaf will pause before moving to allow the first leaf to separate and avoid obstructing on the other leaf. If using a Single gate opener system, the setting will not affect your gate.
<u>b 2</u>	3 Second Offset		
<u>b 3</u>	6 Second Offset		
<u>b 4</u>	10 Second Offset		
<u>c 0</u>	Disabled	AUTO-RECLOSE	This parameter turns auto-close on or off. The pause time for the auto-close is set during movement programming.
<u>c 1</u>	Enabled		
<u>d 0</u>	Opens/Closes/Opens...	OPEN A	This parameter determines what an OPEN A terminal command will result in. d1 is recommended for safety.
<u>d 1</u>	Opens/Stops/Closes/Stops...		
<u>E 0</u>	Disabled	CONDO	This parameter is for use with multiple gate users. If enabled, when the gate is opening it can not be reversed by another open signal.
<u>E 1</u>	Enabled		
<u>F 0</u>	Disabled	OVER-PUSH	This parameter is for use with electric gate locks. The gate will briefly push further closed before opening to allow the lock to release.
<u>F 1</u>	Enabled		
<u>G 0</u>	Flashing Lamp	LAMP	This parameter is to determine between a flashing or steady lamp. If not using a lamp the setting will not affect your gate.
<u>G 1</u>	90 Second Courtesy Light		

Continued on following page.

<u>H 0</u>	20% of total arch	SOFT START/ STOP	This parameter determines when the gate will begin to slow down near the end of opening and closing cycle.
<u>H 1</u>	10% of total arch		
<u>1 0</u>	Low	SOFT SPEED	This parameter determines how fast the gate will move during the soft start/stop. If using positive stops it must be set to 0.
<u>1 1</u>	High		
<u>L 0</u>	No Limit Switch	LIMIT SWITCH	In this parameter you MUST specify whether you are using limit switches or not for proper function of your gate.
<u>L 1</u>	Limit Switch		
<u>P 1</u>	Single Leaf Gate	SINGLE OR DUAL	In this parameter you MUST specify whether you are using single gate (one leaf - one motor) or dual gate (two leaves - two motors).
<u>P 2</u>	Dual Leaf Gate		



Press P2 one more time to exit this mode. After setting your last parameter you must now move on to programming your gate run times. Programming instructions begin on the next page.

Your opener arm(s) will not move prior to completing gate run time programming.

Programming Gate Run Times

**In this stage, your control board will memorize where your limits are (identified by limit switches, positive stops or both) in both opening and closing phases. Also if the auto-close feature is activated it will learn the user specified pause time.
FOR SAFETY PURPOSES—your opener will not run until this step is completed**

1. Release the operator gears using the manual release process. Once released, manually move the gate(s) half way between the open and close stop points.

2. Relock the operator gears at the half way point through its cycle.

3. Verify your operator control board is showing **--** on the LED display by touching the TWO reset pins as in the graphic below.

HINT: Using a flat head screwdriver, place it between the two pins and turn until contact is made with both.

4. Press and hold down **P2** until the LED display shows the A parameter and the relevant number appear in the LED display.

5. Give an **OPEN A** command. This can be done with any opening device (keypad, push button, etc...) wired into OPEN A and COM or using the transmitter. *You can also briefly (one second or less) jump OPEN A and COM with a wire.* This will begin your gate in the **CLOSING DIRECTION** and the **LED display** will read **"Pr"**.

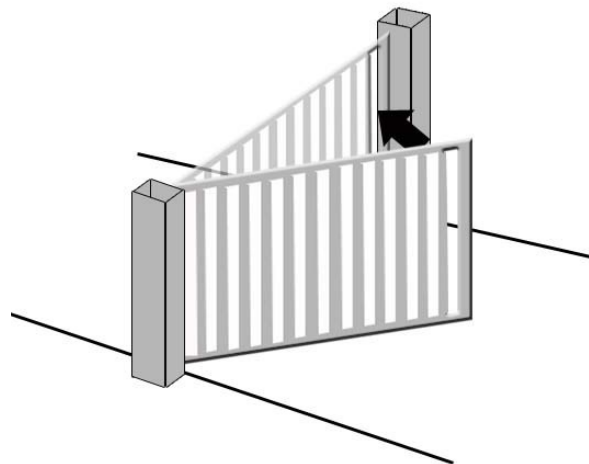
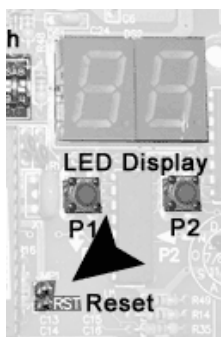
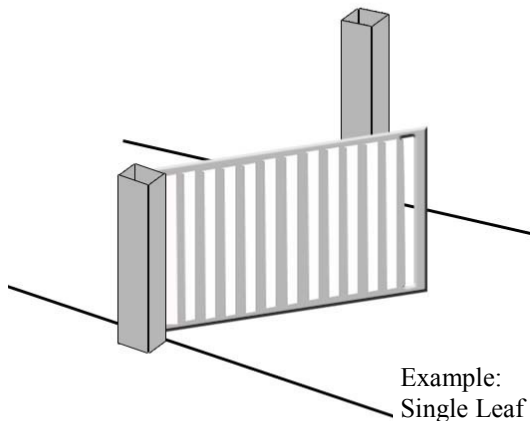

IMPORTANT: If the gate(s) begin to open rather than close, the gate(s) must be stopped with a reset pulse.

You can either:

Touch the TWO pins of the JMP "RESET" using a screwdriver **OR**
Disconnect all power (transformer and backup battery)

Then switch the wires leading into APM1-CHM1 (if Dual Operator APM2-CHM2 also) and then begin programming again.

5. When the closing stop point or limit switch is reached, the motor pauses for approximately 2 seconds, and then restarts with a total opening maneuver to the opening stop point or limit switch.

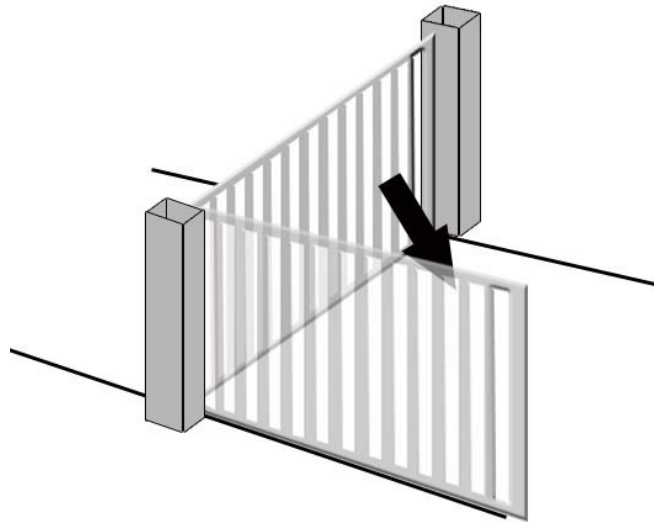

6. When the full open stop or limit switch is reached the gate(s) will stop.

7. Wait for the amount of time you would like your gate(s) to pause for (up to 4 minutes) during normal operation before automatically re-closing and then signal your opener using an OPEN A contact or transmitter signal to close the gate(s). The gate(s) will then return to closed and programming will be complete.

Even if your auto close is off you must still set a pause time, the pause time will not be used in normal gate operation.

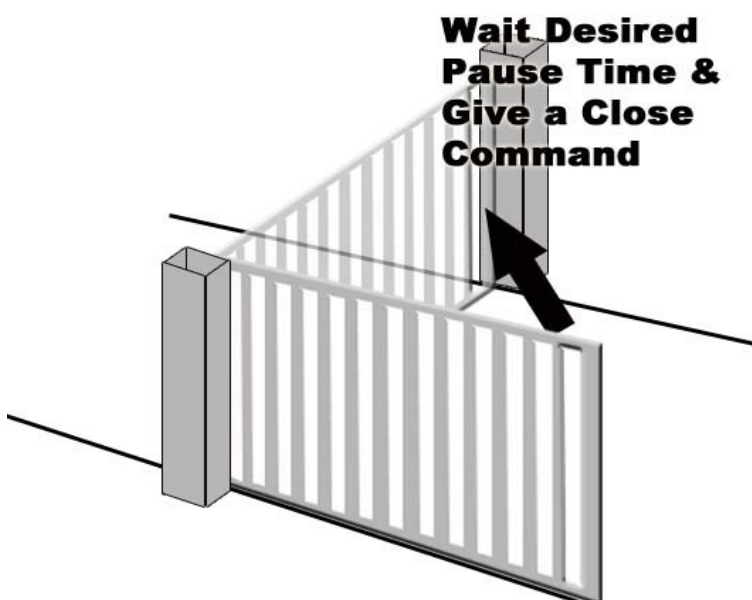

Dual gates are programmed simultaneously. Move both of the leaves to the same starting position and both leaves will move together through the same programming sequence. There is a slight starting delay on the slave side.

LED Lights & Operational Displays

Control Board LED Lights - The control board LED lights are located above their respective terminals that they represent. (With exception of ALIM, power supply light, which is located below the power terminals in the upper left corner.) The LED lights are a quick way of verifying necessary connections are made. Below is a chart of their interpretations.

LED	ON	OFF
ALIM	Powers supply by transformer	Power supply by battery or no power
FCC 1	Motor 1 closing limit switch - not tripped	Motor 1 closing limit switch - tripped
FCA 1	Motor 1 opening limit switch - not tripped	Motor 1 opening limit switch - tripped
FCC 2	Motor 2 closing limit switch - not tripped	Motor 2 closing limit switch - tripped
FCA2	Motor 2 opening limit switch - not tripped	Motor 2 opening limit switch - tripped
STOP	Stop command - not activated	Stop command - activated
FSW CL	Closing safety device - not tripped	Closing safety device - tripped
FSW OP	Opening safety device - not tripped	Opening safety device - tripped



During idle (closed and waiting on command) for single gate openers, all should be on except FCC1, FCC 2, and FCA 2.

During idle for dual gate openers, all LED lights should be on except for FCC1 and FCC2.

If not using safety devices , you must jump STOP, FSW CL and FSW OP to COM in order for the gate opener to function.

Standard Operation Display - This is when the gate opener is not in parameter setting mode or programming mode. LED displays DS1 and DS2 will show the following:

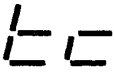
Gate Status

- — Gate At Rest in Closed Position
-  Gate Opening or Gate Open when Auto Close is OFF
-  Gate open in pause status
(Only with automatic re-close enabled - Parameter c)
-  Gate Closing

Troubleshooting

If the gate opener will not move.

Be sure you have gone through programming. Without programming no power is ever sent to the operator arms.

Check wiring connections.

Check to be sure jumpers are in place between STOP, FSW OP, FSW CL to COM on terminal block CN4.

If not using limit switches, be sure jumpers are in place between FCC1, FCA1, FCC2, FCA2 to COMF on terminal block CN3.

Be sure the arms are locked out of manual operation.

Check all fuses, the fuses protect as follows but all are required for the arms to move:

F1: 10A – Power Supply, 24VAC

F2: 630 mA – Power supply to accessories and battery charger

F3: 630 mA – Flashing lamp output

F4: 3.15A – Electric Lock Output

If the gate opener move a few inches or feet and stops or reverses directions.

Check dip switches to the left of the LED display. It should be 1:OFF, 2:OFF, 3:ON, 4:On. If the dip switches are wrong, you **must** turn all power off before changing the dipswitches and then turn power back on for the settings to take effect.

Increase the force setting to the highest force. The force setting is the A parameter, move the A parameter to 4. If the gate moves fully after doing so you may then work your way down force settings to the lowest force setting that the gate still moves correctly under.

Check the setback. The setback of the operator is important to correct operation due to leverage the arm will have on the gate.

If using limit switches, check limit switch placement and wiring. You can tell if a limit switch has been triggered by watching to see if one of the lights above FCC1, FCA1, FCC2, FCA2 go unlit. Whichever limit light is unlit is engaged.

Continued on next page.

If fuse the F2 fuse blows or continues to blow.

Check all wiring to both the backup batteries and to all accessories run off of the 24+, - terminals on terminal block CN1. Check for the following:

- The batteries are run in **series** not parallel. If they are run in parallel the batteries will become overcharged and be destroyed, which will then create a short and continually blow the F2 fuse.
- The accessories going into 24V+, - must have the correct polarity.
- The accessories going into 24V+, - cannot exceed a combined power draw of more than 500 mA.

Check the battery voltage, if the battery voltage is very low you may have dead cells in the battery causing an overdraw of current and blowing the fuse. Replace the batteries.

If the gate reaches it's closed position during the learning process but does not re-open.

Touch the reset pins (RST) to reset the system. Change the i parameter to 0. Restart the learning process.

Contact Estate Swing for alternate power supply to correct a lack of correct voltage and/or amperage outputs under load.

The gate does not reach the desired stop points.

If not using limit switches:

- Be sure the arm can go full expected range. Manually release the arms and move the gates by hand to possible range. Do not let the arm reach its physical limitations before the stops during normal operation.
- If arms can't extend full expected range, check the setback. 6 ½ x 6-½ inch setback is the correct setback for a 110-degree opening.
- If the opener arm has the physical possibility of opening yet still stops, increase the force setting to the highest force. The force setting is the A parameter, move the A parameter to 4. If the gate moves fully after doing so you may then work your way down force settings to the lowest force setting that the gate still moves correctly under. The ending positions are where the most stress is put on the arm and the leverage is the lowest.

If using limit switches:

- Check limit switch placement and wiring. You can tell if a limit switch has been triggered by watching to see if one of the lights above FCC1, FCA1, FCC2, FCA2 go unlit. Whichever limit light is unlit is engaged.
- If limit switches are to the furthest points possible on both the closed and open positions, check the setback. 6 ½ x 6-½ inch setback is the correct setback for a 110-degree opening
- If the opener arm has the physical possibility of opening yet still stops, increase the force setting to the highest force. The force setting is the A parameter, move the A parameter to 4. If the gate moves fully after doing so you may then work your way down force settings to the lowest force setting that the gate still moves correctly under. The ending positions are where the most stress is put on the arm and the leverage is the lowest.



If you call in for technical support or warranty support: before any control board or motor will be permitted to be sent in for testing or warranty you will be required to e-mail digital photos to the technician.

This is done in your best interest to save unnecessary shipping expenses and time lost. Many times we can come up with solutions to issues by seeing pictures that relay information that is impossible to relay through a phone conversation.

Below are examples of control board pictures and motor pictures that we will be looking for:

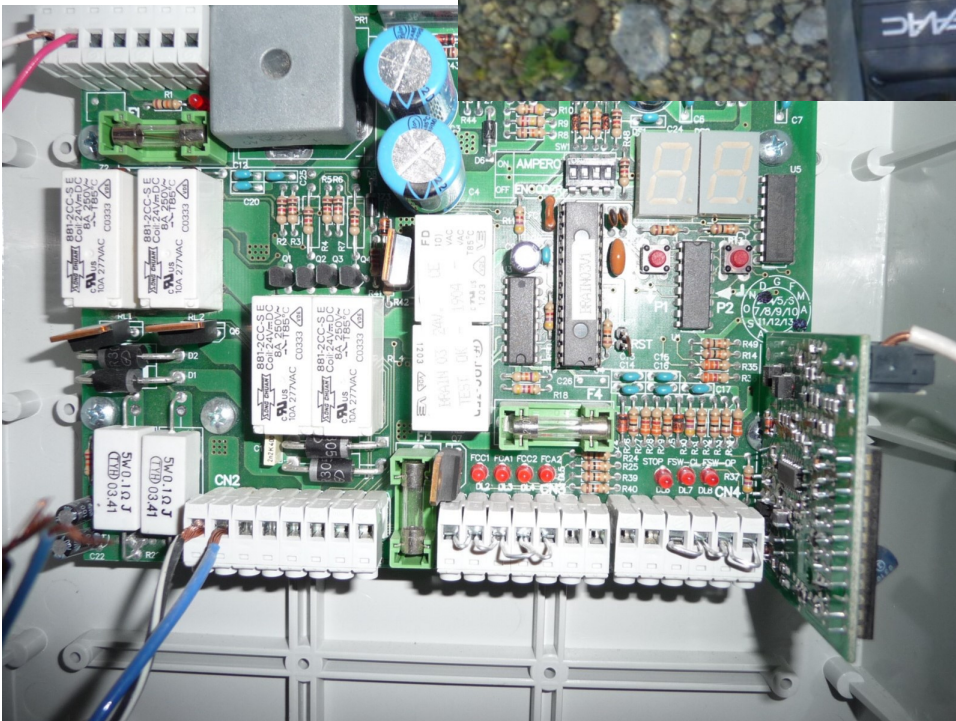

Control Board Overview



Caution! Do not run 110V AC power direct to the board. This will cause permanent damage to both boards and void your warranty. **Caution!**

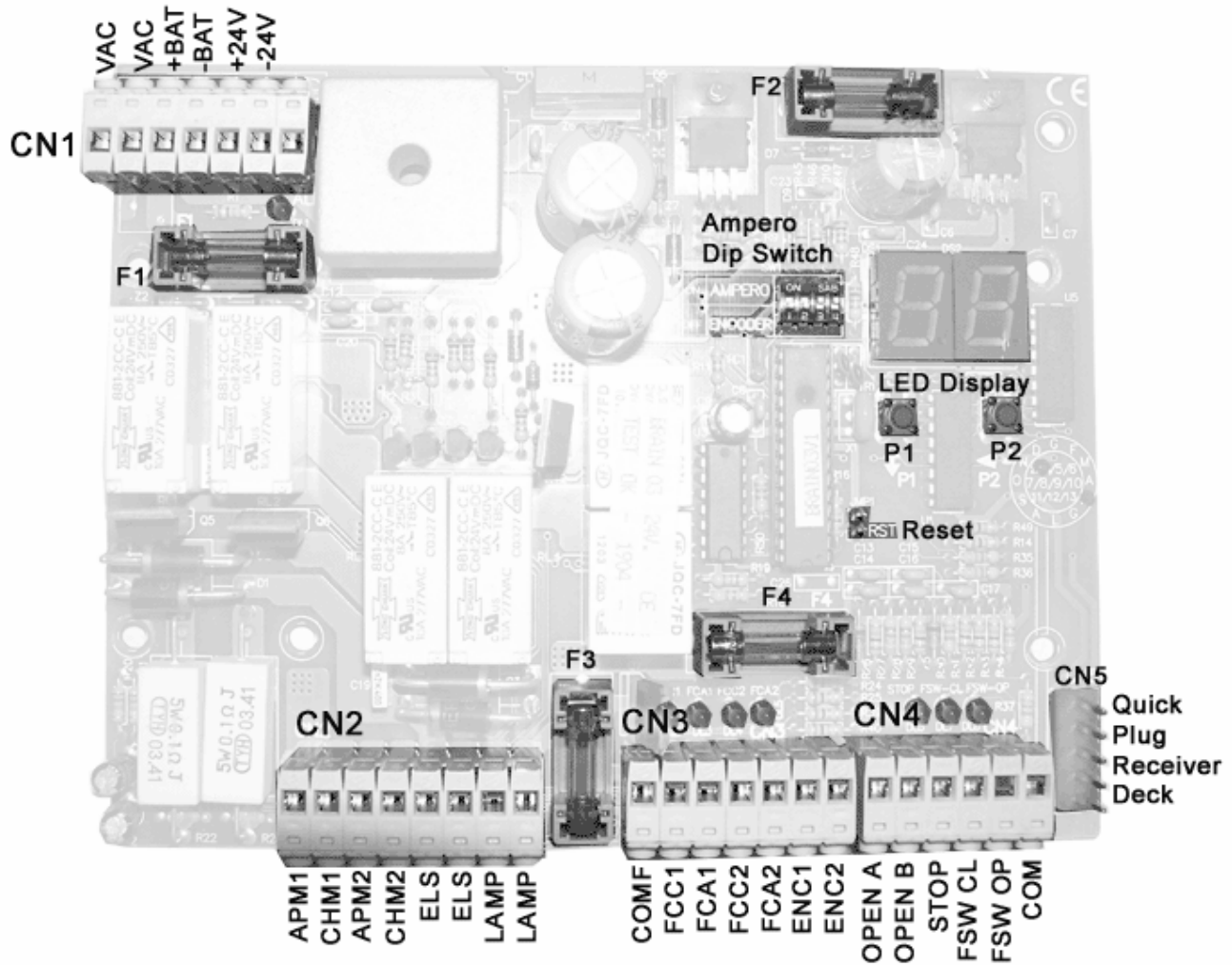

CN1 - Upper left hand corner of board, used for power and back up power.

- **VAC - terminals.** The input terminals for the supplied 24V transformer. Polarity is not an issue for this terminal.
- **+BAT, -BAT - terminals.** Input terminals for the optional backup batteries. The battery power coming in must be 24V DC. This can be achieved by running two 12V batteries (Max 5 a/h per battery) in series. During normal operation, the unit keeps the batteries charged and the batteries begin operating the unit if no power is being supplied through terminals VAC. Observe polarity on these terminals.
- **+24, -24 - terminals.** Accessories needing constant 24V power should be attached to these terminals following the correct polarity. (Example: Alternate receiver, exit wand)

Continued on following page.

CN2 - Located on the lower left side of the board, these terminals are outputs for the operator arm(s), gate locks (optional), and lamps (optional).

- **APM1, CHM1 - terminals.** For dual operations these terminals are for the arm that must move first, for single operations these terminals are the output for controlling the operator arm.
- **APM2, CHM2 - terminals.** For dual operations **ONLY**. Connect the arm that is to move second to these terminals. For single operations nothing should be connected to these terminals.
- **ELS - terminals.** Brief 24V output at beginning of operation cycle, meant for release an electric lock.
- **LAMP - terminals.** Both a flashing lamp and a courtesy lamp can be connected to these terminals with a power supply of 24V DC and a max output of 15 W. to change between flashing lamps and courtesy lamps, select parameter “G”.

CN3 - Located on the center bottom of the board, these terminals are for limit switches.

- **COMF - Common terminal** to make the needed normally closed connections for the limit switches.
- **FCC1 - Normally closed contact.** This terminal is connected with the COMF through the limit switch. When tripped (connection opened) it stops the motion of the first operator. ***(If not being used, this terminal must be jumped with COMF)*** **Master Closed Limit Switch**
- **FCA1 - Normally closed contact.** This terminal is connected with the COMF through the limit switch. When tripped (connection opened) it stops the motion of the first operator. ***(If not being used, this terminal must be jumped with COMF)*** **Master Open Limit Switch**
- **FCC2 - Normally closed contact.** This terminal is connected with the COMF through the limit switch. When tripped (connection opened) it stops the motion of the second operator. ***(If not being used, this terminal must be jumped with COMF)*** **Slave Closed Limit Switch**
- **FCA2 - Normally closed contact.** This terminal is connected with the COMF through the limit switch. When tripped (connection opened) it stops the motion of the second operator. ***(If not being used, this terminal must be jumped with COMF)*** **Slave Open Limit Switch**
- **ENC1, ENC2 - terminals. NOT USED**

CN4 - Located on the bottom right of the board, these terminals are for accessories and safety devices.

- **OPEN A - terminal.** This is the most common terminal for accessories. Accessories utilizing a normally open contact to set the gate in motion will be attached to this terminal and the COM terminal (common or also know as ground).
- **OPEN B - terminal.** This terminal is for opening the first leaf only in dual gate operations. It is a normally open contact that must be used in conjunction with the COM terminal.
- **STOP - terminal.** This is a normally closed terminal that is used for gate motion stopping emergency commands. **If a safety device is not being used in this terminal the operator must have a jumper ran from this terminal to the COM terminal in order to operate.**
- **FSW CL, FSW OP - terminals.** These normally closed terminals are for safety devices during the closing (CL) and opening (OP) cycles of the gate. **If a safety device is not being used in this terminal the operator must have a jumper ran from this terminal to the COM terminal in order to operate.**
- **COM - terminal.** This is a common, or sometimes referred to as ground, terminal. It is used in conjunction will **ALL** accessories and safety devices.

Photocell & Safety Device Guide

Before connecting the photocells (or other devices) we advise you to select the type of operation according to the movement zone to be protected.

Opening Safety Devices: They operate only during the gate opening movement and, therefore, they are suitable for protecting the zone between the opening leaves and fixed obstacles (walls, etc.) against the risk of impact and crushing.

Closing Safety Devices: They operate only during the gate closing movement and, therefore, are suitable for protecting the closing zone against the risk of impact.

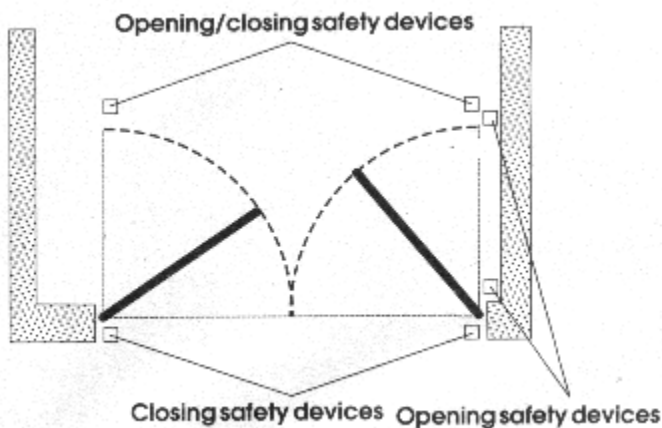

Opening/Closing Safety Devices: they operate during the gate opening and closing movements and, therefore, they are suitable for protecting the opening and closing zones against the risk of impact.

If one or more devices have the same function (opening or closing) they must be connected to each other in series. Normally Closed contacts on the accessories panel must be used.

Accessories Wiring

The manufacturer instructions that come with your accessory should have markings for wires or terminals to connect to the gate opener. Please look for terminals named below in the instructions for the accessory.

Keypads, Receivers:

- **Normally Open (NO) or Input (INP) or Relay of entry device** = OPENA terminal of CN4 block on gate opener control board.
- **Common (COM) or Ground (GND) or Relay of entry device** = COM terminal of CN4 block on gate opener control board.

NOTE: If the power for the accessory shares a Ground wire/terminal with the relay – Do Not power that accessory off this control board (example: WKP-P keypad). Instead power that device with batteries.

- **24V Power positive (+) or (24V) or (PWR) of entry device** = +24V terminal of CN1 block on gate opener control board.
- **24V Power Negative (-) or (GND) or (PWR) of entry device** = -24V terminal of CN1 block on gate opener control board.

Push Button, Intercoms:

- **Normally Open (NO) or Input (INP) or Relay of entry device** = OPENA terminal of CN4 block on gate opener control board.
- **Common (COM) or Ground (GND) or Relay of entry device** = COM terminal of CN4 block on gate opener control board.

Push buttons do not require power and Intercoms draw too much power to power from the gate opener.

Exit Wand/Sensor, Exit Loop Detector, Exit Device:

- **Normally Open (NO) or Input (INP) or Relay of exit device** = OPENA terminal of CN4 block on gate opener control board.
- **Common (COM) or Ground (GND) or Relay of exit device** = COM terminal of CN4 block on gate opener control board.
- **24V Power positive (+) or (24V) or (PWR) of exit device** = +24V terminal of CN1 block on gate opener control board.
- **24V Power Negative (-) or (GND) or (PWR) or Shield wire of exit device** = -24V terminal of CN1 block on gate opener control board.

Accessories Wiring

Photo Eye, Safety Edge, Safety Loop:

- **Normally Closed (NC) of safety device** = FSW CL terminal of CN4 block on gate opener control board.
- **Common (COM) or Ground (GND) of safety device** = COM terminal of CN4 block on gate opener control board.
- **24V Power positive (+) or (24V) or (PWR) of safety device** = 24V+ terminal of CN1 block on gate opener control board.
- **24V Power negative (-) or (GND) or (PWR) of safety device** = 24V- terminal of CN1 block on gate opener control board.

**Remove safety jumper from FSW CL terminal if using a safety device.*

Solenoid Gate Lock:

- **Positive Lead of lock** = ELS terminal of CN2 block on gate opener control board.
- **Negative Lead of lock** = ELS terminal of CN2 block on gate opener control board.
- **Magnetic Gate Lock:** Magnetic gate locks must have their own power supply and their own relay.
- **Coil of relay for magnetic lock** = ELS terminal of CN2 block on gate opener control board.
- **Coil of relay for magnetic lock** = ELS terminal of CN2 block on gate opener control board.

Connect positive lead of the power supply directly to the positive lead of the mag lock.

Connect negative lead of the power supply to the N/C terminal of the relay.

Connect the COM terminal of the relay to the negative lead of the mag lock.