



Eagle Access Control Systems, Inc.

12953 Foothill Blvd.

Sylmar, CA 91342

Tel: 818-837-7900 Fax: 818-837-7911

Toll Free: 800-708-8848

www.EagleOperators.com

Slide Gate Operators / Eagle I

The Fail Secure System

The Fail Secure System allows you to manually open the gate with a use of a crank in case of an emergency. If a situation does arise, simply turn off the power switch and insert the crank at the opening on the side of the operator. As you continually turn the crank the gate will open. DO NOT try to crank the gate open when power is engaged.

Optional Release Procedure

Using the Eagle-2070-Fire Box

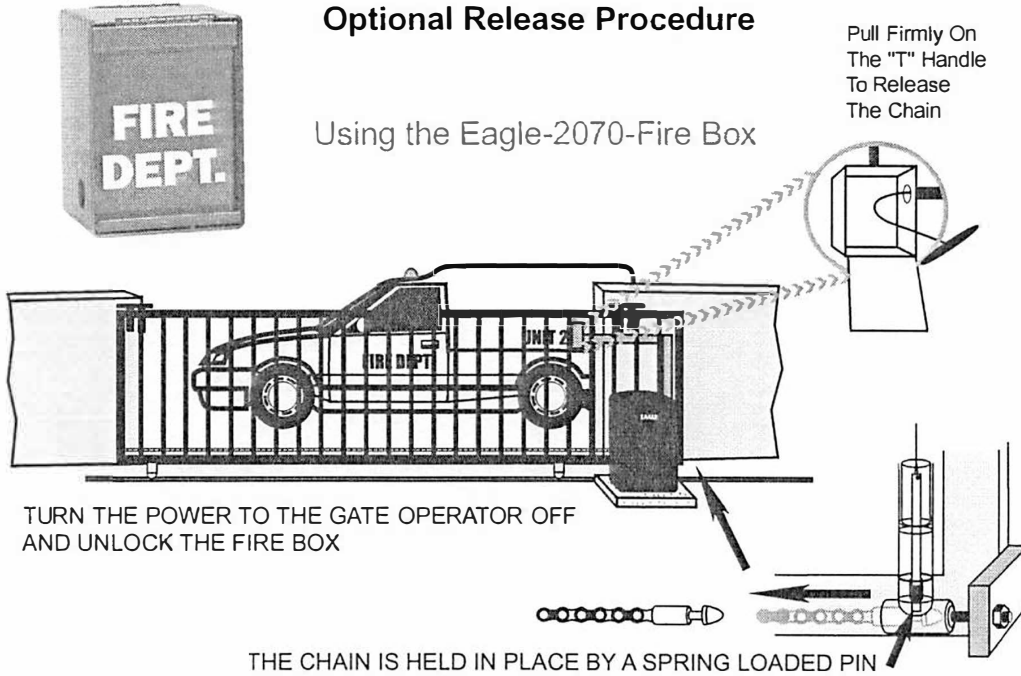

Mounting The Secondary Entrapment

Note: Eagle Access Control Systems, Inc. recommends the installation of Edge Sensors on all sliding gate operator systems.

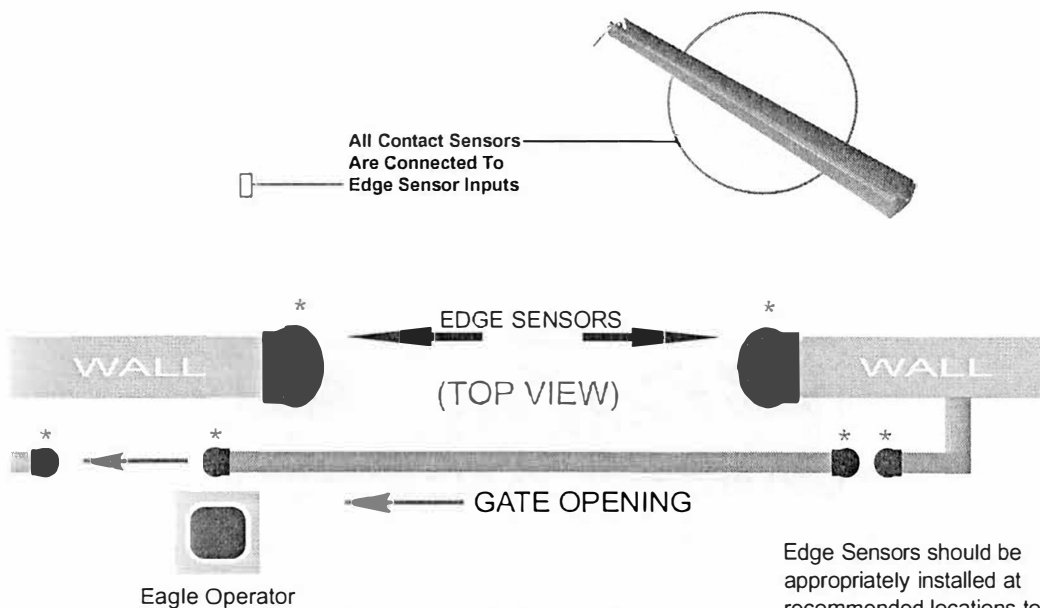

* All Edge Sensors are shown at recommended locations.

Edge Sensors should be appropriately installed at recommended locations to ensure proper entrapment protection against injury.

Receiver Connections

The Receiver Terminal is mounted on the control box for easy installation and is pre-wired for a 3-wire or 4-wire receiver.

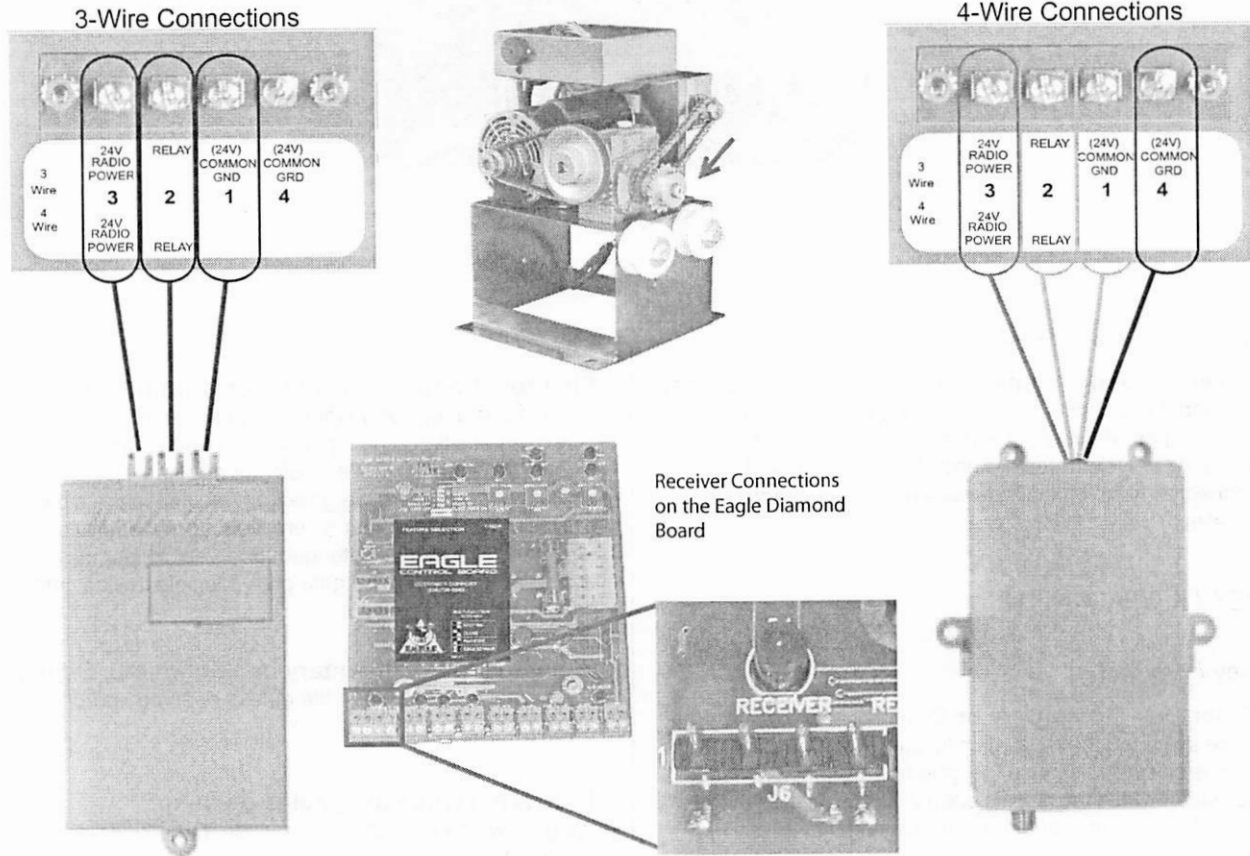

Gate Travel Distance / Setting The Limit Switches

The limit switches must be set so that the gate stops at the proper position. Follow these instructions to appropriately set the limit switches.

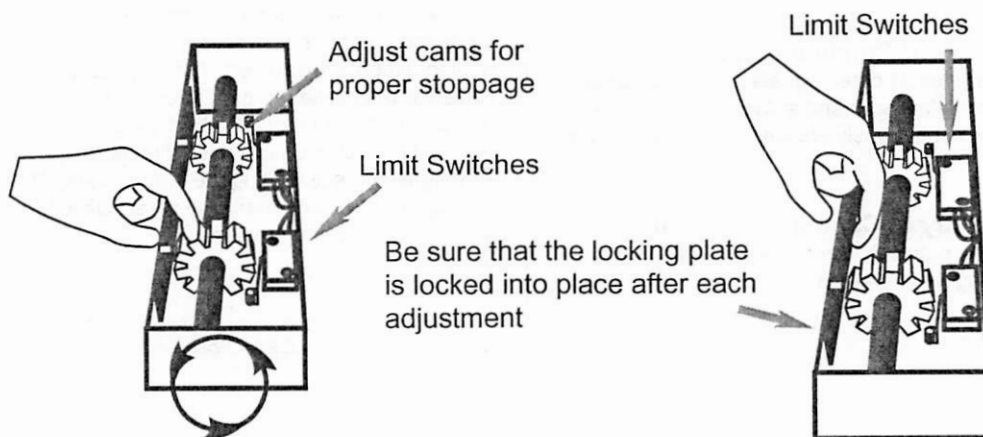

Description of Inputs

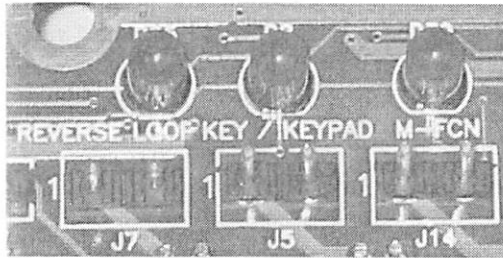

REVERSE LOOP INPUT

Reverse Loop - Momentary or Continuous Signal

This input is active only when the gate is closing or when its fully open. If this input is active, the close timer is disabled. All vehicle detectors and photo-eyes should be connected here. Multiple devices may be connected in parallel.

KEY / KEYPAD INPUT

Key / Keypad

Timer On - Momentary or Continuous Input

Once activated the gate will fully open. Activation while the gate is closing will cause the gate to reopen. Continuous activation while the gate is open will disable the timer to close function from automatically closing the gate.

Timer Off - Momentary Input

This function must be released and reentered to be recognized. This input is to be used for COMMAND OPEN / COMMAND CLOSE applications. The first signal will cause the gate to begin opening. The second signal will close the gate only when the gate is in the fully open position.

MULTI-FUNCTION INPUT

Stop - Momentary or Continuous Signal

This function overrides all other signals. Once activated, the gate will immediately stop and await a new command. If the stop input is continuously activated, the gate will not move.

Close - Momentary or Continuous Signal

Once activated the gate will fully close. Activation while the gate is opening has no effect.

Phantom Loop - Momentary or Continuous Signal

This input is active only when the gate is at rest in the fully open position. The input has no effect on the gate when fully closed or while closing or opening. Continuous activation will prevent the gate from moving in the close direction. When the input is removed normal operation is resumed. This input is intended for a vehicle loop detector to sense a vehicle in the gate path. Multiple devices may be connected in parallel.

Edge Sensor - Momentary or Continuous Signal

This signal is active when the gate is opening and/or closing.

If activated when the gate is opening:

The gate will stop, pause and reverse in the close direction for 1 1/2 seconds and stop. Continuous activation will prevent the gate from moving in the opening direction. If the second activation occurs before the limit switch is activated, the gate will stop and reverse direction for 1 1/2 seconds and stop, thus activating the alarm mode. At this point the operator must be manually reset (ON/OFF) before normal operation can resume.

If activated when the gate is closing:

The gate will stop, pause and fully reopen. During this mode the timer to close, reverse loop, exit loop and phantom loop are disabled. The Key / Keypad and Receiver will cause the gate to close if a second activation occurs before the limit switch is activated. The gate will then stop and reverse direction for 1 1/2 seconds, stop again, thus activating the alarm mode. At this point the operator must be manually reset (ON/OFF) before normal operation can resume.

Multiple devices may be connected in parallel to the Edge Sensor Input.

Connecting The Accessories

With the exception of the MAG Lock, all of these accessories can be installed on the Master or Slave operator.

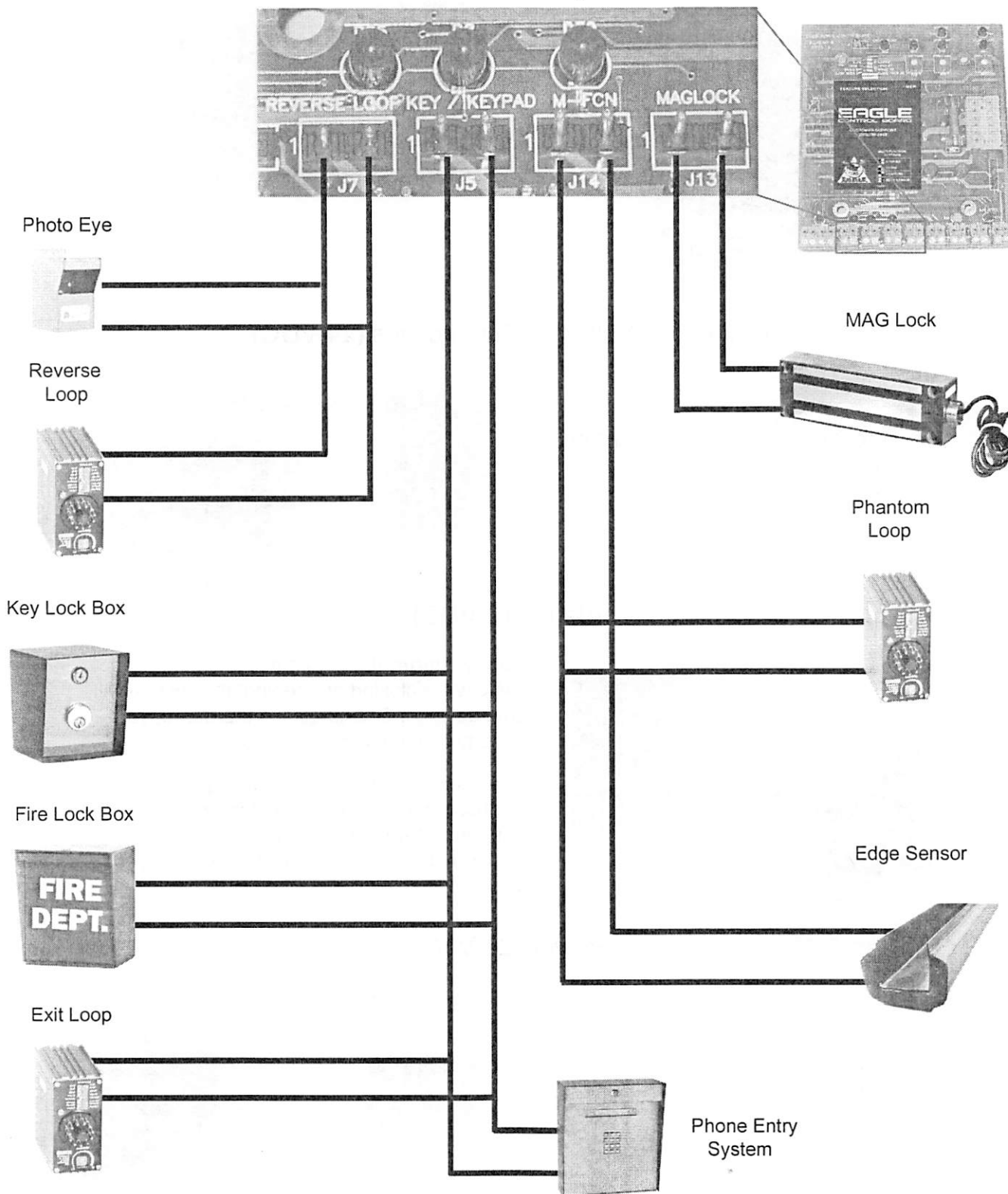

Describing The Output Connections

Entire Output Section

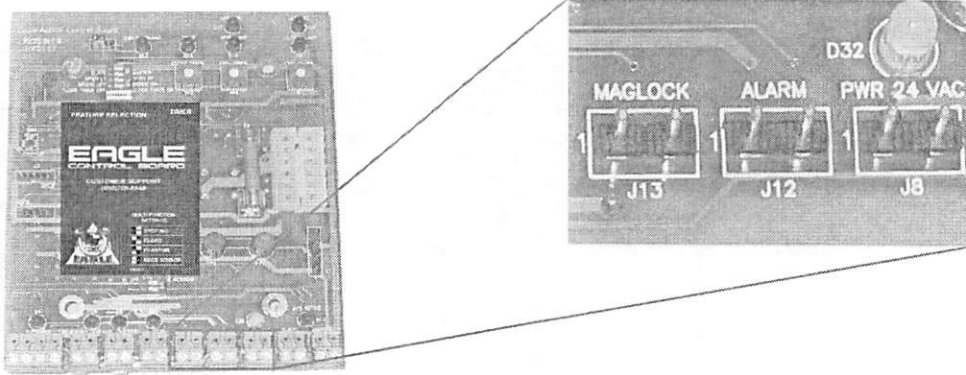

MAG Lock Solenoid Connections (24 VDC)

The Control Board provides a 24VDC and relay output for MAG Locks or Solenoids.

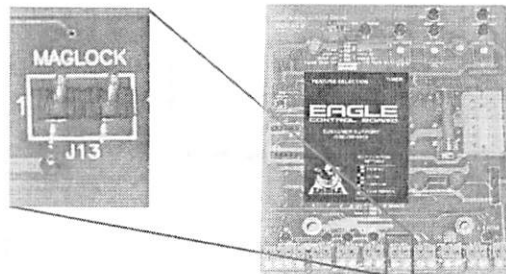

Alarm (12 VDC)

Safety Alarm: If the gate hits an obstruction twice while closing or opening, the system will shut down for 5 minutes. On the Board, you have two options of reset mode.

Selecting the "off" position will require a "manual reset" of the board if the previous happens. However, by selecting the "On" position, the system will automatically reset itself.

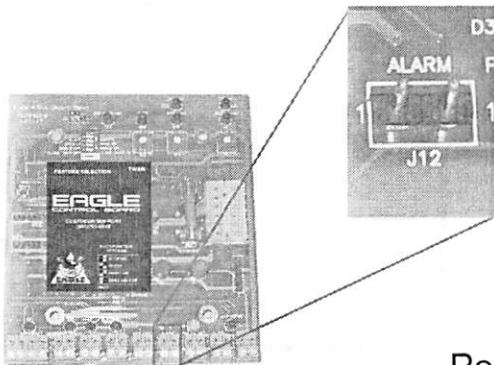

Power (24 VAC)

The Control Board provides 24 VAC Power, which can be used for loop detectors and receivers.

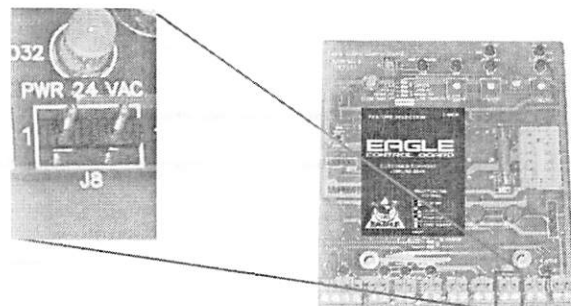

Slave Control Options

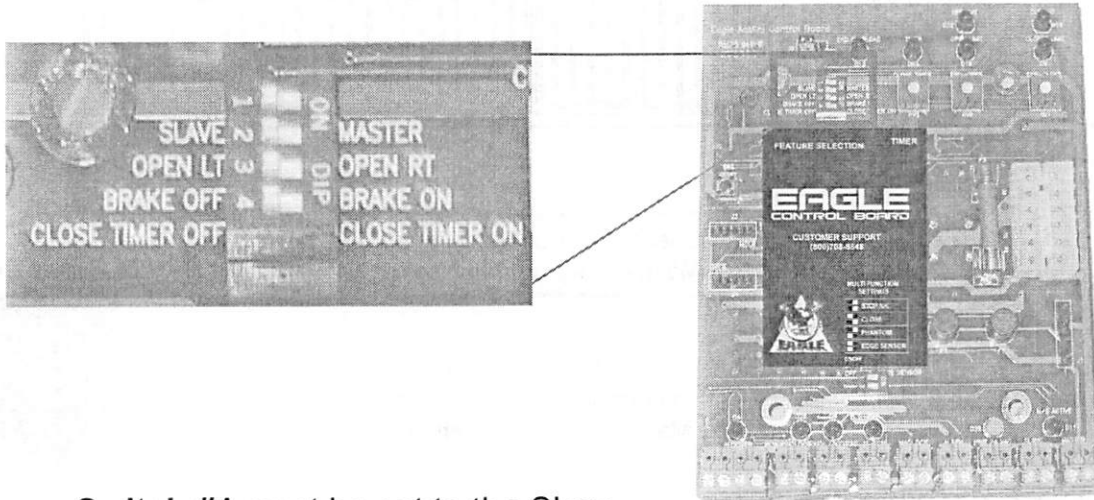

Switch #1 must be set to the Slave or to the "off" position.

Switch #2 must be set to the "open left" or to the "open right" position.

Switch #3 brake on / off.

Switch #4 Not in use.

Master and Slave Operation

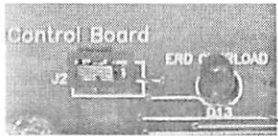

NOTE: If the Master and Slave Operators are not communicating properly, verify if they are on the same phase by switching the phase jumper on either the master or the Slave Unit.

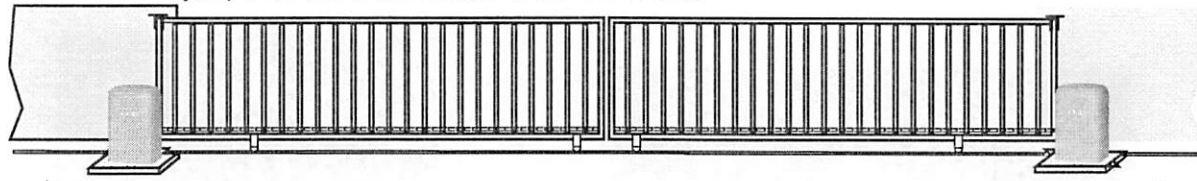

Master Board

Use 20GA stranded wire for Master/Slave communication

Slave Board

NOTE: The polarity is very important when connecting Master / Slave Operations.

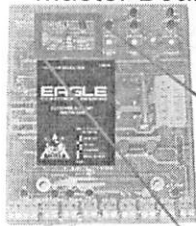

Set dip switch #1 (ON) for the Master

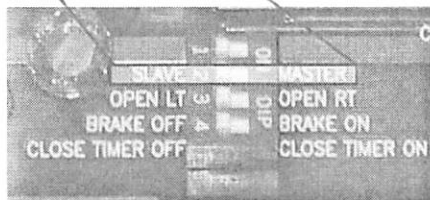

Set dip switch #1 (OFF) for the Slave

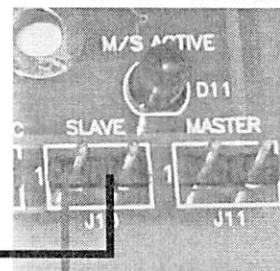
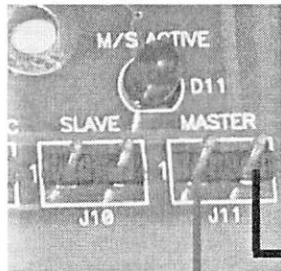
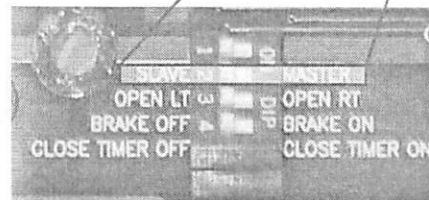

Use 20GA stranded wire

Master Control Options

Use the feature selector to choose available features by designating the various switches (1 through 4).

Gate opening direction, motor brake and close timer.

Please refer to page 10 for more information on individual switch functions.

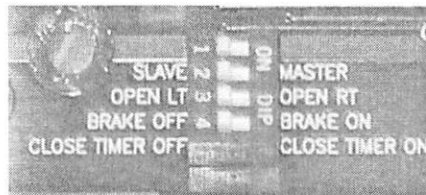

The Feature Selector

The selector uses an eight-station switch system that allows selection of the standard features and customized installation settings. The switch description is as follows:

Note: The power should always be turned off when designating feature selector switches

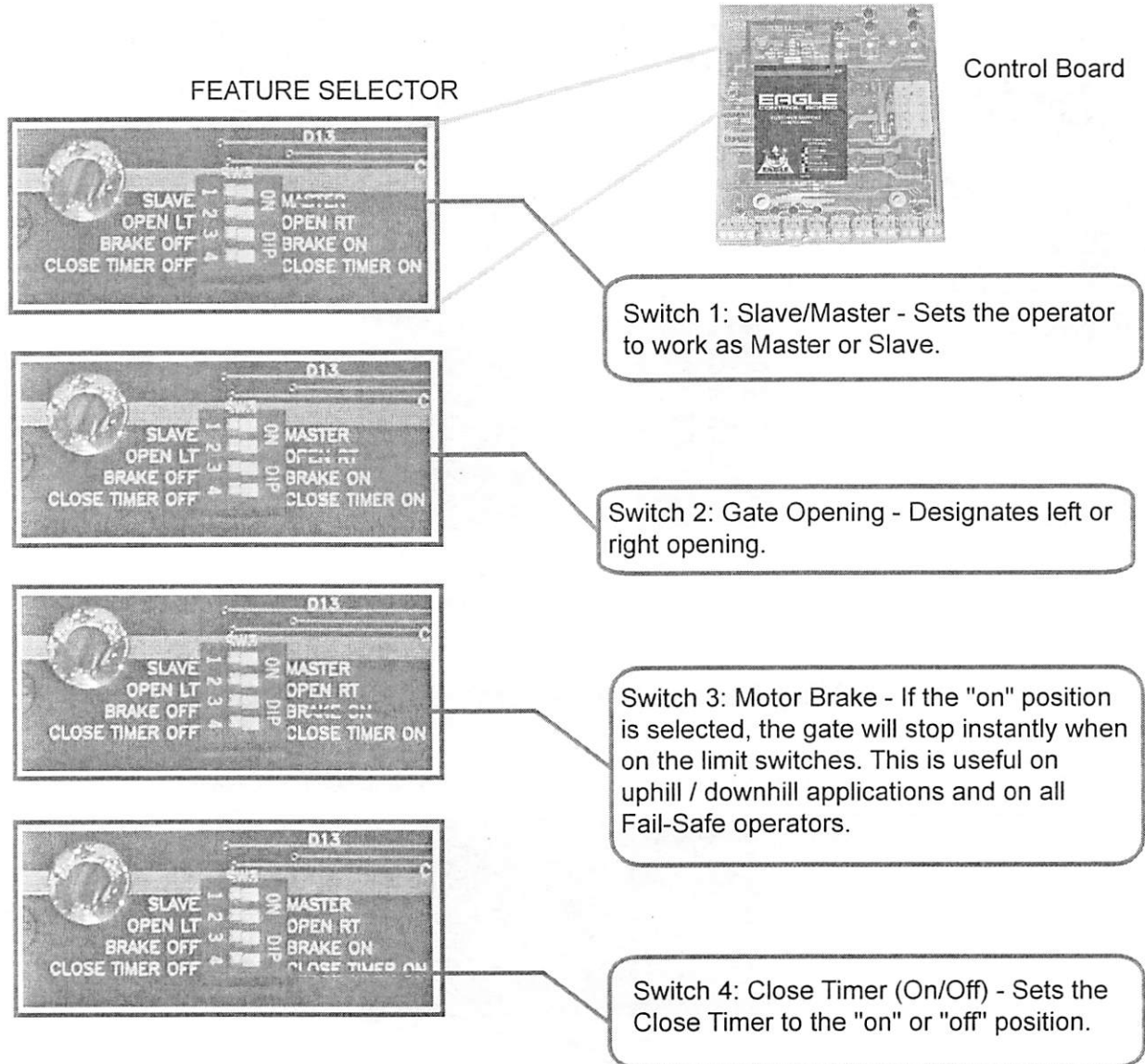

The reset button is used to reset the microprocessor. IF YOU MAKE A CHANGE WITH THE SWITCHES, YOU MUST USE THE RESET BUTTON TO APPLY CHANGES. Note: If the power light is on and the operator does not function, press the reset button once. If this does not solve the problem, proceed with turning off the power switch and then switching it back on again.



Connecting the Loop Detector

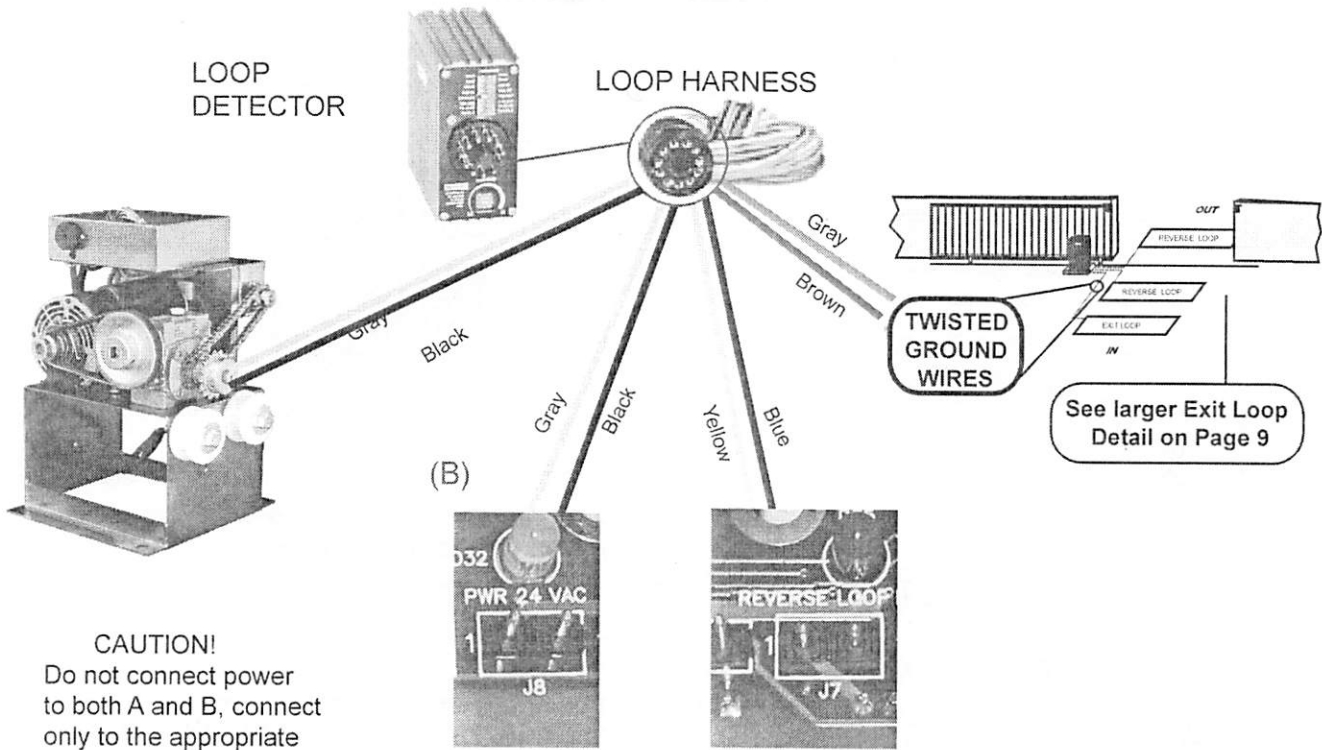

CAUTION!
Do not connect power to both A and B, connect only to the appropriate power source for your loop detector!

Loop Detector Power

For 110V power connect to the 100 junction power box (A)
For 24V AC power connect to terminal on the Diamond Board (B)

Two Way Adjustable Reverse Sensor / ERD

CAUTION! Only a qualified service technician must make all adjustments to the sensor.

There is an LED "OVERLOAD" warning that will light up when the gate is heavier than normal for the operator. During this warning, the operator will not function properly.

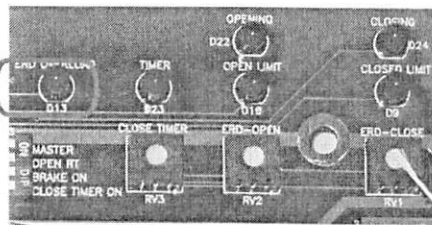

The Control Board has two separate pots for adjusting sensitivity. One is for opening the gate, and the other is for closing the gate.

IMPORTANT
The level of sensitivity depends on the weight of the gate and the conditions of installation.

When Adjusting Sensors Remember...

Too Sensitive = if the gates stops or reverses by itself

Not Sensitive enough = if the gate strikes an object and does not stop or reverse

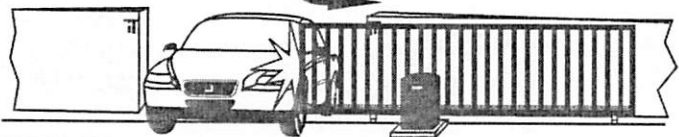

Connecting The Power



Be sure that the circuit breaker for the line input power is turned off before connecting the input power to the unit.

Connect 120 VAC, 15A, 60HZ, line input power to the wires provided in the power switch junction box located near the bottom of the operator.

Warning: Eagle Access Control Systems, Inc is not responsible for researching and complying with local building codes. Be sure to check into these codes before your installation.

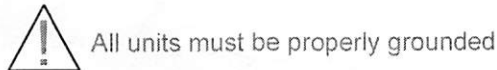
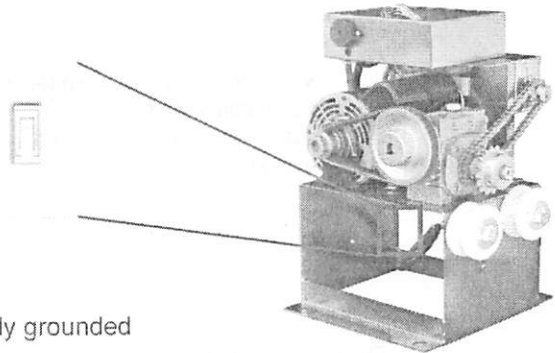

The wires are color coded as follows:

- Black - 120 VAC / Line Input Power
- White - Neutral Input
- Green - Ground Input (from an approved grounding method), the unit must be grounded

SINGLE OPERATOR	12 AWG	10 AWG	8 AWG	4 AWG
	400 ft.	650 ft.	1000 ft.	2000 ft.
DUAL OPERATORS	12 AWG	10 AWG	8 AWG	4 AWG
	200 ft.	325 ft.	500 ft.	1000 ft.

Reverse / Exit Loop Installation

The purpose of a reversing loop is to prevent the gate from closing on a vehicle while it is exiting or stopped in the middle of the gate area. The purpose of the exit loop is to automatically open the gate when a vehicle approaches to exit.

Exit Loop Operation

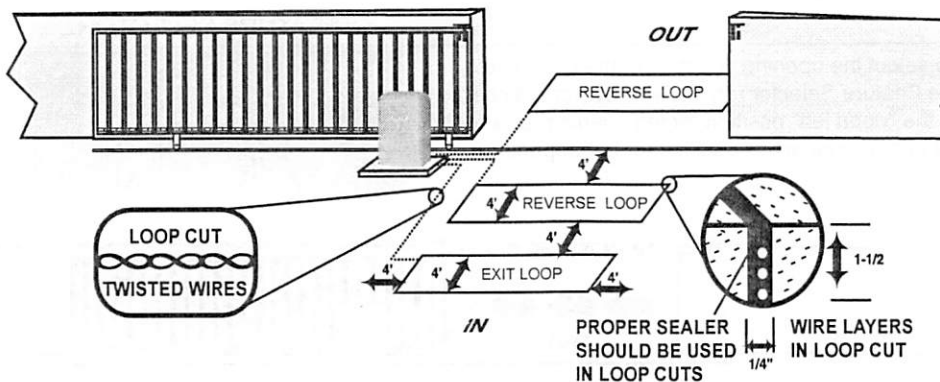

Wires must be wrapped inside the groove three times. Once you have completed the process, fill up the grooves with a proper seal.

Mounting Operator(s) To A Concrete Pad



Be sure that the operator is installed in a level and paralleled position and is properly secured. Improper installation could result in property damage, severe injury, and/or death.

Note:

The following concrete recommendations are installation suggestions only. Please consult local codes for actual requirements in your area.

Recommended Dimensions

(Concrete Pad Diagram N.T.S.)

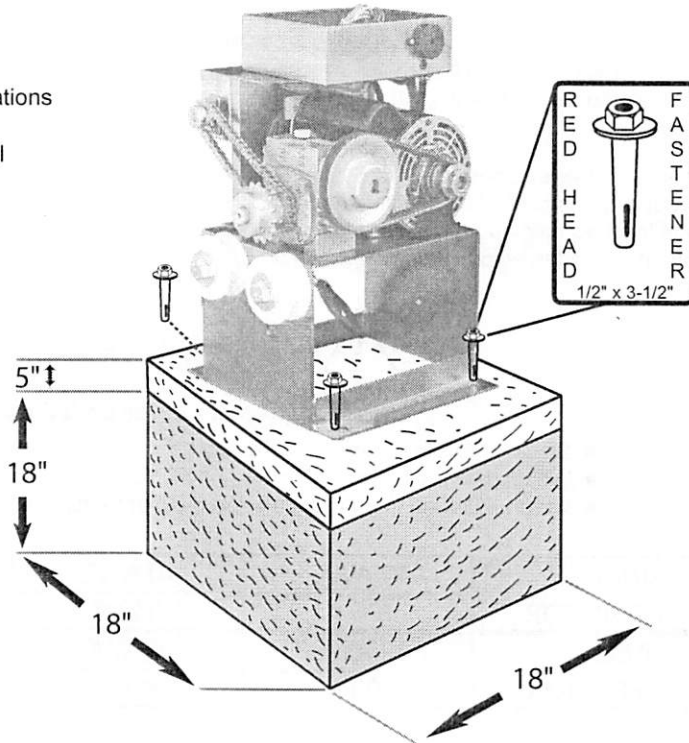

Selecting Opening Direction of Gate

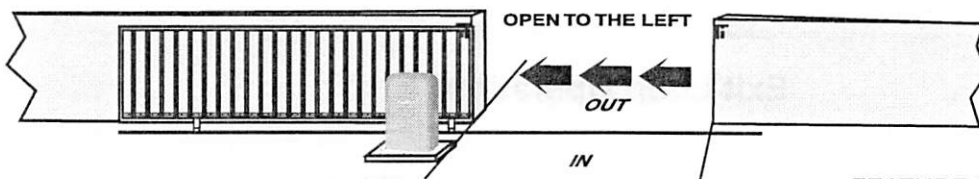

FEATURE SELECTOR

To select the opening direction of the gate, use the Feature Selector (as shown). Select switch #2 to the "open left" position for left opening. Use switch #2 to the "open right" position for right opening.

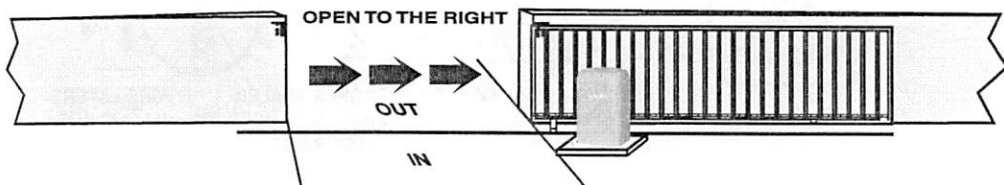
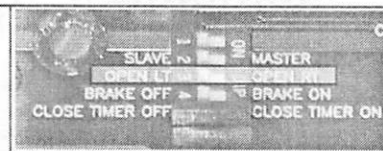

Methods of Installation



It is highly recommended to install "over travel stops" at both ends of the gate rail in any type of installation in order to prevent derailing.

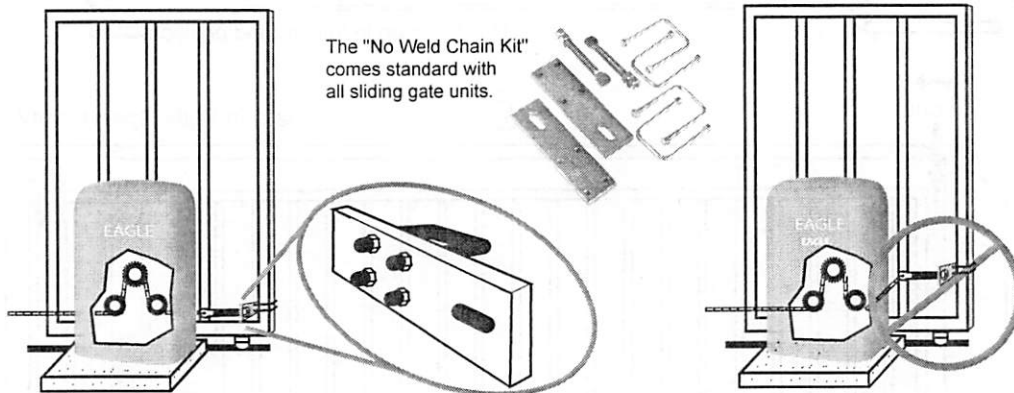
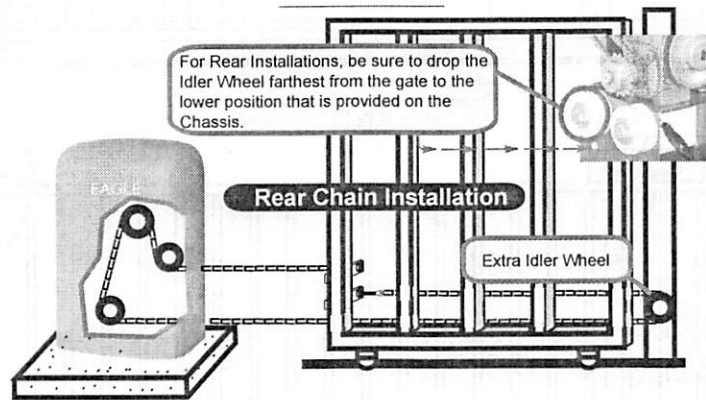
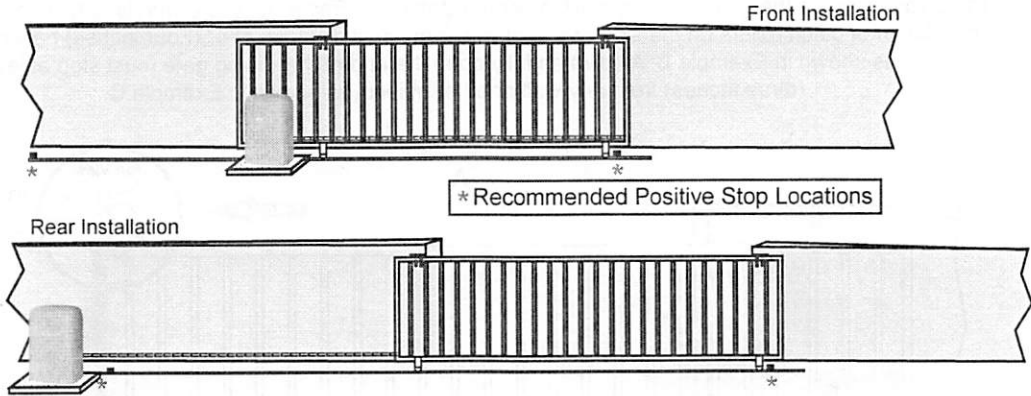

Proper Chain Installation

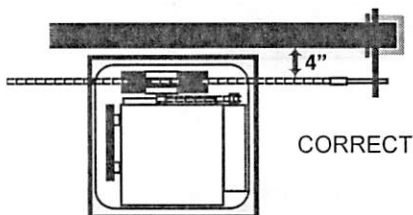

Minimum space between gate and output sprocket must be 4". After you position the gate operator, bolt-down the operator to the concrete bed. Make certain the concrete bed is solid.

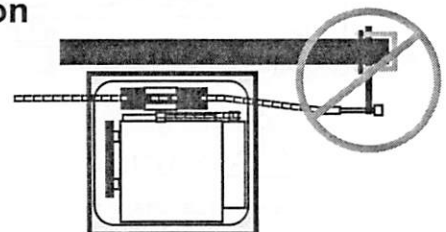

Instructions on Gate Posts

Important Notice!

Because the coasting distance may vary due to change in temperature, Eagle Access Controls does NOT recommend the installation of a stop or catch post in front of the gate path as shown in Example A. To do so will cause the gate to hit the post in certain instances. Eagle Access Controls only recommends installation of catch rollers on the side of a post with a minimal distance of 4" (Four inches) between the rollers as shown in Example B. Also when fully open the end of the sliding gate must stop at least 3" (three inches) from any wall or other objects as shown in Example C.

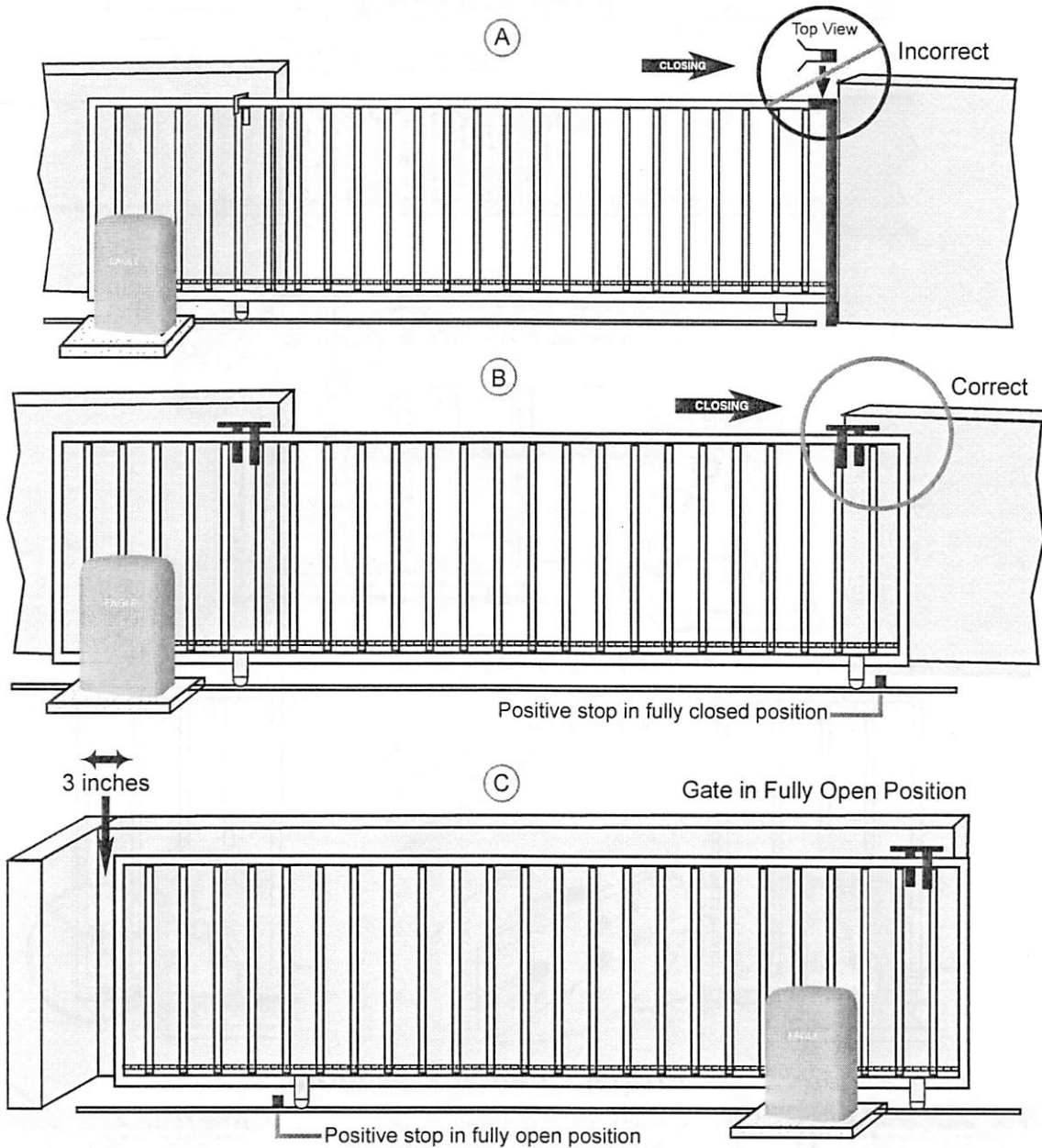

CAUTION!

Regarding Positive Stops

For safety reasons, a positive stop must be installed on the gate track prior to installation of the gate. This will assure that the gate does not exceed movement limit and derail while opening or closing fully.

Installing the Warning Sign

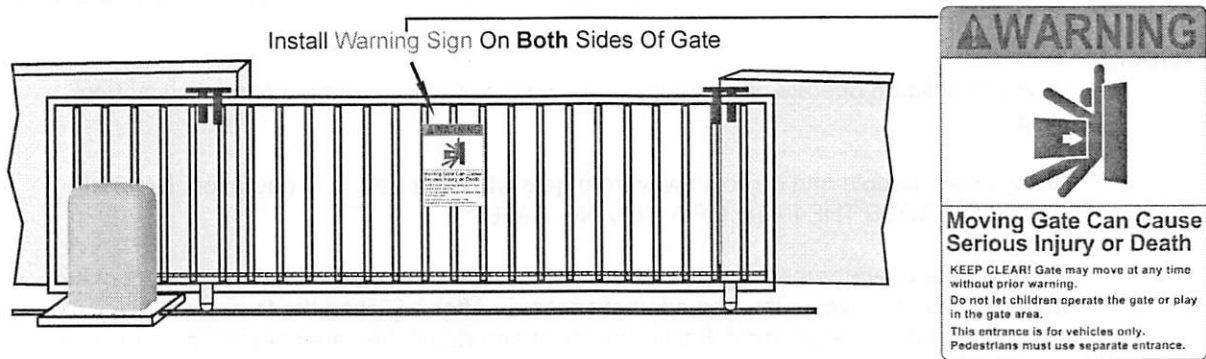

Precautions



Be sure to mount ALL operating devices clearly out of reach of through gate.

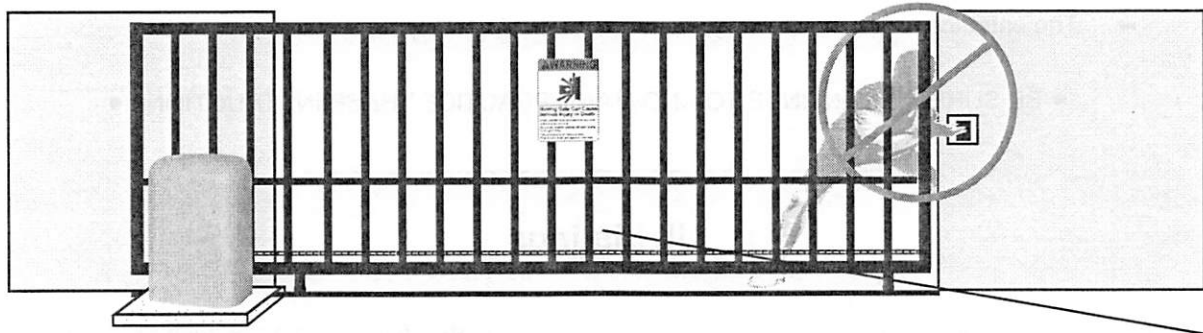

Regarding Ornamental Grill Styled Gates:

Injuries may be avoided if a mesh or screen is installed on the gate. Injuries resulting from hands and feet becoming stuck in gate or children riding the gate while in movement, can be greatly reduced if this "screen" or "mesh" is applied to gate as a safety precaution.

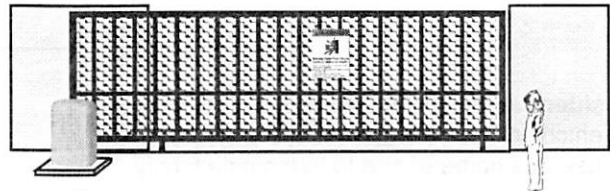

CAUTION!



Be sure to read and follow all the Eagle Access Control Systems, Inc. and UL instructions before installing and operating any Eagle Access Control Systems, Inc. products. Eagle Access Control Systems, Inc. is not responsible for any improper installation procedures caused by installer or user failing to comply with local building codes.

UL Listings

Essential Safety Procedures

WARNING - TO REDUCE THE RISK OF INJURY OR DEATH - READ AND FOLLOW ALL INSTRUCTIONS:

- Never let children operate or play with gate controls. Keep the remote control away from children.
 - Always keep people and objects away from gate while the gate is in operation. NO ONE SHOULD CROSS THE PATH OF A MOVING GATE.
 - Test the gate operator monthly. The gate must reverse on contact with a rigid object or stop when an object activates the non-contact sensors. After adjusting the force or the limit of travel, retest the gate operator. Failure to adjust and retest the gate operator properly can increase the risk of injury or death.
 - Use the emergency release only when the gate is not moving. Make sure the power for the gate operator is off.
 - KEEP GATES PROPERLY MAINTAINED. Read and follow the manual. Have a qualified service person make repairs to the gate or gate hardware.
 - The entrance is for vehicles only. Pedestrians must use separate entrance.
- BE SURE TO CONTINUE TO KNOW AND PRACTICE THESE INSTRUCTIONS •

UL Listings

Vehicular horizontal slide-gate operator (or system) - A vehicular gate operator (or system) that controls a gate which slides in a horizontal direction that is intended for use for vehicular entrance or exit to a drive, parking lot, or the like.

Gate - A moving barrier such as a swinging, sliding, raising, lowering, rolling, or like barrier that is a stand-alone passage barrier or is that portion of a wall or fence system that controls entrance and/or egress by persons or vehicles and completes the perimeter of a defined area.

Residential vehicular gate operator - Class I - A vehicular gate operator (or system) intended for use in a home of one to four single family dwellings, or a garage or parking area associated therewith.

Commercial / General access vehicular gate operator - Class III - A vehicular gate operator (or system) intended for use in an industrial location, loading dock area, or other location not intended to service the general public.

Commercial / General access vehicular gate operator - Class II - A vehicular gate operator (or system) intended for use in a commercial location or building such as a multi-family housing unit (five or more single family units), hotel, garages, retail store, or other buildings servicing the general public.

Commercial / General access vehicular gate operator - Class IV - A vehicular gate operator (or system) intended for use in a guarded industrial location or buildings such as airport security area or other restricted access locations not servicing the general public, in which unauthorized access is prevented via supervision by security personnel.

UL Listings

Gate Operators Installation Instructions

- 1) Install the gate operator only when:
 - The operator is appropriate for the construction and the usage Class of the gate.
 - All openings of a horizontal slide gate are guarded or screened from the bottom of the gate to a minimum of 4 feet (1.2 m) above the ground to prevent a 2 ¼ inch (57.15 mm) diameter sphere from passing through the openings anywhere in the gate, and in that portion of the adjacent fence that the gate covers in the open position.
 - All exposed pinch points are eliminated or guarded.
 - Guarding is supplied for exposed rollers.
- 2) The operator is intended for installation only on gates used for vehicles. Pedestrians must be supplied with a separate access opening.
- 3) The gate must be installed in a location so that enough clearance is supplied between the gate and adjacent structures when opening and closing to reduce the risk of entrapment. Swinging gates shall not open into public access areas.
- 4) The gate must be properly installed and work freely in both directions prior to the installation of the gate operator.
- 5) Controls must be far enough from the gate so that the user is prevented from coming in contact with the gate while operating the controls. Controls intended to be used to reset an operator after two sequential activations of the entrapment protection device(s) must be located in the line of sight of the outdoor gate or easily accessible controls shall have a security feature to prevent unauthorized use.
- 6) All warning signs and placards must be installed where visible in the area of the gate.
- 7) For a gate operator utilizing a non-contact sensor such as a photo beam:
 - See instructions on the placement of non-contact sensor for each type of application.
 - Care shall be given to reduce the risk of nuisance tripping such as when a vehicle trips the sensor while the gate is still moving.
 - One or more non-contact sensors shall be located where the risk of entrapment or obstruction exists, such as the perimeter reachable by a moving gate or barrier.
- 8) Gate operators utilizing a contact sensor such as an edge sensor:
 - One or more contact sensors shall be located at the leading edge, trailing edge, and post mounted both inside and outside of a vehicular horizontal sliding gate.
 - One or more contact sensors shall be located at the bottom edge of a vehicular lift gate.
 - One or more contact sensors shall be located at the pinch point of a vehicular vertical pivot gate.
 - A hard wire contact sensor shall be located and its wiring arranged so that the communication between the sensor and the gate operator is not subject to mechanical damage.
 - A wireless contact sensor such as one that transmits radio frequency (RF) signals to the gate operator for entrapment protection functions shall be located where the transmission of the signals are not obstructed or impeded by building structure, natural landscaping, or similar obstruction. A wireless contact sensor shall function under the intended end use conditions.

Table of Contents

Contents	Page
UL Listings	Page 3/4
Installing the Warning Sign / Precautions	Page 5
Instructions on Gate Posts	Page 6
Positive Stops	Page 6
Methods of Installation	Page 7
Proper Chain Installation	Page 7
Mounting Operator(s) to Concrete Pad(s)	Page 8
Selecting the Opening Direction of Gate	Page 8
Connecting the Power	Page 9
Reverse / Exit Loop Installations	Page 9
Two Way Adjustable Reverse Sensors / ERD	Page 10
The Feature Selector	Page 11/12
Master and Slave Operation	Page 13
Master Control	Page 13
Slave Control	Page 14
Selecting the Delay Functions	Page 14
Describing the Output Connections	Page 15
MAG Lock Solenoid	Page 15
Alarm	Page 15
24 VAC Auxiliary Power	Page 15
Connecting the Accessories	Page 16
Description of Inputs	Page 17
Receiver Connections	Page 18
Gate Travel Distance / Setting the Limit Switches	Page 18
Emergency Releases	Page 18

© 2002 Eagle Access Control Systems, Inc.

All rights reserved. No part of this manual may be reproduced in any means: graphics, electronics, or mechanical, including photocopying without the expressed written permission of the publisher. Materials, components and specifications are subject to change without notice.



EAGLE-1

SLIDE GATE OPERATOR

Gate Capacity 18' & 300 lbs

INSTRUCTION MANUAL



MADE IN USA

ADVANCED FEATURES

5 YEAR WARRANTY

QUIET OPERATION