



KONTROL "large"



KONTROL "small"



EVE actuators



EVO actuators



HC actuators

SW actuators



Watch our video installation guides on ducati's [Youtube Channel](#)



Swing gate openers Installation manual



REV 19 10-10-18 ENG



ducatihome.it

DUCATI INDEX how to easily consult this guide

How to read this general manual

This manual contains the general instructions for all HC, SW, EVO and EVE gate openers and is divided into three general sections.

- Mechanical installation of the motors.
- Installation of the control box, wiring and control board adjustments
- Accessories instructions.

Identify your actuator model and your electronic board model through the labels that you'll find on your control box and actuator or by consulting the kit contents table on page 4-5 and follow the specific instructions

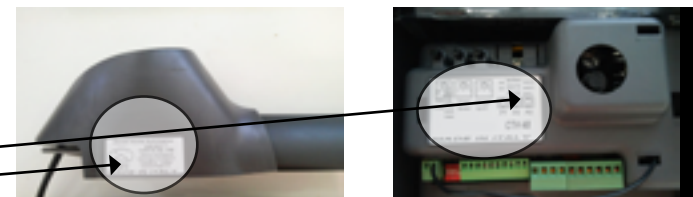

Electromechanical actuators for swing gates	Page
Kit composition Table	4-5
Actuator comparison table: shows technical features, and usage limits	6
Electronic board comparison Table:	7
General Instalaltion diagram, Stop limits and how to determinate A & B measures for a correct installation	8-9
HC 312 actuator's installation diagram and limits	10
HC 412 actuator's installation diagram and limits	11
HC 512 actuator's installation diagram and limits	12
HC 612 actuator's installation diagram and limits	13
HC 418 actuator's installation diagram and limits	14
HC 518 actuator's installation diagram and limits	15
HC 618 actuator's installation diagram and limits	16
SW 400 actuator's installation diagram and limits	17
SW 400T actuator's installation diagram and limits	18
EVO 700 actuator's installation diagram and limits	19
EVO 700T actuator's installation diagram and limits	20
EVE 900 actuator's installation diagram and limits	21
EVE 900T actuator's installation diagram and limits	22
EVE line actuators: specific drawings	23
HC line actuators: specific drawings	24
SW & EVO line actuators: specific drawings	25
How to install the actuators	26-31
1- General characteristics	26
2- Security precautions measures	26-27
3- Installation of the actuator's mounting brackets	28
4- General installation plan and important information	28
5- Emergency manual release	30
6- Test of correct mechanical installation	30
7- End limits fixed on the ground / mechanical integrated limits	30
8-9 Safety, testing and maintenance	31

Control boxes	Page
Control box "kontrol small" & " kontrol large"	33
Main power supply 230V / 110V	34
Electronic board CTH41 & CTH41MONO	35-37
CTH42	38-42
CTH44	43-47
CTH48 & CTH48/24V	48-55
Accessories	Page
Rolling code remote controls 6203R 6203P;6204,6202,6208	56
Radio keypad	57-58
Light blinkers a& external Antennas	59
External additional Radio-receiver RIXY 6040	60
External additional Radio-receiver RIXY 6043	61
Key switches and wired commands	62
Photocells (infrared safety beam)	63-66
Photocells (infrared safety beam)	64-65
Solar panels with consumption table	67-68
Accessories list table	69-71
HC actuator's Spare parts list table	72-74
SW & EVO actuator's Spare parts list table	75-76
EVE actuator's spare part list	77
Control box spare part list	78
Safety, Ce conformity and EU norms	79
Warranty and after sale service	80
System correct working Test	81
FAQ: Easy trouble shooting	82-83











www.ducatihome.it
Sign in now !

click on following page link:

<https://www.ducatihome.it/account/register>

Open your personal account to activate the warranty and assistance
Only by registering you will be rewarded discounts and special offers
You will always be kept up to date with preferential treatment

DUCATI Composition of the basic gate opener kits

Kit contents													
	HC418 (400mm)	HC518 (500mm)	HC618 (600mm)	HC312 (300mm)	HC412 (400mm)	HC512 (400mm)	HC612 (600mm)	SW400	SW400T	EVO700	EVO700T	EVE900	EVE 900T
HC 819	2x(12V)			-	-	-	-	-	-	-	-	-	-
HC 812-300	-	-	-	2x (12V)	-	-	-	-	-	-	-	-	-
HC 812-400	-	-	-	-	2x (12V)	-	-	-	-	-	-	-	-
HC 812-300 SOLAR	-	-	-	2x (12V)	-	-	-	-	-	-	-	-	-
HC 812-400 SOLAR	-	-	-	-	2x (12V)	-	-	-	-	-	-	-	-
HC 812-400 PRO	-	-	-	-	2x(12 o 24V)	-	-	-	-	-	-	-	-
HC 812-500 PRO	-	-	-	-	-	2x(12 or 24V)	-	-	-	-	-	-	-
HC 812-600 PRO	-	-	-	-	-	-	2x(12 or 24V)	-	-	-	-	-	-
HC 619 PRO	-	-	2x (12 o 24V)	-	-	-	-	-	-	-	-	-	-
SW 3000	-	-	-	-	-	-	-	2x (12V)	-	-	-	-	-
SW 7000	-	-	-	-	-	-	-	2x (12V)	-	-	-	-	-
SW 7000 T	-	-	-	-	-	-	-	-	2x (12V)	-	-	-	-
SW 7000 T SOLAR	-	-	-	-	-	-	-	-	2x (12V)	-	-	-	-
EVO 748	-	-	-	-	-	-	-	-	-	2x (12 or 24V)	-	-	-
EVO 748 T	-	-	-	-	-	-	-	-	-	-	2x (12 or 24V)	-	-
EVO 748 SOLAR	-	-	-	-	-	-	-	-	-	2x (12V)	-	-	-
EVO 748 T SOLAR	-	-	-	-	-	-	-	-	-	-	2x (12V)	-	-
EVE 948T	-	-	-	-	-	-	-	-	-	-	-	-	2x (12 or 24V)
EVE 948 T SOLAR	-	-	-	-	-	-	-	-	-	-	-	-	2x (12V)
EVE 948 T PRO	-	-	-	-	-	-	-	-	-	-	-	-	2x (12 or 24V)
EVE 948 T PRO SOLAR	-	-	-	-	-	-	-	-	-	-	-	-	2x (12 or 24V)

Note: Versions “MONO” have the same kit composition of the corresponding kit model shown in the above table, but with only one actuator instead of two.

Attention: Some kit compositions not listed in this table may be available. Check the exact composition of your kit as stated in your order confirmation.

1x	-	-	-	-	1 x	1x	2x	1x	-	-	-	1x	-	-	-	-
-	1x	-	-	-	1 x	1x	2x	1x	-	-	-	1x	-	-	-	-
-	1x	-	-	-	1 x	1x	2x	1x	-	-	-	1x	-	-	1x	-
-	-	1x	-	-	1 x	1x	2x	1x	-	-	-	1x	1x	1x	-	-
-	-	1x	-	-	1 x	1x	2x	1x	-	-	-	1x	1x	1x	1x	-
-	-	-	-	-	1 x	1x	2x	1x	-	-	-	1x	-	-	1x	-
-	-	-	1x (12 or 24V)	-	1 x	1x	2x	1x	-	-	-	1x	-	-	1x	-
-	-	-	1x (12 or 24V)	-	1 x	1x	2x	1x	-	-	-	1x	-	-	1x	-
-	-	-	1x (12 or 24V)	-	1 x	1x	2x	1x	-	-	-	1x	-	-	1x	-
1x	-	-	-	-	1 x	1x	2x	1x	-	-	1x	-	-	-	-	-
-	1x	-	-	-	1 x	1x	2x	1x	-	-	1x	-	-	-	-	-
-	1x	-	-	-	1 x	1x	2x	1x	-	-	1x	-	-	-	-	-
-	-	1x	-	-	1 x	1x	2x	-	-	-	1x	-	1x	1x	-	-
-	-	-	1x (12 or 24V)	-	1 x	1x	2x	-	-	-	1x	-	-	-	-	1x
-	-	-	1x (12 or 24V)	-	1 x	1x	2x	-	-	1x	1x	-	-	-	-	1x
-	-	-	1x (12 V)	-	1 x	1x	2x	-	-	1x	1x	-	1x12V 10W	1x12V 7A	-	1x
-	-	-	1x (12V)	-	1 x	1x	2x	-	-	1x	1x	-	1x12V 10W	1x12V 7A	-	1x
-	-	-	1x (12 or 24V)	-	1 x	1x	2x	-	-	1x	1x	-	-	-	-	1x
-	-	-	1x (12)	-	1 x	1x	2x	-	-	1x	1x	-	1x12V 10W	1x12V 7A	-	1x
-	-	-	-	1x (12 or 24V)	1 x	1x	2x	-	-	-	1x	-	-	-	-	1x
-	-	-	-	1x (12 or 24V)	1 x	1x	2x	-	-	-	1x	-	1x12V 10W (24V 20W)	1x12V 7A (2x12V 5A)	-	1x

* = the component model included in the kit can be selected at the discretion of the manufacturer

DUCATI actuator's technical data comparison

actuator model	see page	power supply	W	N	stroke (mm)	speed (cm/sec)	telescopic tube	ideal for continuous use	working temperature	on board mechanical limit for closed position (pull to open)	on board mechanical limit for open position (pull to open)	on board electric limit for closed & open position	Max. wing lenght (L)	Max wing weight	Max. opening angle	Manual release system	Compatible with key protected manual release optional accessory	Automatic wing lock
HC 312	10	12V	60W	1200	300	1,5	√	√	-20°C/+60°C	-	FC version only	-	2,5m	250 kg	125°	√	-	√
HC 312/ 24 V	10	24V	120W	2400	300	2	√	√	-20°C/+60°C	-	FC version only	-	2,5m	350 kg	125°	√	-	√
HC 412	11	12V	60W	1200	400	1,5	√	√	-20°C/+60°C	-	FC version only	-	3,5m	350 kg	137°	√	-	√
HC 412 / 24V	11	24V	120W	2400	400	2	√	√	-20°C/+60°C	-	FC version only	-	3,5m	450 kg	137°	√	-	√
HC 512	12	12V	60W	1200	500	1,5	√	√	-20°C/+60°C	-	FC version only	-	4m	400 kg	137°	√	-	√
HC 512 / 24V	12	24V	120W	2400	500	2	√	√	-20°C/+60°C	-	FC version only	-	4m	500 kg	137°	√	-	√
HC 612	13	12V	60W	1200	600	1,5	√	√	-20°C/+60°C	-	FC version only	-	5m	400 kg	137°	√	-	√
HC 612/ 24V	13	24V	120W	2400	600	2	√	√	-20°C/+60°C	-	FC version only	-	5m	500 kg	137°	√	-	√
HC 418	14	12V	60W	1200	400	1,5	-	√	-20°C/+60°C	FC version only	FC version only	-	2m	200 kg	120°	√	-	√
HC 418 /24V	14	24V	120W	2400	400	2	-	√	-20°C/+60°C	FC version only	FC version only	-	2m	300 kg	120°	√	-	√
HC 518	15	12V	60W	1200	500	1,5	-	√	-20°C/+60°C	FC version only	FC version only	-	3m	350 kg	125°	√	-	√
HC518 /24V		24V	120W	2400	500	2	-	√	-20°C/+60°C	FC version only	FC version only	-	3m	450 kg	125°	√	-	√
HC 618	16	12V	60W	1200	600	1,5	-	√	-20°C/+60°C	-FC version only	FC version only	-	4m	350kg	130°	√	-	√
HC618 / 24V	16	24V	120W	2400	600	2	-	√	-20°C/+60°C	FC version only	FC version only	-	4m	450kg	130°	√	-	√
SW400	17	12V	60W	1200	400	1,5	-	√	-20°C/+60°C	FC version only	FC version only	-	2m	200 kg	120°	√	SW LOCK	√
SW400 / 24V	17	24V	120W	2400	400	2	-	√	-20°C/+60°C	FC version only	FC version only	-	2m	300 kg	120°	√	SW LOCK	√
SW400 T	18	12V	60W	1200	400	1,5	√	√	-20°C/+60°C	-	FC version only	-	2,6m	260 kg	135°	√	SW LOCK	√
SW400 T /24V	18	24V	120W	2400	400	2	√	√	-20°C/+60°C	-	FC version only	-	2,6m	360 kg	135°	√	SW LOCK	√
EVO 700	19	12V	60W	1200	500	1,5	-	√	-20°C/+60°C	FC version only	FC version only	-	4m	350 kg	140°	√	SW LOCK	√
EVO 700 /24V	19	24V	120W	2400	500	2	-	√	-20°C/+60°C	FC version only	FC version only	√	4m	450 kg	140°	√	SW LOCK	√
EVO 700T	20	12V	60W	1200	500	1,5	√	√	-20°C/+60°C	-	FC version only	-	5m	350 kg	135°	√	SW LOCK	√
EVO 700T /24V	20	24V	120W	2400	500	2	√	√	-20°C/+60°C	-	FC version only	√	5m	450 kg	135°	√	SW LOCK	√
EVE 900	21	12V	60W	1200	500	1,5	-	√	-20°C/+60°C	√	√	FCA version only	4m	450 kg	130°	√	EVE LOCK	√
EVE 900 /24V	21	24V	120W	2400	500	2	-	√	-20°C/+60°C	√	√	FCA version only	4m	550 kg	130°	√	EVE LOCK	√
EVE 900 T	22	12V	60W	1200	500	1,5	√	√	-20°C/+60°C	√	√	FCA version only	5m	400 kg	135°	√	EVE LOCK	√
EVE 900 T /24V	22	24V	120W	2400	500	2	√	√	-20°C/+60°C	√	√	FCA version only	5m	500 kg	135°	√	EVE LOCK	√

Electronic board comparison table	CTH41 supplied in control box model KONTROL 7851	CTH41MONO supplied in control box model KONTROL 7851 MONO	CTH42 supplied in control box model KONTROL 7855	CTH44 supplied in control box model KONTROL 7857	CTH48 supplied in control box model KONTROL 9048
Use	2 wings gates	1 wing gates	1 or 2 wing gate	1 or 2 wing gate	1 or 2 wing gate
System operating voltage	12V (from transformer)	12V (from transformer)	12V (from transformer)	12V (from Solarpanel + battery or from transformer with backup battery)	12V (from Solarpanel + battery or from transformer or from backup battery)
Compatible with emergency batteries in case of power failure	-	-	Yes, with additional CMBAT battery charger module	Yes, battery and solar panel management ready on board	Yes, 12v Directly or 24V for standard 2 speed duse with additional CMBAT battery charger module
Compatible with Solar apnel power supply	-	-	Yes, with additional CMBAT battery charger module	JA ist bereits auf der Platine vorgesehen: direkte Anbindung an das Solarmodul 12V	Yes, with additional 2x CMBAT battery charger module
Stand-By consumption	0,008A	0,008A	0,012A	0,007A	0,007A
Step by step working mode	√	√	√	√	√
Automatic closure working mode	Yes. fix pause time 30 sec.	√. fix pause time 30sec.	√ with adjustaple pause time up to 100 sec.	√ with adjustaple pause time up to 100 sec.	√ with adjustaple pause time up to 100 sec.
Obstacle detection system in compliance with EN 13241-12453	√	√	√	√	√
In case of obstacle detection	gate stops	gate stops	gate stops	gate stops	gate reverse
Motor power adjustment	-	-	√	√	√
Pedestrian opening (1 wing partially opens)	-	-	√ from remote control or wired keyswitch	√ from remote control	√ from remote control or wired keyswitch
SOFT STOP	-	-	-	-	Yes
Electric-lock compatibility	-	-	√ output 12V ac but if powered by battery only electolock with booster	-	√ output 12V dc requires electolock with booster
phase shift displacement time actuators adjustment	-	-	-	-	√
Courtesy light output	-	-	√ timerized	-	√ timerized
Rolling code radio-receiver	1-channel	1-channel	2-channels	2-channels	2-channels
Input for photocells,key switch, blinker	√	√	√	√	√
Input aerial antenna	-	-	√	√	√

DUCATI General installation diagram

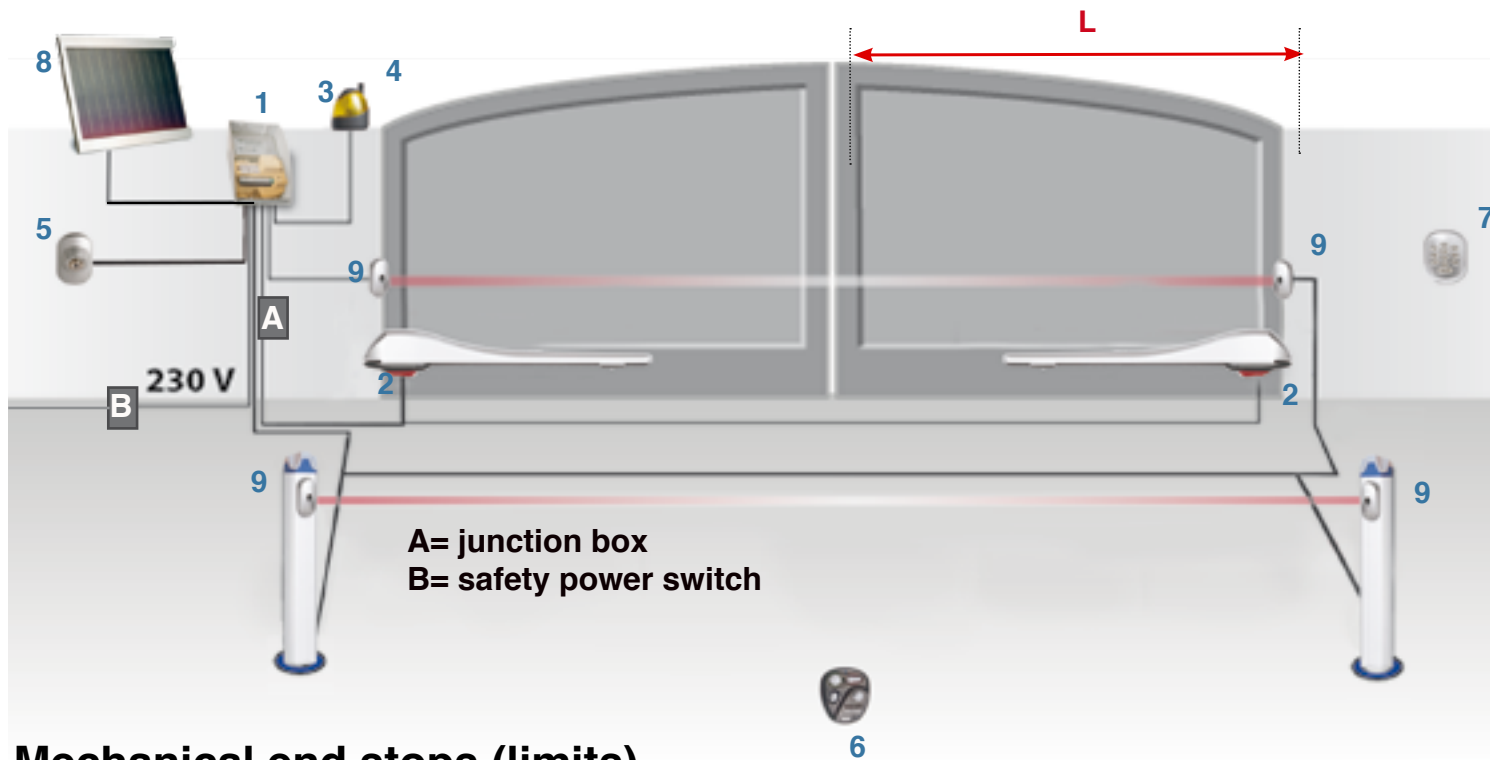

- 1= Control box with containing electronic board with on board radio receiver, toroidal transformer, integrated battery housing compartment.
- 2 = actuators
- 3 = blinking light
- 4 = external antenna (if supplied)
- 5 = key switch
- 6 = radio remote control
- 7 = radio keypad (if supplied)
- 8 = solar panel (if supplied)
- 9 = pair of photocells (if supplied)
- L= wing lenght

A= junction box
B= safety power switch

WARNING: angle of incidence

To ensure a perfect lock of the gate when closed, the actuator must be installed in way to have an angle of incidence to the gate wing in closed position. a greater angle ensu- res greater tightness

Mechanical end stops (limits)

It is mandatory that your gate has mechanical limits fixed on the ground. The limits must stop the gate wings in the closed and open position of each wing. Your gate must be provided with mechanical end stops to be automated. The end sops on the floor can only be omitted in case of gate opener supplied with integrated limits (FC versions). Ducati's gate openers are conceived to stop by amperometric detection. When the gate wing touches and pushes on the mechanical limit (end stop), an amperometric increase is detected by the control board and motor stops. An imperceptible drive reversal draws pressure from the gears of the engine to preserve its life

Warning: make sure not to use the full actuator stroke as the gate wing must stop by pressing on a mechanical end limit (fixed on the ground or FC onboard limit) before the actuator reaches the end of it's stroke.

Warning: if you purchased an FC version actuator, check whether the integrated limit can be used for the open or closed gate position: in fact, not all FC-actuators have double end travel for both positions gate open + gate closed. The use of the integrated travel limit also depends on the opening direction of the gate (push-to-open or pull-to-open).

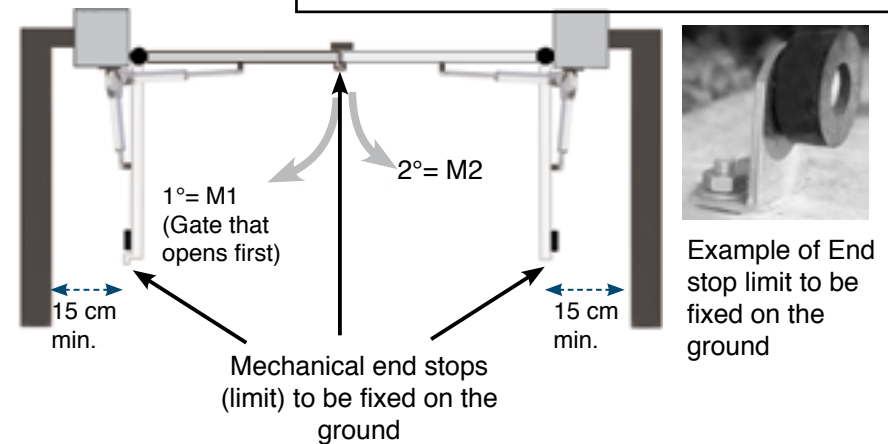

PULL TO OPEN OPERATION (gate that opens towards inside)

This means the gate operator is mounted on the inside of the property and pulls your gate in towards the property to open.

Warning: Each actuator model has limits to the use of measurements A and B. Therefore, verify the conformance of the actuator model with the size of your structure (see following pages the measurement limits A and B for each actuator model). The greater the distance between the gate hinge and the inner edge of the pillar, the longer the chosen actuator will be. It is recommended to install actuators with a certain incidence angle over the gate (not too parallel to the gate itself) for better mechanical performance.

A and B measure the distance between the gate hinge and the rotation center of the actuator (respectively on longitudinal axis and transversal axis). These measurements determine the maximum opening gate and opening speed of the gate. Check the A & B limits for each actuator model in the following pages.

CAUTION: It is recommended not to use the entire stroke of the drive and to install actuators with a certain incidence angle over the gate.

CAUTION: The gate opening speed depends on the length of the actuator's run used. The less run (stroke) you use, the faster the gate will open.

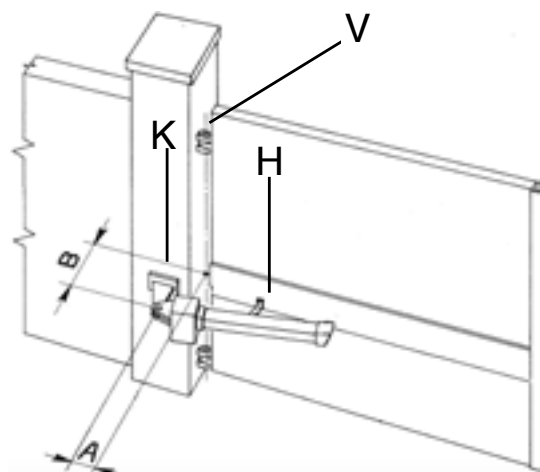

Pillar dimension:

How this influences your gate opener system. Determine the ideal A & B measure

■ **A=** distance between the hinges of the gate and the actuator's post fixing pin. This distance can be chosen by the user. It is recommended to use a measure similar to the "B" measure.

■ **B=** is the most relevant measure and determines gate opening speed and max. opening angle. It's determined by the pillar dimension + fixing bracket.

Shorter B measure determines faster opening of your gate.

If you require major opening angle choose a short B measure and longer A measure

V = gate hinges
K = post fixing bracket
H = front fixing bracket

Longer telescopic actuators, allow better mechanical operation given by the greater strength of the lever.

Carefully evaluate the size of the pillars in relation to the tables that you will find in the pages that present the limits of use and

PUSH TO OPEN OPERATION (opens towards outside)

The gate opener is mounted on the inside of the property and pushes your gate out away from the property. PUSH-TO-OPEN.

Check the overall dimensions before installation.

It is recommended not to use the entire stroke of the drive and to install actuators with a certain incidence angle over the gate

Warning: use of telescopic actuators is recommended.

Warning: remember to reverse the polarity of the motor cables when connecting to the electronic board

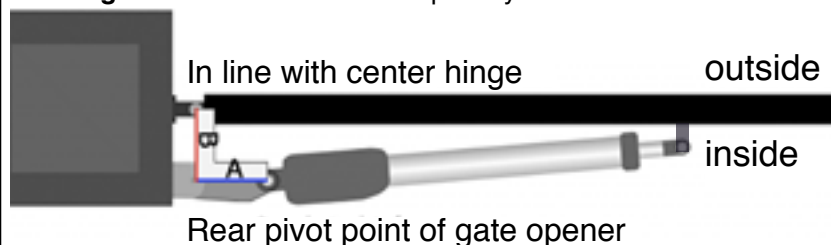

■ **A=** this measure must allow the actuator can open the gate wing at 90 °.

■ **B=** This measure allows the actuator mounting. Compare it to the actuator dimension
Longer telescopic actuators, allow better mechanical operation. Make sure that the gate do not open onto a public passageway. It is advisable to prepare a plant with safety photocells to be placed in such a way that the doors, opening towards the outside do not create damages to things and people who are on the outside of the property, such as parked vehicles.

DUCATI HC312 actuator's installation diagram

- HC312
 - HC312 FC (with on board open position mechanical limit)
- each model is also available in 24V version



Maximal wing dimension:

Maximal wing lenght: up to 2,5m/ 8 ft

Maximal wing weight: up to 250kg/ 500lb

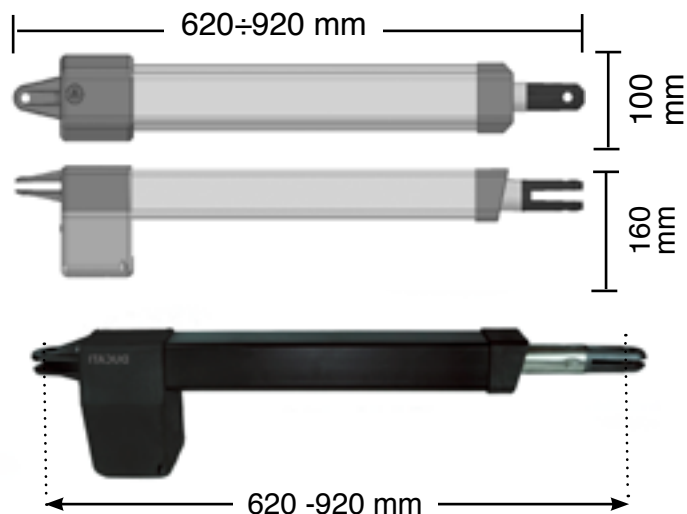

Supplied fixing braket:

choose the hole most suitable to your gate. you can cut the plate if necessary

Post fixing

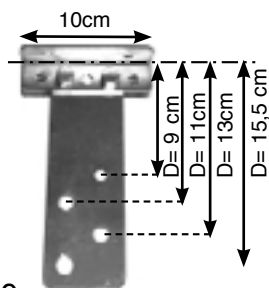

Front fixing

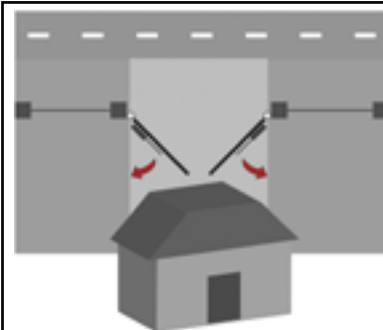
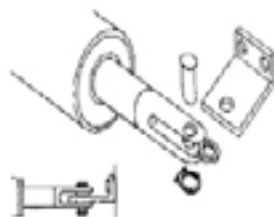

PULL TO OPEN OPERATION (opens towards inside)

This means the gate operator is mounted on the inside of the property and pulls your gate in towards the property to open.

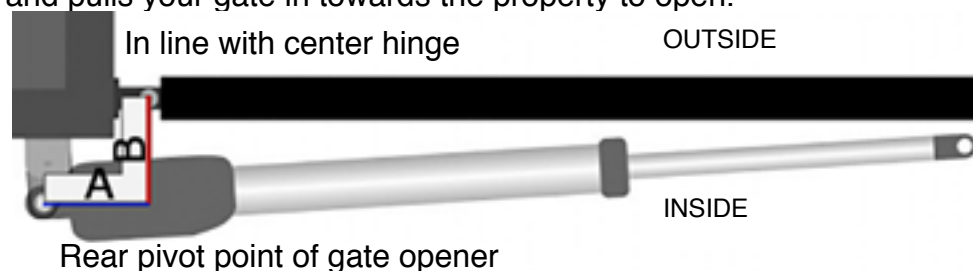

METRIC CONVERSION

1 cm	= 1/2" = 0,3"
10 cm	= 4"
12 cm	= 4 3/4" = 4,7"
14 cm	= 5 1/2" = 5,5"
16 cm	= 6 1/5" = 6,2"
18 cm	= 7"
20 cm	= 7 7/8" = 7,87"
25 cm	= 9 3/4" = 9,8"
30cm	= 11 8/9" = 11,8"

maximal dimension	A=8 cm	A=10 cm	A=12 cm	A=14 cm	A=18 cm	A=20 cm
B=8 cm	98°	110°	118°	125°	108°	100°
B= 10cm	97°	108°	115°	120°	100°	94°
B= 12cm	95°	105°	112°	110°	100°	93°
B= 14cm	95°	103°	109°	98°	/	/
B= 16cm	94°	101°	97°	90°	/	/
B= 18cm	94°	97°	/	/	/	/
B= 20cm	93°	/	/	/	/	/

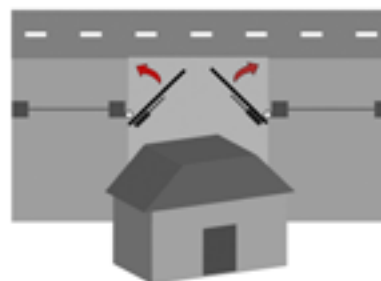

PUSH TO OPEN OPERATION (opens towards outside)

If your driveway slopes up after the gate, preventing it from swinging in. This means the gate operator is mounted on the inside of the property and pushes your gate out away from the property. Warning:remember to reverse the polarity of the motor cables when connecting to the electronic board

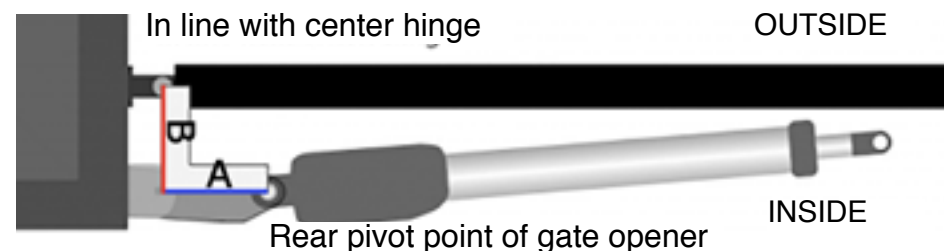

A = min. 8cm
B = min. 8cm max. 14cm

- HC412
 - HC412 FC (with on board open position mechanical limit)
- each model is also available in 24V version



Maximal wing dimension:

Maximal wing lenght: up to 3,5m/ 11 ft

Maximal wing weight: up to 300kg/ 660lb

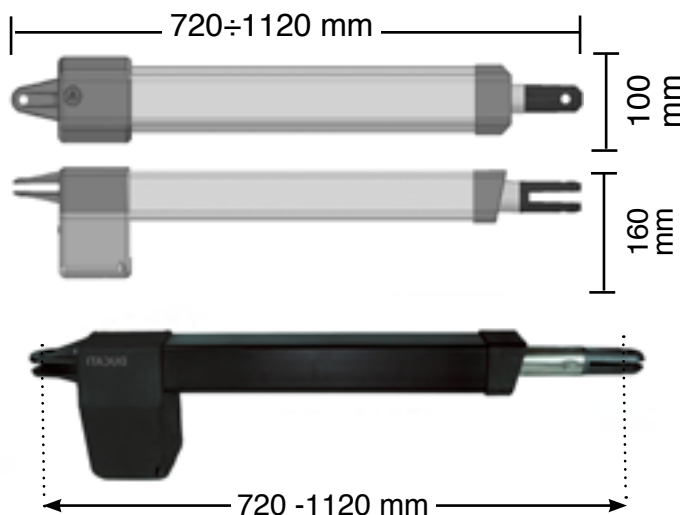

Supplied fixing bracket:

choose the hole most suitable to your gate. you can cut the plate if necessary

Post fixing

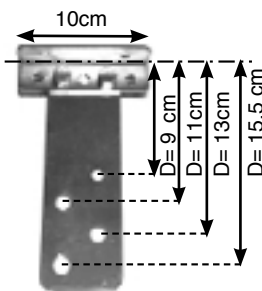

Front fixing

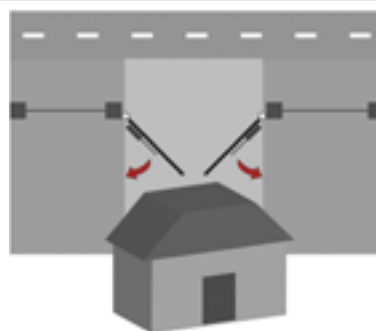
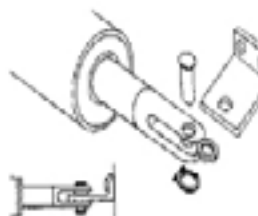

PULL TO OPEN OPERATION (opens towards inside)

This means the gate operator is mounted on the inside of the property and pulls your gate in towards the property to open.

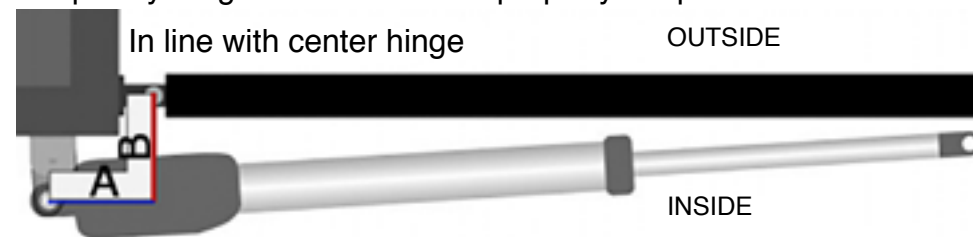

Rear pivot point of gate opener

METRIC CONVERSION

1 cm = 1/2" = 0,3"
10 cm = 4"
12 cm = 4 3/4" = 4,7"
14 cm = 5 1/2" = 5,5"
16 cm = 6 1/5" = 6,2"
18 cm = 7"
20 cm = 7 7/8" = 7,87"
25 cm = 9 3/4" = 9,8"
28 cm = 11"

TAB	A= 8cm	A= 10cm	A= 12cm	A= 14cm	A= 16 cm	A= 18cm	A= 20cm	A= 22cm	A= 24cm	A= 26cm	A= 28cm
B= 8cm	16 sec/97°	18sec/110°	21sec/118°	23sec/125°	23sec/130°	24sec/135°	26sec/137°	27sec/115°	31sec/108°	32sec/103°	32sec/105°
B= 10cm	18sec/98°	19sec/107°	22sec/114°	23sec/121°	25sec/127°	27sec/131°	27sec/125°	29sec/115°	31sec/108°	32sec/103°	33sec/99°
B= 12cm	20sec/98°	23sec/105°	24sec/112°	26sec/118°	27sec/124°	29sec/127°	30sec/120°	33sec/110°	34sec/104°	35sec/100°	369sec/96°
B= 14cm	21sec/95°	24sec/103°	25sec/108°	27sec/105°	28sec/120°	30sec/125°	32sec/111°	33sec/105°	35sec/99°	36sec/95°	37sec/93°
B= 16cm	23sec/94°	25sec/102°	28sec/108°	30sec/103°	31sec/118°	33sec/113°	34sec/102°	35sec/98°	37sec/94°	38sec/90°	
B= 18cm	26sec/94°	27sec/100°	29sec/106°	32sec/111°	33sec/115°	34sec/105°	36sec/97°	36sec/93°	38sec/90°		
B= 20cm	28sec/94°	30sec/100°	32sec/105°	34sec/109°	35sec/103°	37sec/96°	40sec/90°				
B= 22cm	29sec/93°	33sec/99°	33sec/103°	34sec/106°	37sec/95°	38sec/90°					
B= 24cm	32sec/93°	34sec/99°	36sec/102°	37sec/93°							
B= 26cm	34sec/93°	36sec/98°	37sec/92°								
B= 28cm	38sec/93°										

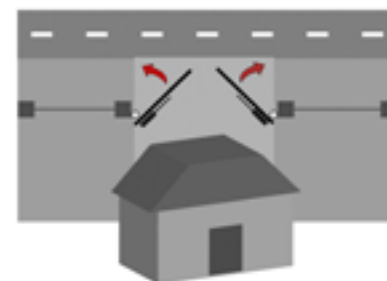

PUSH TO OPEN OPERATION (opens towards outside)

If your driveway slopes up after the gate, preventing it from swinging in. This means the gate operator is mounted on the inside of the property and pushes your gate out away from the property. Warning:remember to reverse the polarity of the motor cables when connecting to the electronic board

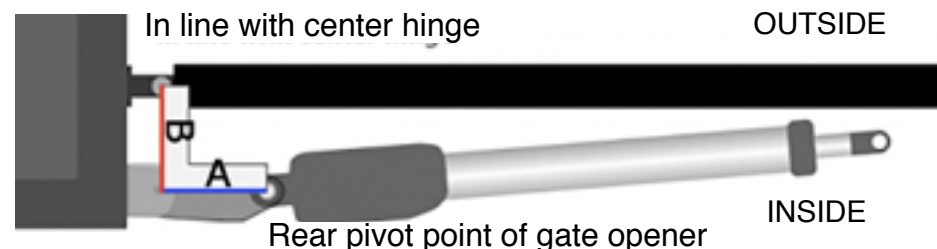

A = min. 8cm
B = min. 8cm max. 14cm

Rear pivot point of gate opener

DUCATI HC512 actuator's installation diagram

- HC512
 - HC512 FC (with on board open position mechanical limit)
- each model is also available in 24V version



Maximal wing dimension:

Maximal wing lenght: up to 4m/ 14 ft
 Maximal wing weight: up to 400kg/ 860lb

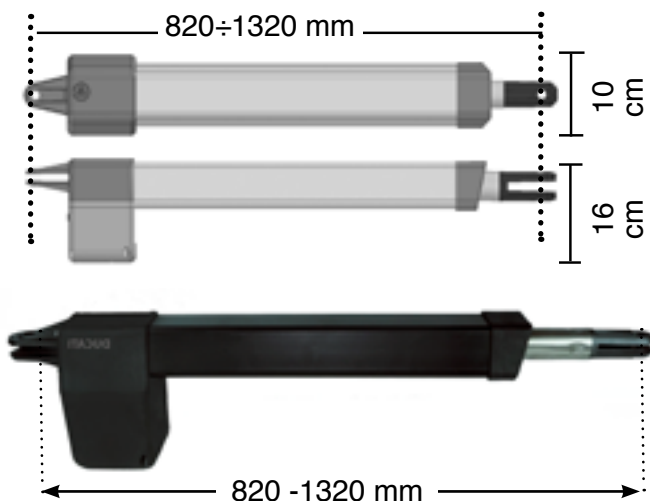

Supplied fixing braket:

choose the hole most suitable to your gate. you can cut the plate if necessary

Post fixing

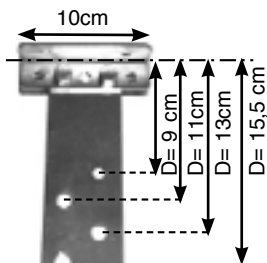

Front fixing

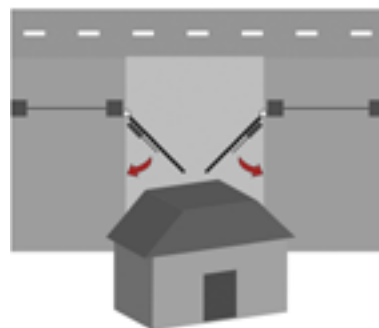
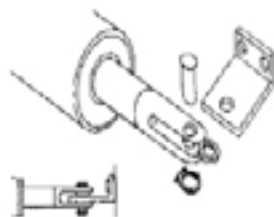

PULL TO OPEN OPERATION (opens towards inside)

This means the gate operator is mounted on the inside of the property and pulls your gate in towards the property to open.

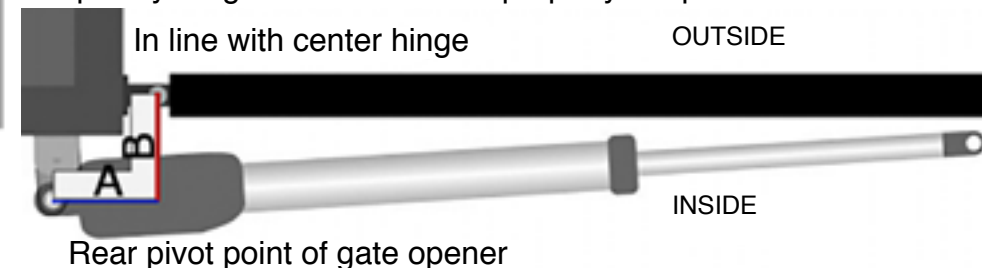

METRIC CONVERSION

1 cm = 1/2" = 0,3"
 10 cm = 4"
 12 cm = 4 3/4" = 4,7"
 14 cm = 5 1/2" = 5,5"
 16 cm = 6 1/5" = 6,2"
 18 cm = 7"
 20 cm = 7 7/8" = 7,87"
 25 cm = 9 3/4" = 9,8"
 30cm = 11 8/9" = 11,8"

TAB	A= 8cm	A= 10cm	A= 12cm	A= 14cm	A= 16 cm	A= 18cm	A= 20cm	A= 22cm	A= 24cm	A= 26cm	A= 28cm
B= 8cm	16 sec/97°	18sec/110°	21sec/118°	23sec/125°	23sec/130°	24sec/135°	26sec/137°	27sec/115°	31sec/108°	32sec/103°	32sec/105°
B= 10cm	18sec/98°	19sec/107°	22sec/114°	23sec/121°	25sec/127°	27sec/131°	27sec/125°	29sec/115°	31sec/108°	32sec/103°	33sec/99°
B= 12cm	20sec/98°	23sec/105°	24sec/112°	26sec/118°	27sec/124°	29sec/127°	30sec/120°	33sec/110°	34sec/104°	35sec/100°	369sec/96°
B= 14cm	21sec/95°	24sec/103°	25sec/108°	27sec/105°	28sec/120°	30sec/125°	32sec/111°	33sec/105°	35sec/99°	36sec/95°	37sec/93°
B= 16cm	23sec/94°	25sec/102°	28sec/108°	30sec/103°	31sec/118°	33sec/113°	34sec/102°	35sec/98°	37sec/94°	38sec/90°	
B= 18cm	26sec/94°	27sec/100°	29sec/106°	32sec/111°	33sec/115°	34sec/105°	36sec/97°	36sec/93°	38sec/90°		
B= 20cm	28sec/94°	30sec/100°	32sec/105°	34sec/109°	35sec/103°	37sec/96°	40sec/90°				
B= 22cm	29sec/93°	33sec/99°	33sec/103°	34sec/106°	37sec/95°	38sec/90°					
B= 24cm	32sec/93	34sec/99	36sec/102	37sec/93°							
B= 26cm	34sec/93°	36sec/98°	37sec/92°								
B= 30cm	38sec/93°										

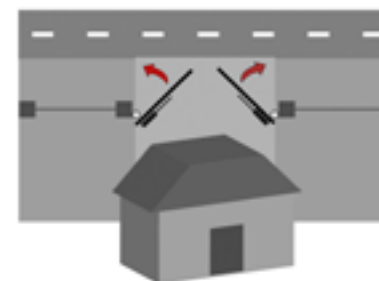

PUSH TO OPEN OPERATION (opens towards inside)

If your driveway slopes up after the gate, preventing it from swinging in. This means the gate operator is mounted on the inside of the property and pushes your gate out away from the property. Warning: remember to reverse the polarity of the motor cables when connecting to the electronic board

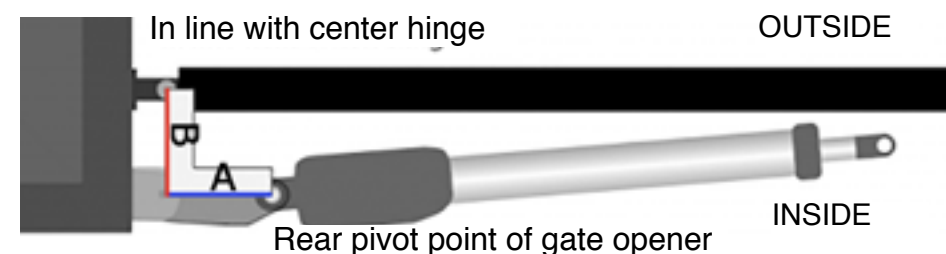

A = min. 8cm
 B = min. 8cm max. 14cm

DUCATI HC612 actuator's installation diagram

- HC612
 - HC612 FC (with on board open position mechanical limit)
- each model is also available in 24V version



Maximal wing dimension:

Maximal wing lenght: up to 5m/ 16 ft
 Maximal wing weight: up to 500kg/ 110lb

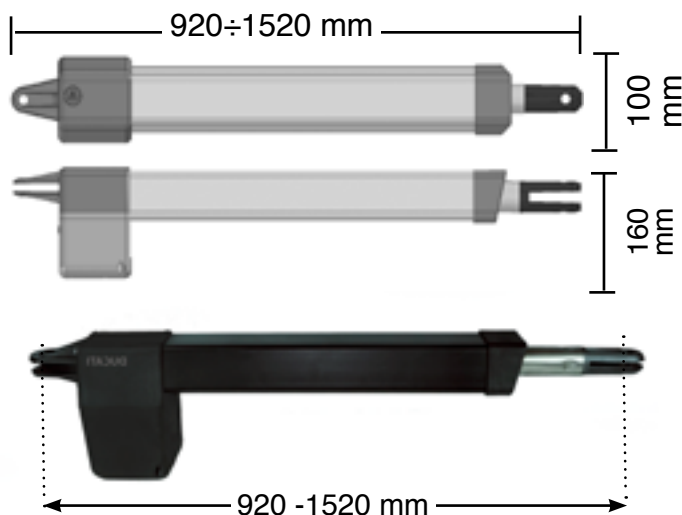

Supplied fixing bracket:

choose the hole most suitable to your gate. you can cut the plate if necessary

Post fixing

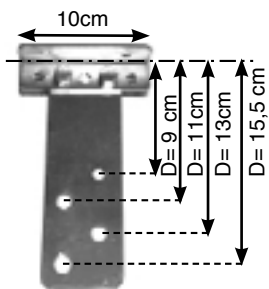

Front fixing

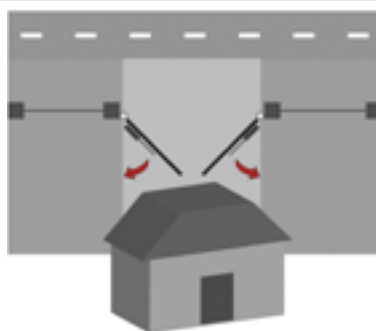
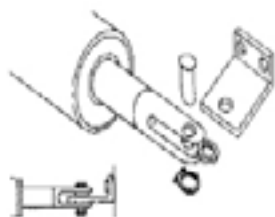

PULL TO OPEN OPERATION (opens towards inside)

This means the gate operator is mounted on the inside of the property and pulls your gate in towards the property to open.

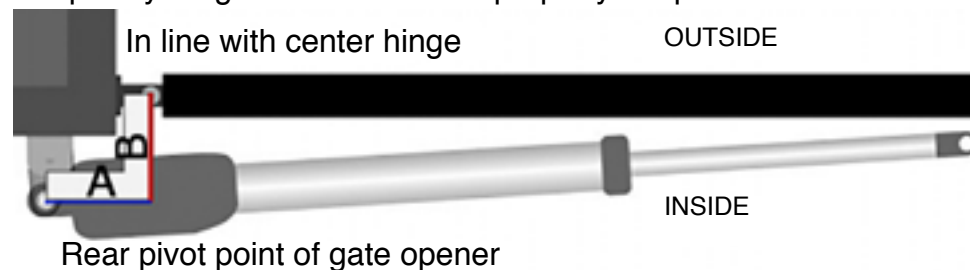

METRIC CONVERSION

1 cm = 1/2" = 0,3"
 10 cm = 4"
 12 cm = 4 3/4" = 4,7"
 14 cm = 5 1/2" = 5,5"
 16 cm = 6 1/5" = 6,2"
 18 cm = 7"
 20 cm = 7 7/8" = 7,87"
 25 cm = 9 3/4" = 9,8"
 35cm = 13 4/5" = 13,7"

TAB	A= 8cm	A= 10cm	A= 12cm	A= 14cm	A= 16 cm	A= 18cm	A= 20cm	A= 22cm	A= 24cm	A= 26cm	A= 28cm
B= 8cm	16 sec/97°	18sec/110°	21sec/118°	23sec/125°	23sec/130°	24sec/135°	26sec/137°	27sec/115°	31sec/108°	32sec/103°	32sec/105°
B= 10cm	18sec/98°	19sec/107°	22sec/114°	23sec/121°	25sec/127°	27sec/131°	27sec/125°	29sec/115°	31sec/108°	32sec/103°	33sec/99°
B= 12cm	20sec/98°	23sec/105°	24sec/112°	26sec/118°	27sec/124°	29sec/127°	30sec/120°	33sec/110°	34sec/104°	35sec/100°	369sec/96°
B= 14cm	21sec/95°	24sec/103°	25sec/108°	27sec/105°	28sec/120°	30sec/125°	32sec/111°	33sec/105°	35sec/99°	36sec/95°	37sec/93°
B= 16cm	23sec/94°	25sec/102°	28sec/108°	30sec/103°	31sec/118°	33sec/113°	34sec/102°	35sec/98°	37sec/94°	38sec/90°	
B= 18cm	26sec/94°	27sec/100°	29sec/106°	32sec/111°	33sec/115°	34sec/105°	36sec/97°	36sec/93°	38sec/90°		
B= 20cm	28sec/94°	30sec/100°	32sec/105°	34sec/109°	35sec/103°	37sec/96°	40sec/90°				
B= 22cm	29sec/93°	33sec/99°	33sec/103°	34sec/106°	37sec/95°	38sec/90°					
B= 24cm	32sec/93	34sec/99	36sec/102	37sec/93°							
B= 26cm	34sec/93°	36sec/98°	37sec/92°								
B= 35cm	38sec/93°										

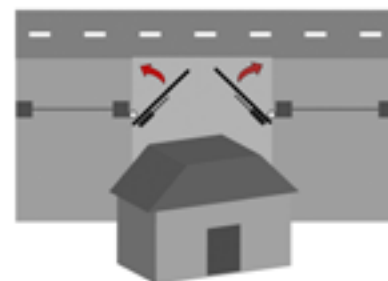

PUSH TO OPEN OPERATION (opens towards outside)

If your driveway slopes up after the gate, preventing it from swinging in. This means the gate operator is mounted on the inside of the property and pushes your gate out away from the property. Warning:remember to reverse the polarity of the motor cables when connecting to the electronic board

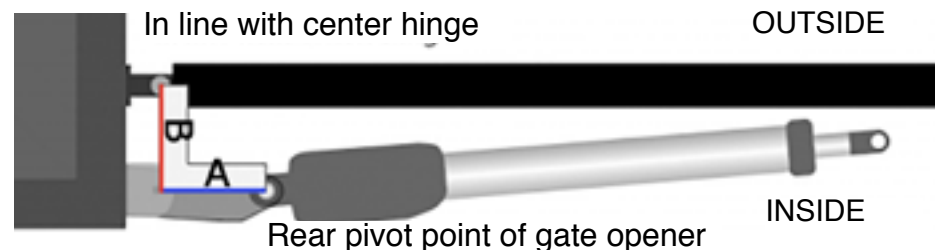

A = min. 8cm
 B = min. 8cm max. 14cm

DUCATI HC418 actuator's installation diagram

- HC418
 - HC418 FC (with on board open & closed position mechanical limits)
- each model is also available in 24V version



Maximal wing dimension:

Maximal wing length: up to 2m/ 6,5 ft

Maximal wing weight: up to 200kg/ 440lb

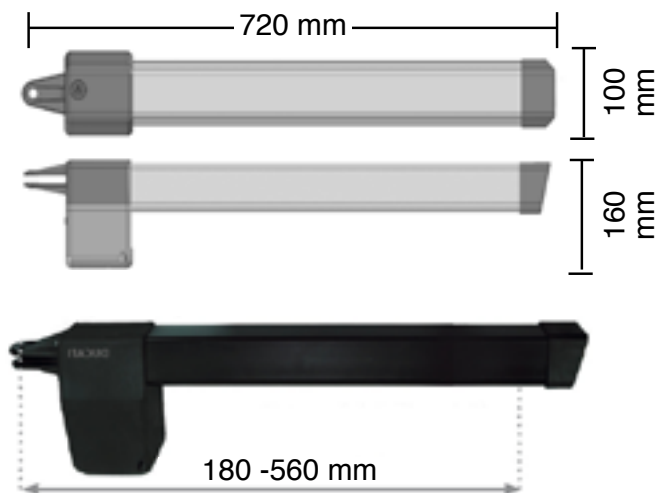

Supplied fixing bracket:

choose the hole most suitable to your gate.
You can cut the plate if necessary

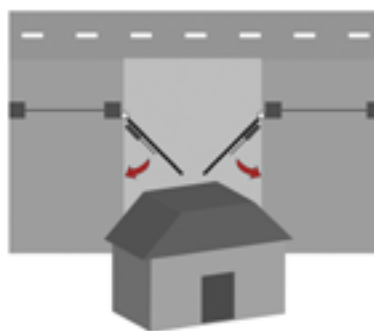
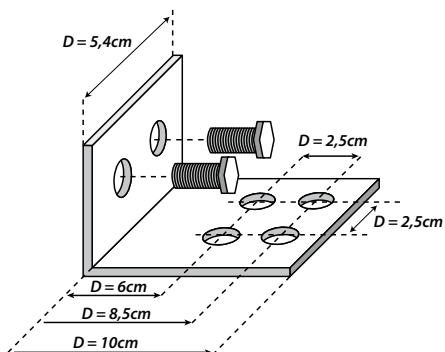

PULL TO OPEN OPERATION (opens towards inside)

This means the gate operator is mounted on the inside of the property and pulls your gate in towards the property to open.

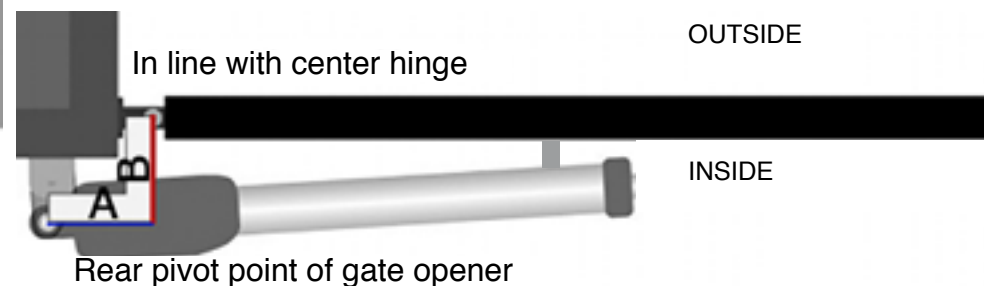

maximal dimension	A=10 cm	A=12cm	A=14 cm	A=18 cm
B= 10cm	108°	115°	120°	100°
B= 12cm	105°	112°	100°	100°
B= 14cm	103°	109°	98°	/
B= 16cm	101°	97°	90°	/
B= 18cm	97°	/	/	/

METRIC CONVERSION

1 cm = 1/2" = 0,3"
 10 cm = 4"
 12 cm = 4 3/4" = 4,7"
 14 cm = 5 1/2" = 5,5"
 16 cm = 6 1/5" = 6,2"
 18 cm = 7"

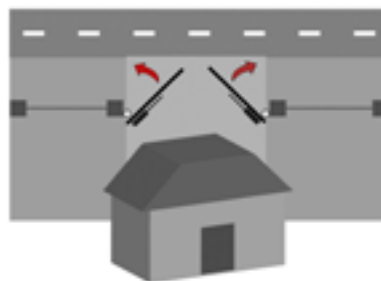

PUSH TO OPEN OPERATION (opens towards outside)

If your driveway slopes up after the gate, preventing it from swinging in. This means the gate operator is mounted on the inside of the property and pushes your gate out away from the property.
Warning: only compatible with telescopic tube actuators, Check the overall dimensions before installation.

Warning: remember to reverse the polarity of the motor cables when connecting to the electronic board

NOT POSSIBLE WITH THIS ACTUATOR MODEL: IT REQUIRES TELESCOPIC ACTUATORS

- HC518
 - HC518 FC (with on board open& closed position mechanical limits)
- each model is also available in 24V version



Maximal wing dimension:

Maximal wing lenght: up to 3m/ 8,5 ft

Maximal wing weight: up to 300kg/ 760lb

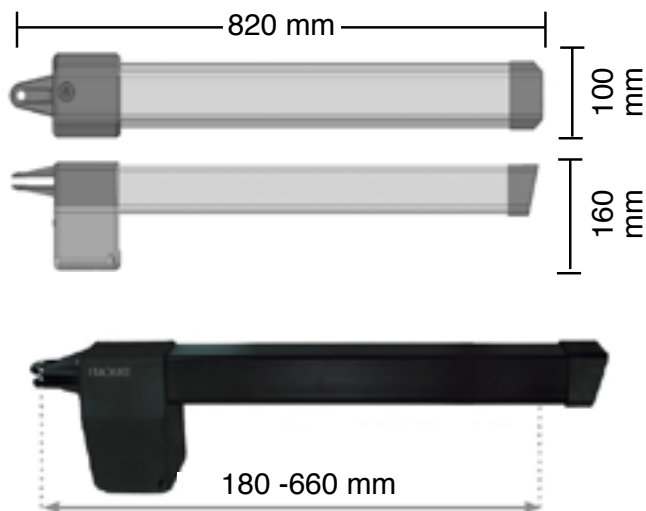

Supplied fixing braket:

choose the hole most suitable to your gate.
You can cut the plate if necessary

Post fixing

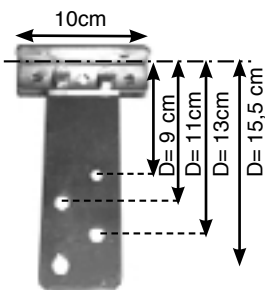

Front fixing

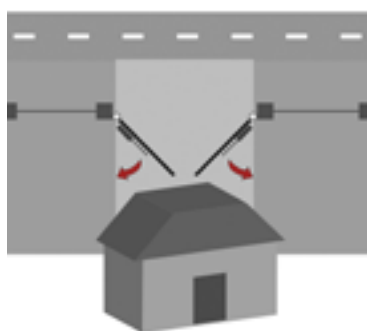
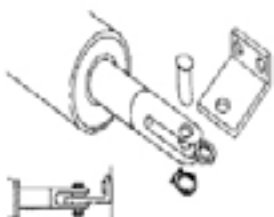

PULL TO OPEN OPERATION (opens towards inside)

This means the gate operator is mounted on the inside of the property and pulls your gate in towards the property to open.

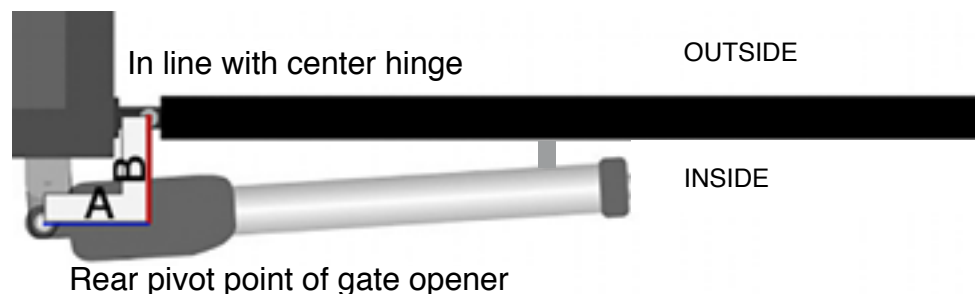

maximal dimension	A=10 cm	A=12cm	A=14 cm	A=18 cm
B= 10cm	108°	115°	120°	100°
B= 12cm	105°	112°	100°	100°
B= 14cm	103°	109°	98°	/
B= 16cm	101°	97°	90°	/
B= 18cm	97°	/	/	/
B = 22 cm	90°	/	/	/

METRIC CONVERSION

- 1 cm = 1/2" = 0,3"
- 10 cm = 4"
- 12 cm = 4 3/4" = 4,7"
- 14 cm = 5 1/2" = 5,5"
- 16 cm = 6 1/5" = 6,2"
- 18 cm = 7"

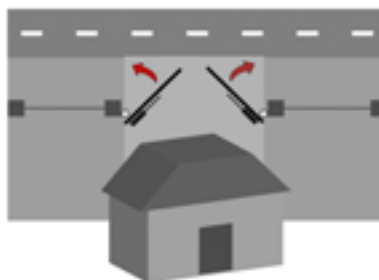

PUSH TO OPEN OPERATION (opens towards outside)

If your driveway slopes up after the gate, preventing it from swinging in. This means the gate operator is mounted on the inside of the property and pushes your gate out away from the property. Warning: only compatible with telescopic tube actuators, Check the overall dimensions before installation.

Warning:remember to reverse the polarity of the motor cables when connecting to the electronic board

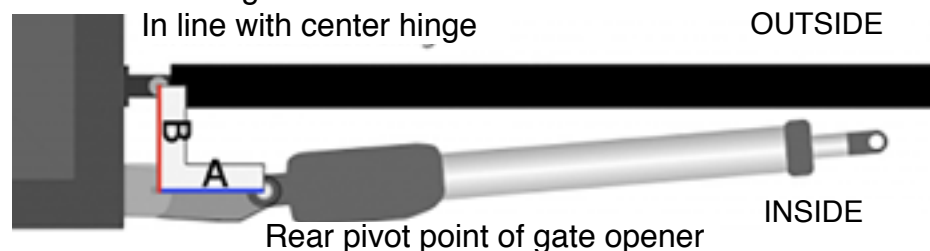

A = min. 8cm
B = min. 8cm max. 14cm

DUCATI HC618 actuator's installation diagram

- HC618
 - HC618 FC (with on board open& closed position mechanical limits)
- each model is also available in 24V version



Maximal wing dimension:

Maximal wing lenght: up to 3m/ 10 ft
 Maximal wing weight: up to 300kg/ 760lb

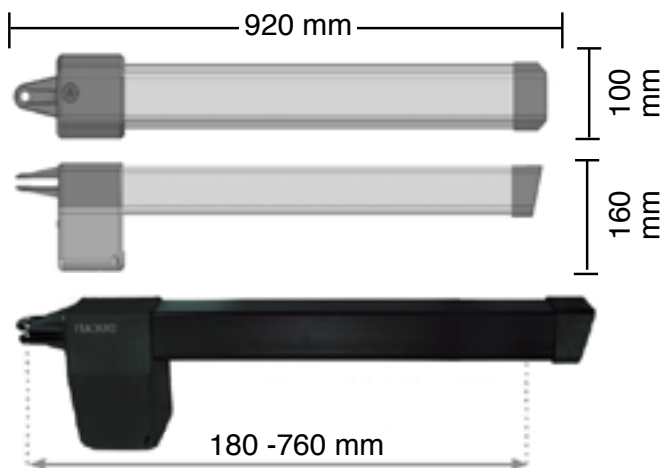

Supplied fixing bracket:

choose the hole most suitable to your gate.
 You can cut the plate if necessary

Post fixing

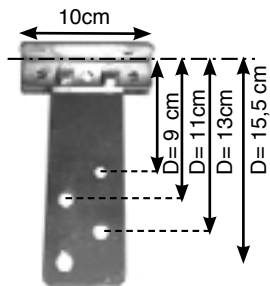

Front fixing

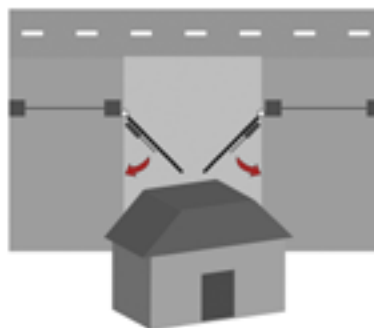
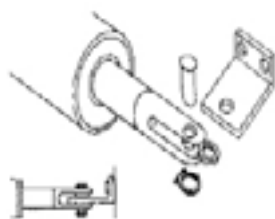

PULL TO OPEN OPERATION (opens towards inside)

This means the gate operator is mounted on the inside of the property and pulls your gate in towards the property to open.

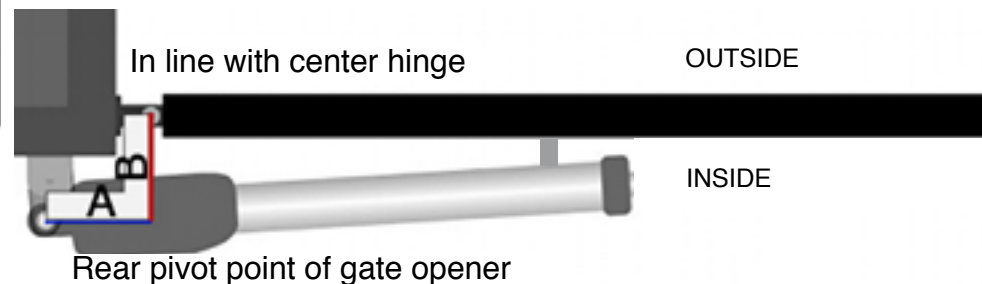

maximal dimension	A=8 cm	A=12cm	A=14 cm	A=18 cm
B= 10cm	108°	115°	120°	100°
B= 12cm	105°	112°	100°	100°
B= 14cm	103°	109°	98°	/
B= 16cm	101°	97°	90°	/
B= 18cm	97°	/	/	/
B = 25 cm	90 °	/	/	/

METRIC CONVERSION

1 cm = 1/2" = 0,3"
 10 cm = 4"
 12 cm = 4 3/4" = 4,7"
 14 cm = 5 1/2" = 5,5"
 16 cm = 6 1/5" = 6,2"
 18 cm = 7"

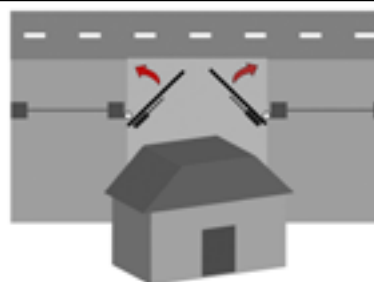

PUSH TO OPEN OPERATION (opens towards inside)

If your driveway slopes up after the gate, preventing it from swinging in. This means the gate operator is mounted on the inside of the property and pushes your gate out away from the property.
 Warning:remember to reverse the polarity of the motor cables when connecting to the electronic board

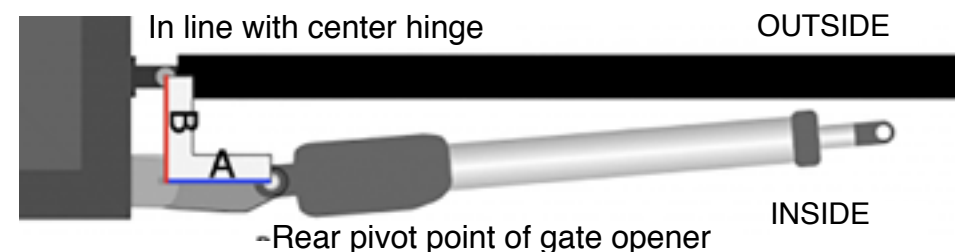

A = min. 8cm
 B = min. 8cm max. 14cm

- SW400
 - SW400 FC (with on board open & closed position mechanical limits)
- each model is also available in 24V version



Maximal wing dimension:

Maximal wing lenght: **up to 2m/ 6,5 ft**

Maximal wing weight: up to 200kg/ 440lb

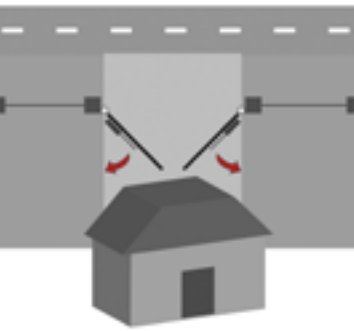
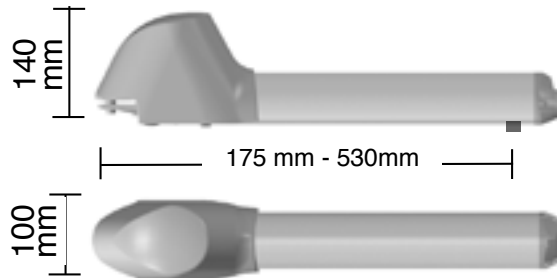

PULL TO OPEN OPERATION (opens towards inside)

This means the gate operator is mounted on the inside of the property and pulls your gate in towards the property to open.

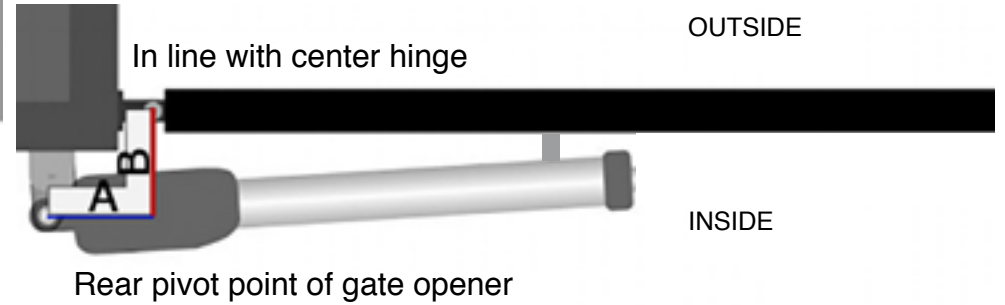

METRIC CONVERSION

1 cm = 1/2" = 0,3"
 10 cm = 4"
 12 cm = 4 3/4" = 4,7"
 14 cm = 5 1/2" = 5,5"
 16 cm = 6 1/5" = 6,2"
 18 cm = 7"

TAB	A=10 cm	A=12cm	A=14 cm	A=18 cm
B= 10cm	108°	115°	120°	100°
B= 12cm	105°	112°	100°	100°
B= 14cm	103°	109°	98°	/
B= 16cm	101°	97°	90°	/
B= 18cm	97°	/	/	/

Supplied fixing bracket:

choose the hole most suitable to your gate.
 You can cut the plate if necessary

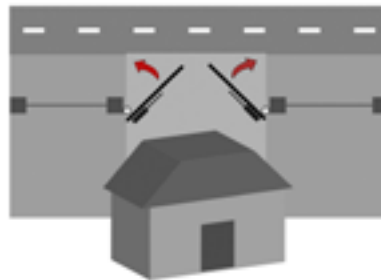
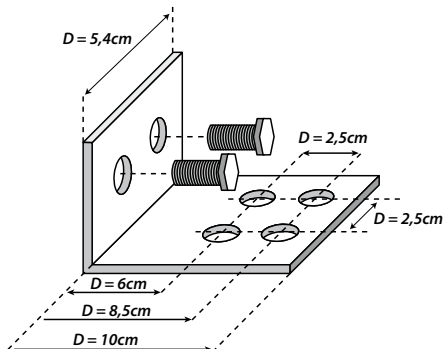

PUSH TO OPEN OPERATION (opens towards outside)

If your driveway slopes up after the gate, preventing it from swinging in. This means the gate operator is mounted on the inside of the property and pushes your gate out away from the property.

Warning: only compatible with telescopic tube actuators, Check the overall dimensions before installation.

Warning:remember to reverse the polarity of the motor cables when connecting to the electronic board

NOT POSSIBLE WITH THIS ACTUATOR MODEL: IT REQUIRES TELESCOPIC ACTUATORS

- SW400 T
 - SW400T FC (with on board open position mechanical limit)
- each model is also available in 24V version



Maximal wing dimension:

Maximal wing lenght: up to 2,6m/ 8,5 ft

Maximal wing weight: up to 250kg/ 500lb

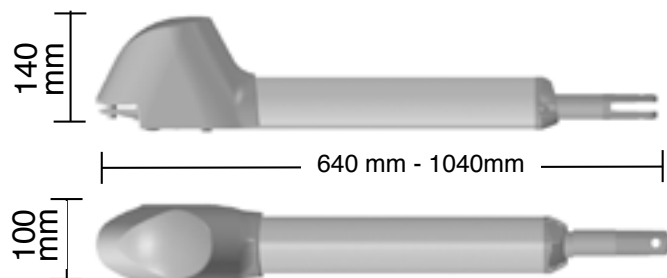

Supplied fixing braket:

choose the hole most suitable to your gate. you can cut the plate if necessary

Post fixing

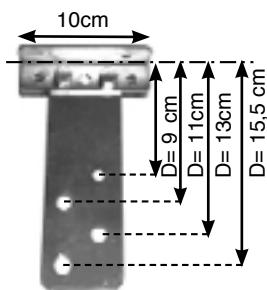

Front fixing

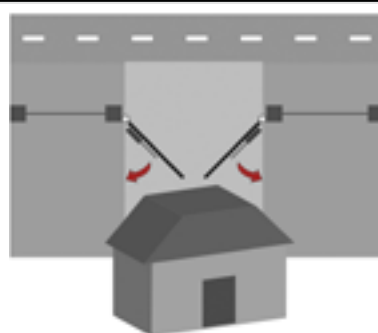
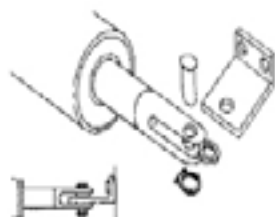

PULL TO OPEN OPERATION (opens towards inside)

This means the gate operator is mounted on the inside of the property and pulls your gate in towards the property to open.

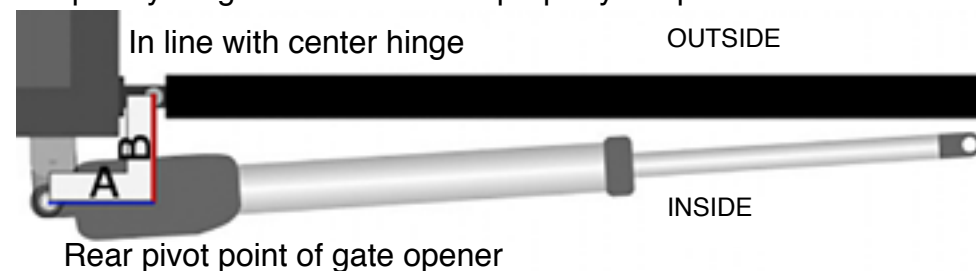

METRIC CONVERSION

1 cm = 1/2" = 0,3"
10 cm = 4"
12 cm = 4 3/4" = 4,7"
14 cm = 5 1/2" = 5,5"
16 cm = 6 1/5" = 6,2"
18 cm = 7"
20 cm = 7 7/8" = 7,87"
25 cm = 9 3/4" = 9,8"
28 cm = 11"

TAB 3	A= 8cm	A= 10cm	A= 12cm	A= 14cm	A= 16 cm	A= 18cm	A= 20cm	A= 22cm	A= 24cm	A= 26cm	A= 28cm
B= 8cm	16 sec/97°	18sec/110°	21sec/118°	23sec/125°	23sec/130°	24sec/135°	26sec/137°	27sec/115°	31sec/108°	32sec/103°	32sec/105°
B= 10cm	18sec/98°	19sec/107°	22sec/114°	23sec/121°	25sec/127°	27sec/131°	27sec/125°	29sec/115°	31sec/108°	32sec/103°	33sec/99°
B= 12cm	20sec/98°	23sec/105°	24sec/112°	26sec/118°	27sec/124°	29sec/127°	30sec/120°	33sec/110°	34sec/104°	35sec/100°	369sec/96°
B= 14cm	21sec/95°	24sec/103°	25sec/108°	27sec/105°	28sec/120°	30sec/125°	32sec/111°	33sec/105°	35sec/99°	36sec/95°	37sec/93°
B= 16cm	23sec/94°	25sec/102°	28sec/108°	30sec/103°	31sec/118°	33sec/113°	34sec/102°	35sec/98°	37sec/94°	38sec/90°	
B= 18cm	26sec/94°	27sec/100°	29sec/106°	32sec/111°	33sec/115°	34sec/105°	36sec/97°	36sec/93°	38sec/90°		
B= 20cm	28sec/94°	30sec/100°	32sec/105°	34sec/109°	35sec/103°	37sec/96°	40sec/90°				
B= 22cm	29sec/93°	33sec/99°	33sec/103°	34sec/106°	37sec/95°	38sec/90°					
B= 24cm	32sec/93°	34sec/99°	36sec/102°	37sec/93°							
B= 26cm	34sec/93°	36sec/98°	37sec/92°								
B= 28cm	38sec/93°										

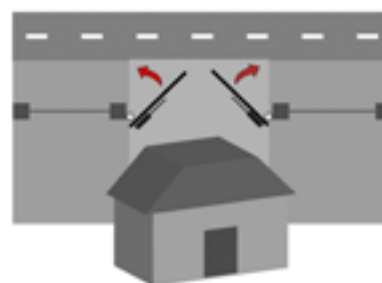

PUSH TO OPEN OPERATION (opens towards outside)

If your driveway slopes up after the gate, preventing it from swinging in. This means the gate operator is mounted on the inside of the property and pushes your gate out away from the property. Warning: only compatible with telescopic tube actuators, Check the overall dimensions before installation.

Warning: remember to reverse the polarity of the motor cables when connecting to the electronic board

A = min. 8cm
B = min. 8cm max. 14cm

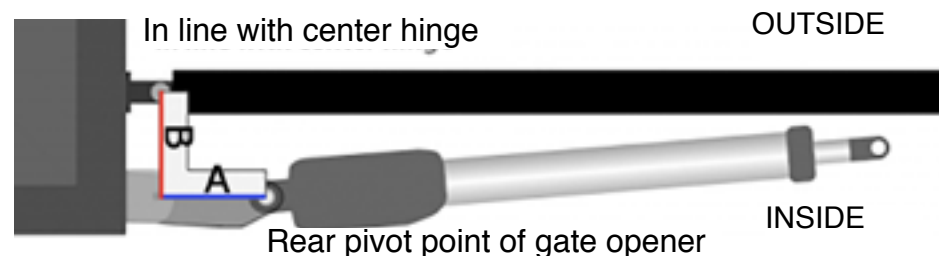

- EVO 700
 - EVO 700 FC (with on board open & closed position mechanical limits)
- each model is also available in 24V version



Maximal wing dimension:

Maximal wing length: up to 4m/ 14 ft
 Maximal wing weight: up to 350kg/ 760lb

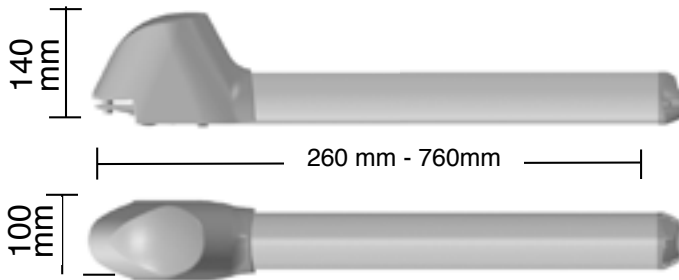

Multi-position fixing bracket:

choose the hole most suitable to your gate.

front fixing bracket

multiposition post fixing bracket

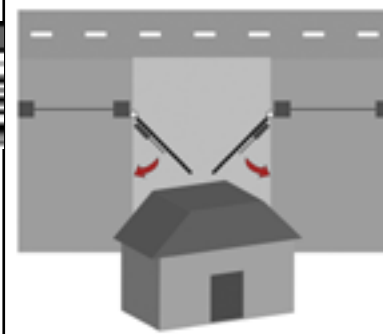
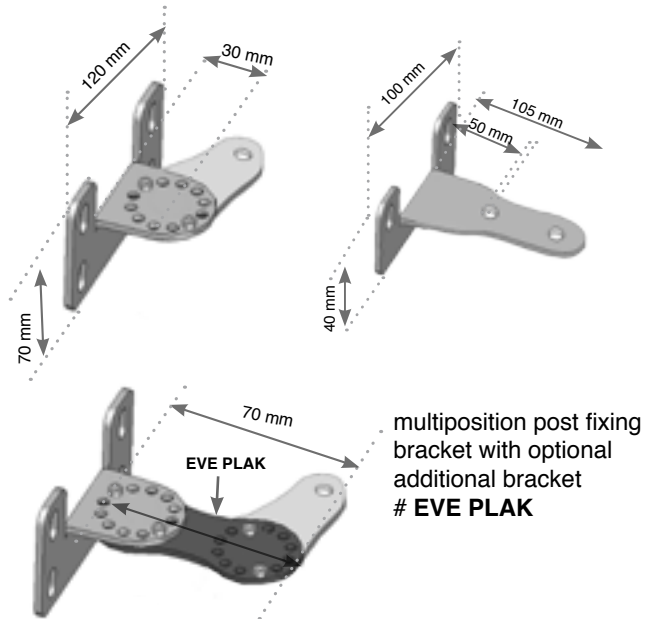

PULL TO OPEN OPERATION (opens towards inside)

This means the gate operator is mounted on the inside of the property and pulls your gate in towards the property to open.

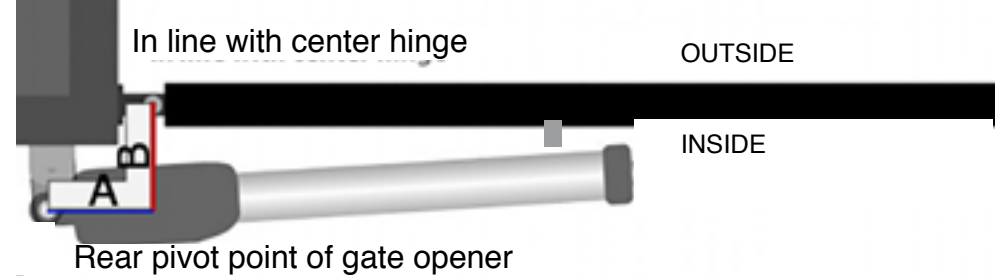

measures are in cm

METRIC CONVERSION

- 1 cm = 1/2" = 0,3"
- 10 cm = 4"
- 12 cm = 4 3/4" = 4,7"
- 14 cm = 5 1/2" = 5,5"
- 16 cm = 6 1/5" = 6,2"
- 18 cm = 7"
- 20 cm = 7 7/8" = 7,87"
- 25 cm = 9 3/4" = 9,8"
- 35 cm = 13 4/5" = 13,7"

TAB	A-9	A-11	A-13	A-15	A-17	A-19	A-21	A-23	A-25
B-8	105°12sec	115°15sec	125°15sec	130°20sec	130°27sec	140°25sec	135°27sec	90°	105°
B-9	105°13sec	115°15sec	120°18sec	125°20sec	130°23sec	135°25sec	120°	90°	105°
B-12	100°14sec	110°17sec	115°19sec	120°21sec	120°23sec	125°26sec	120°	90°	105°
B-15	105°17sec	105°19sec	110°21sec	115°23sec	120°26sec	125°28sec	125°30sec		
B-18	100°18sec	105°20sec	110°23sec	115°25sec	115°27sec	120°29sec	100°28sec		
B-21	105°20sec	100°22sec	105°24sec	110°26sec	110°28sec				
B-25	95°23sec	100°25sec	105°27sec	110°29sec	110°31sec				
B-29	95°27sec	100°28sec	100°30sec	105°32sec					
B-33	95°30sec	95°32sec	90°32sec						
B-35	95°32sec	95°33sec							

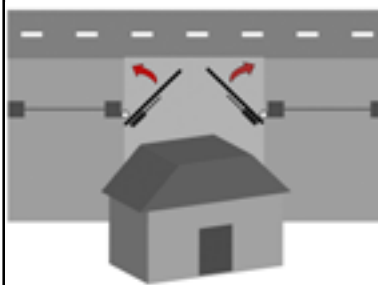

PUSH TO OPEN OPERATION (opens towards outside)

If your driveway slopes up after the gate, preventing it from swinging in. This means the gate operator is mounted on the inside of the property and pushes your gate out away from the property. Warning: only compatible with telescopic tube actuators, Check the overall dimensions before installation.

Warning: remember to reverse the polarity of the motor cables when connecting to the electronic board

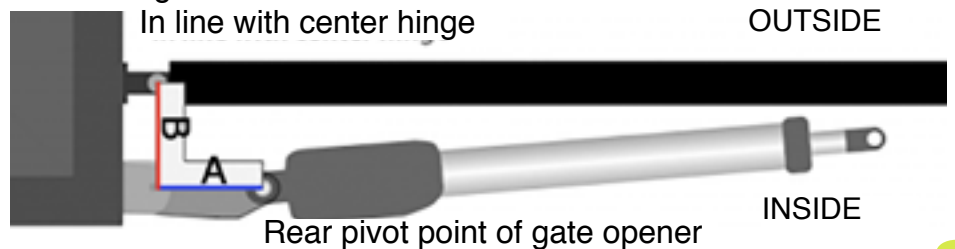

A = min. 8cm
 B = min. 8cm max. 14cm

DUCATI EVO 700T actuator's installation diagram

- EVO 700 T
 - EVO 700 T FC (with on board open position mechanical limit)
- each model is also available in 24V version



Maximal wing dimension:

Maximal wing lenght: up to 5m/ 16 ft

Maximal wing weight: up to 350kg/ 760lb

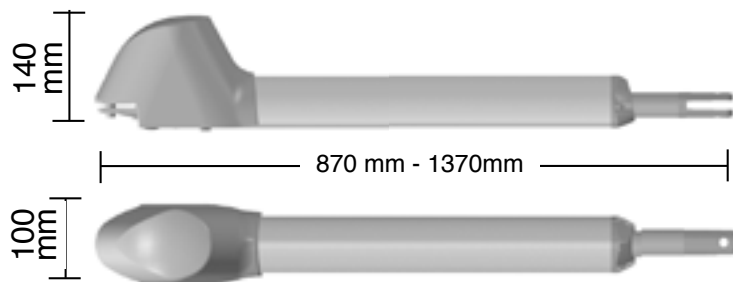

Multi-position fixing bracket:

choose the hole most suitable to your gate.

front fixing bracket

multiposition post fixing bracket

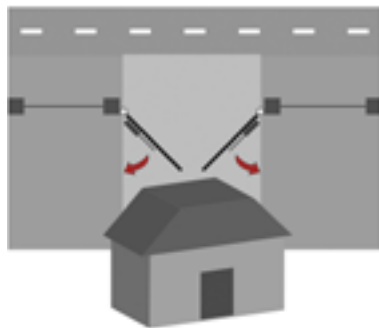
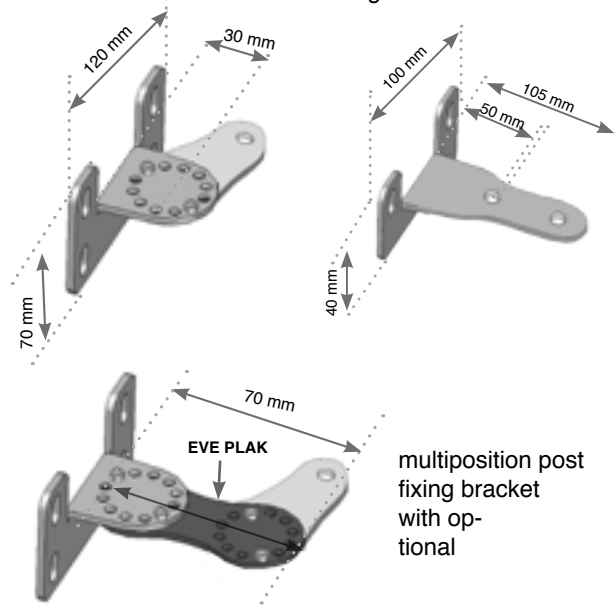

PULL TO OPEN OPERATION (opens towards inside)

This means the gate operator is mounted on the inside of the property and pulls your gate in towards the property to open.

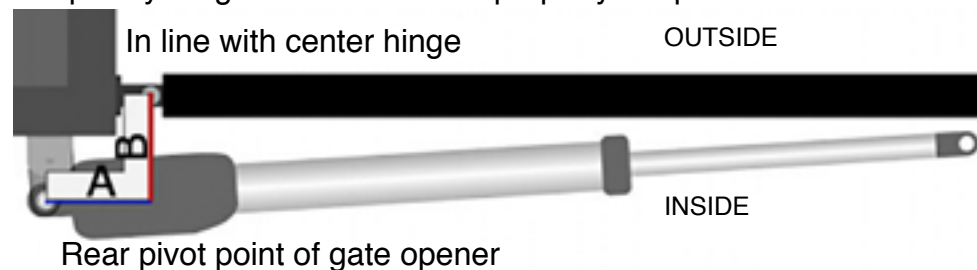

Rear pivot point of gate opener

measures are in cm

METRIC CONVERSION

- 1 cm = 1/2" = 0,3"
- 10 cm = 4"
- 12 cm = 4 3/4" = 4,7"
- 14 cm = 5 1/2" = 5,5"
- 16 cm = 6 1/5" = 6,2"
- 18 cm = 7"
- 20 cm = 7 7/8" = 7,87"
- 25 cm = 9 3/4" = 9,8"
- 35cm = 13 4/5" = 13,7"

TAB	A-9	A-11	A-13	A-15	A-17	A-19	A-21	A-23	A-25
B-9	105°21sec	115°22sec	120°23sec	120°23sec	125°23sec	130°25sec	135°26sec	135°26sec	120°23sec
B-11	105°21sec	115°22sec	115°22sec	115°22sec	120°23sec	125°23sec	130°25sec	90°18sec	115°22sec
B-13	100°20sec	105°21sec	110°21sec	115°22sec	115°22sec	120°23sec	125°23sec	125°23sec	105°21sec
B-15	105°17sec	105°19sec	110°21sec	115°23sec	120°26sec	125°28sec	125°30sec	125°23sec	105°21sec
B-18	100°18sec	105°20sec	110°23sec	115°25sec	115°27sec	120°29sec	100°28sec	105°21sec	100°20sec
B-21	105°20sec	100°22sec	105°24sec	110°26sec	110°28sec				
B-25	95°23sec	100°25sec	105°27sec	110°29sec	110°31sec				
B-29	95°27sec	100°28sec	100°30sec	105°32sec					
B-33	95°30sec	95°32sec	90°32sec						
B-35	95°32sec	95°33sec							

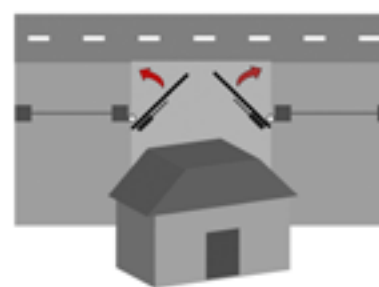

PUSH TO OPEN OPERATION (opens towards outside)

If your driveway slopes up after the gate, preventing it from swinging in. This means the gate operator is mounted on the inside of the property and pushes your gate out away from the property. Warning: only compatible with telescopic tube actuators, Check the overall dimensions before installation.

Warning:remember to reverse the polarity of the motor cables when connecting to the electronic board

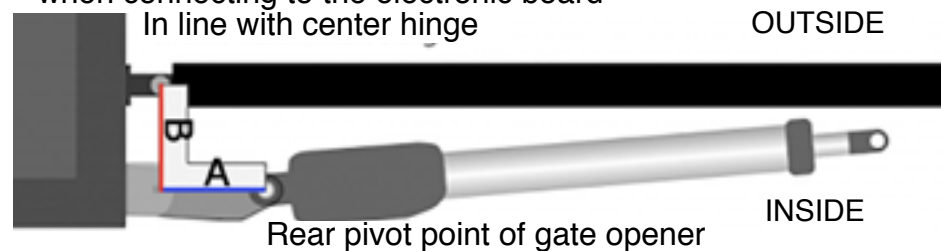

A = min. 8cm
B = min. 8cm max. 14cm

- EVE900 FC
 - EVE900 FCA (with on board open & closed position mechanical limits)
- each model is also available in 24V version

Maximal wing dimension:

Maximal wing lenght: up to 4m/ 14 ft
 Maximal wing weight: up to 450kg/ 1000lb

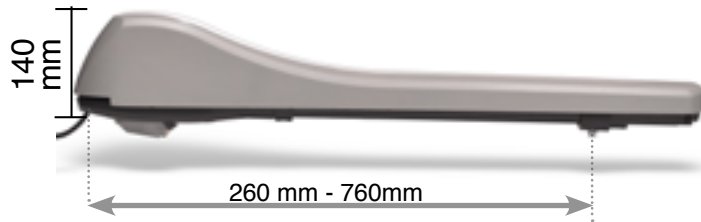

Multi-position fixing bracket:

choose the hole most suitable to your gate.

front fixing bracket

multiposition post fixing bracket

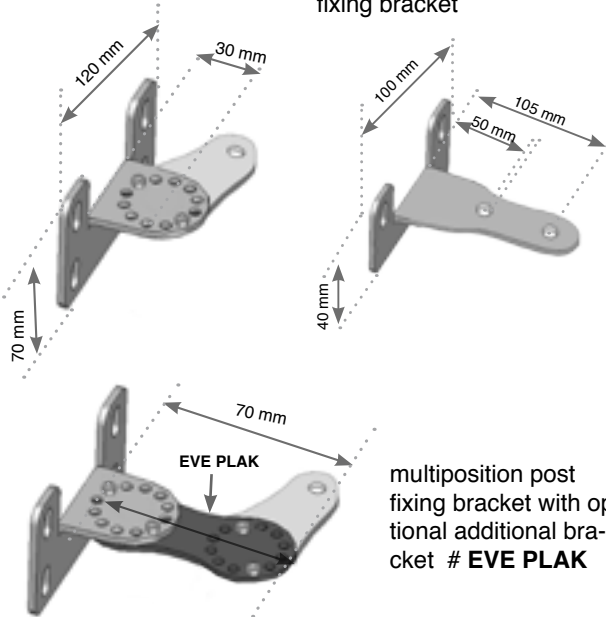

multiposition post fixing bracket with optional additional bracket # EVE PLAK

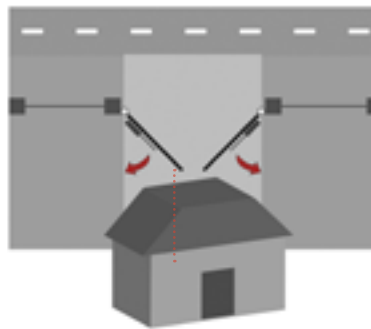

PULL TO OPEN OPERATION (opens towards inside)

This means the gate operator is mounted on the inside of the property and pulls your gate in towards the property to open.

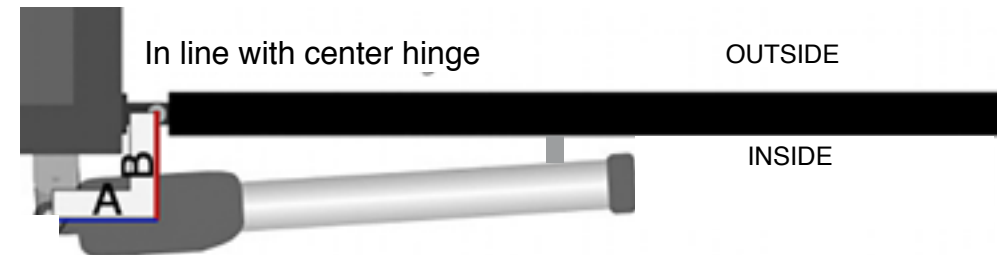

▣ Rear pivot point of gate opener

measures are in cm

METRIC CONVERSION

- 1 cm = 1/2" = 0,3"
- 10 cm = 4"
- 12 cm = 4 3/4" = 4,7"
- 14 cm = 5 1/2" = 5,5"
- 16 cm = 6 1/5" = 6,2"
- 18 cm = 7"
- 20 cm = 7 7/8" = 7,87"
- 25 cm = 9 3/4" = 9,8"
- 35cm = 13 4/5" = 13,7"

TAB	A-9	A-11	A-13	A-15	A-17	A-19	A-210	A-23	A-25
B-8	105°12sec	115°15sec	125°15sec	130°20sec	130°27sec	140°25sec	135°27sec	90°	105°
B-9	105°13sec	115°15sec	120°18sec	125°20sec	130°23sec	135°25sec	120°	90°	105°
B-12	100°14sec	110°17sec	115°19sec	120°21sec	120°23sec	125°26sec	120°	90°	105°
B-15	105°17sec	105°19sec	110°21sec	115°23sec	120°26sec	125°28sec	125°30sec		
B-18	100°18sec	105°20sec	110°23sec	115°25sec	115°27sec	120°29sec	100°28sec		
B-21	105°20sec	100°22sec	105°24sec	110°26sec	110°28sec				
B-25	95°23sec	100°25sec	105°27sec	110°29sec	110°31sec				
B-29	95°27sec	100°28sec	100°30sec	105°32sec					
B-33	95°30sec	95°32sec	90°32sec						
B-35	95°32sec	95°33sec							

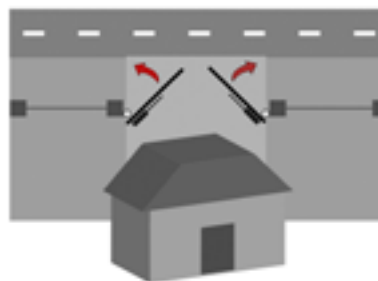

PUSH TO OPEN OPERATION (opens towards outside)

If your driveway slopes up after the gate, preventing it from swinging in. This means the gate operator is mounted on the inside of the property and pushes your gate out away from the property. Warning: only compatible with telescopic tube actuators, Check the overall dimensions before installation.

Warning:remember to reverse the polarity of the motor cables when connecting to the electronic board

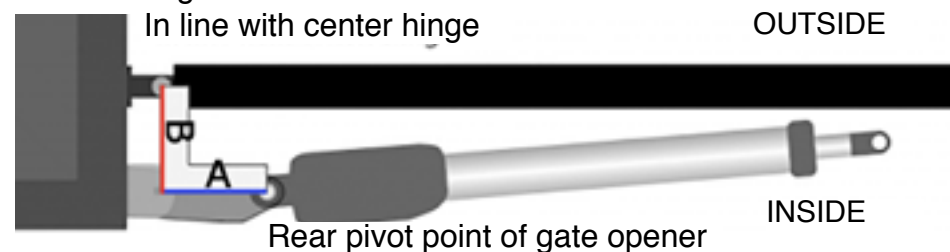

A = min. 8cm
 B = min. 8cm max. 14cm

DUCATI EVE 900T actuator's installation diagram

- EVE900 T FC
 - EVE900 T FCA (with on board open & closed position mechanical limits)
- each model is also available in 24V version



Maximal wing dimension:

Maximal wing lenght: up to 5m/ 16 ft

Maximal wing weight: up to 500kg/ 1100lb

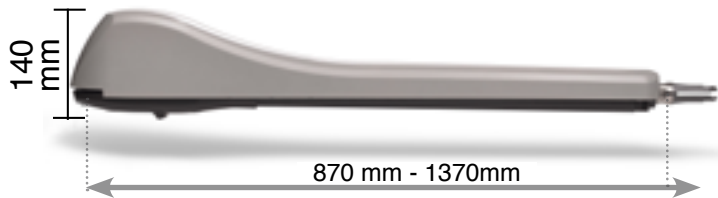

Multi-position fixing bracket:

choose the hole most suitable to your gate.

front fixing bracket

multiposition post fixing bracket

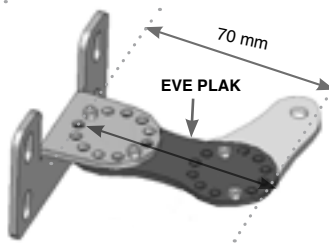
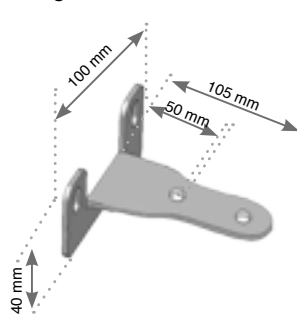
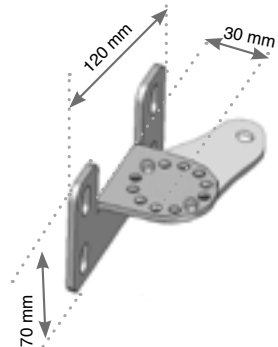

multiposition post fixing bracket with optional additional bracket
EVE PLAK

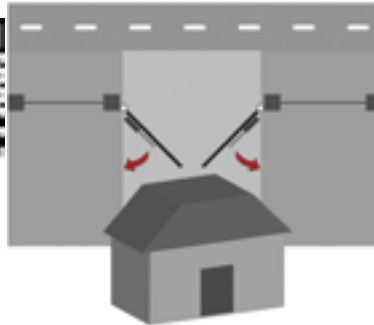

PULL TO OPEN OPERATION (opens towards inside)

This means the gate operator is mounted on the inside of the property and pulls your gate in towards the property to open.

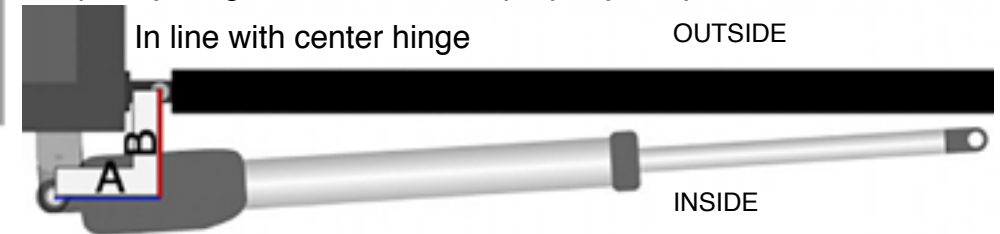

Rear pivot point of gate opener

measures are in cm

METRIC CONVERSION

- 1 cm = 1/2" = 0,3"
- 10 cm = 4"
- 12 cm = 4 3/4" = 4,7"
- 14 cm = 5 1/2" = 5,5"
- 16 cm = 6 1/5" = 6,2"
- 18 cm = 7"
- 20 cm = 7 7/8" = 7,87"
- 25 cm = 9 3/4" = 9,8"
- 35cm = 13 4/5" = 13,7"

TAB	A-9	A-11	A-13	A-15	A-17	A-19	A-21	A-23	A-25
B-9	105°21sec	115°22sec	120°23sec	120°23sec	125°23sec	130°25sec	135°26sec	135°26sec	120°23sec
B-11	105°21sec	115°22sec	115°22sec	115°22sec	120°23sec	125°23sec	130°25sec	90°18sec	115°22sec
B-13	100°20sec	105°21sec	110°21sec	115°22sec	115°22sec	120°23sec	125°23sec	125°23sec	105°21sec
B-15	105°17sec	105°19sec	110°21sec	115°23sec	120°26sec	125°28sec	125°30sec	125°23sec	105°21sec
B-18	100°18sec	105°20sec	110°23sec	115°25sec	115°27sec	120°29sec	100°28sec	105°21sec	100°20sec
B-21	105°20sec	100°22sec	105°24sec	110°26sec	110°28sec				
B-25	95°23sec	100°25sec	105°27sec	110°29sec	110°31sec				
B-29	95°27sec	100°28sec	100°30sec	105°32sec					
B-33	95°30sec	95°32sec	90°32sec						
B-35	95°32sec	95°33sec							

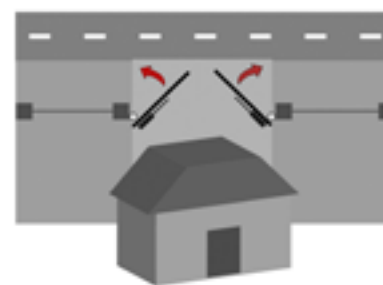

PUSH TO OPEN OPERATION (opens towards outside)

If your driveway slopes up after the gate, preventing it from swinging in. This means the gate operator is mounted on the inside of the property and pushes your gate out away from the property. Warning: only compatible with telescopic tube actuators, Check the overall dimensions before installation.

Warning:remember to reverse the polarity of the motor cables when connecting to the electronic board

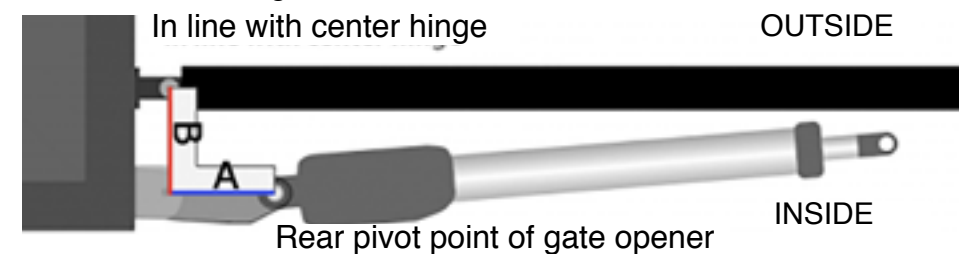

A = min. 8cm
B = min. 8cm max. 14cm

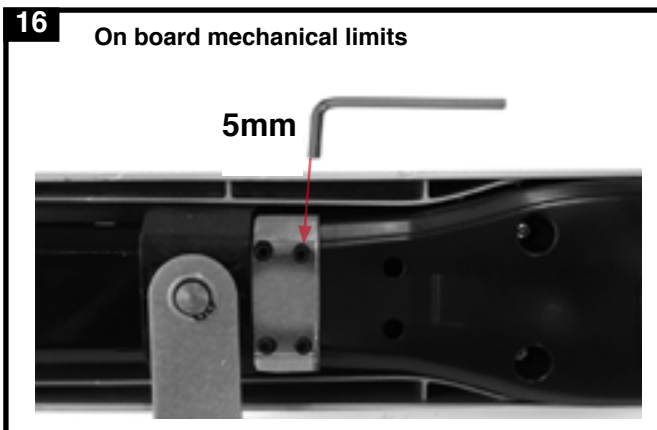
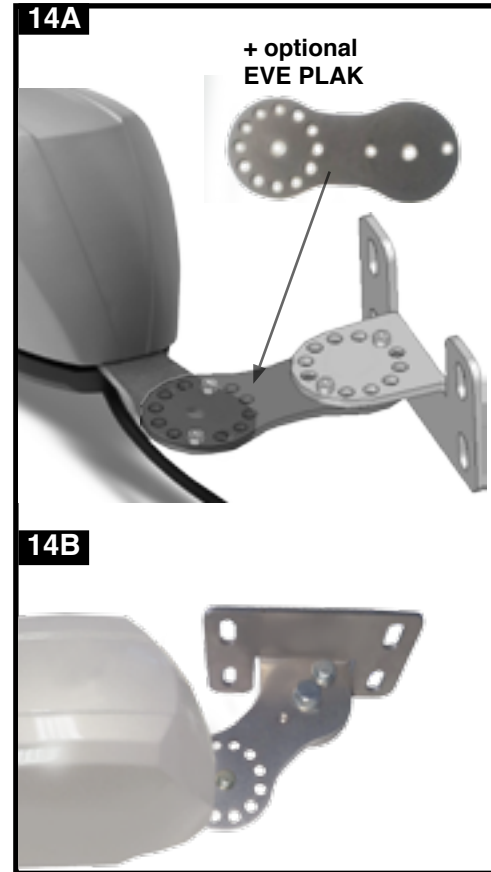
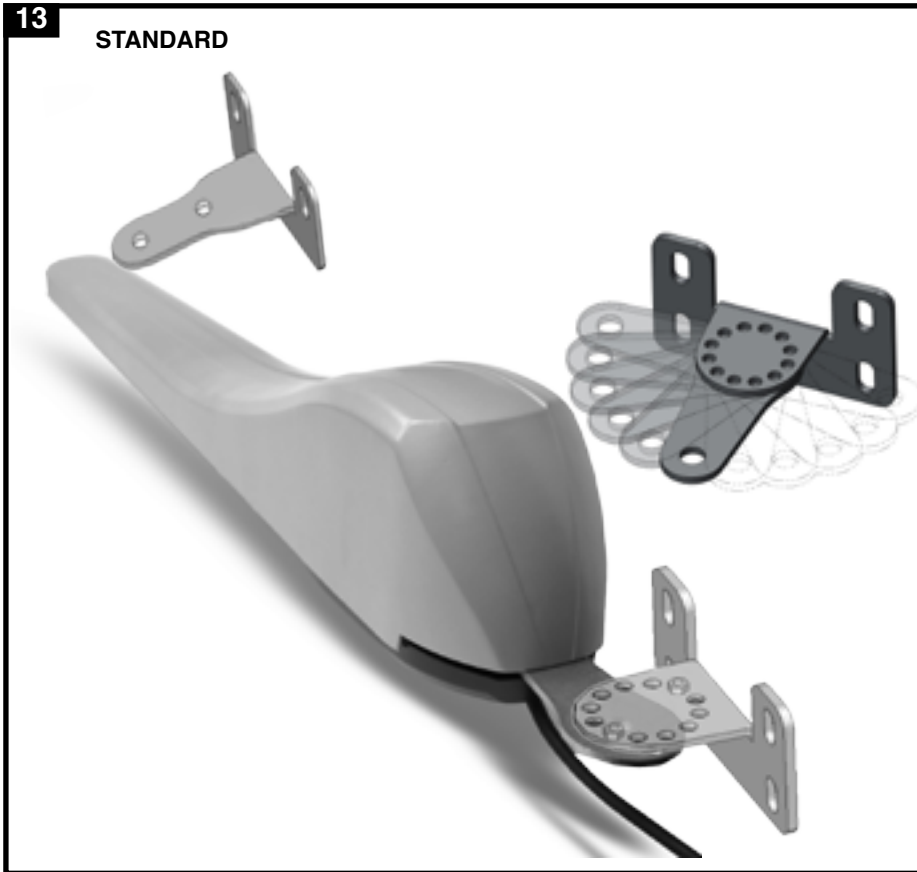

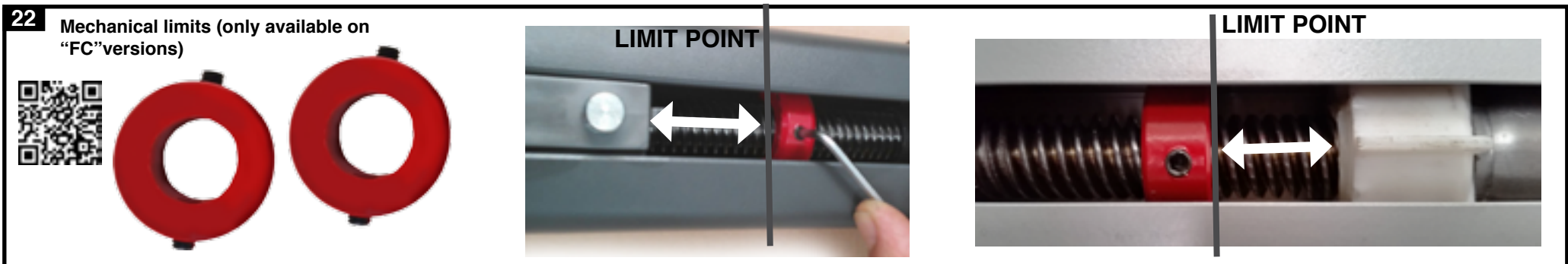
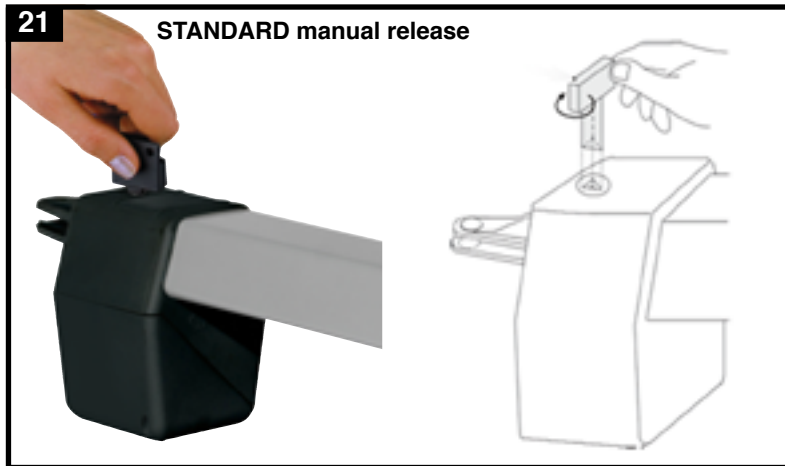
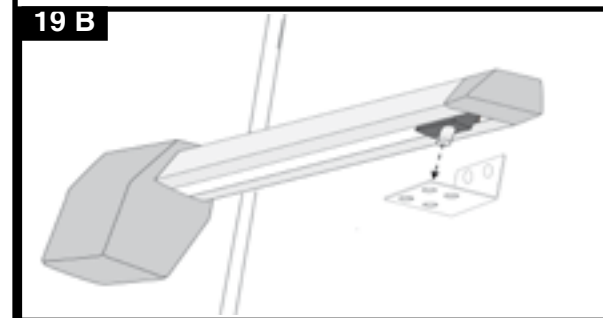
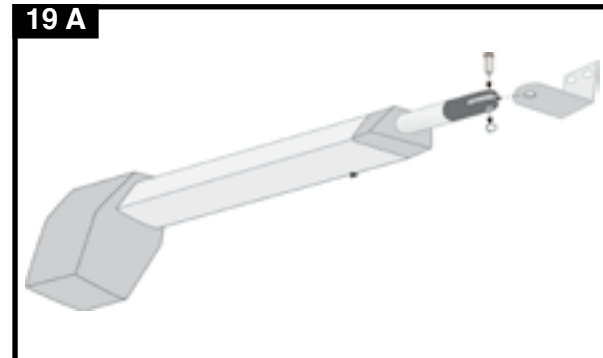
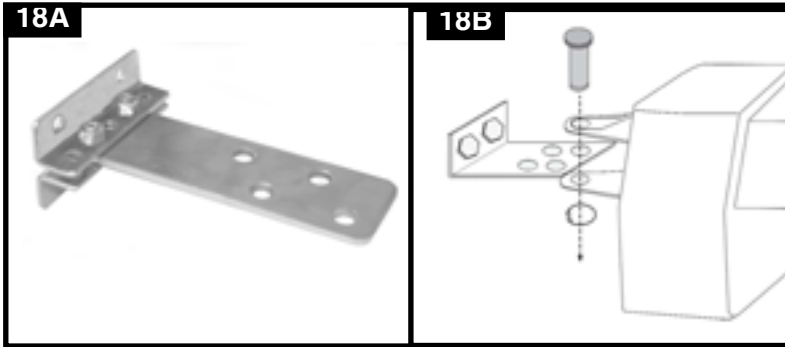

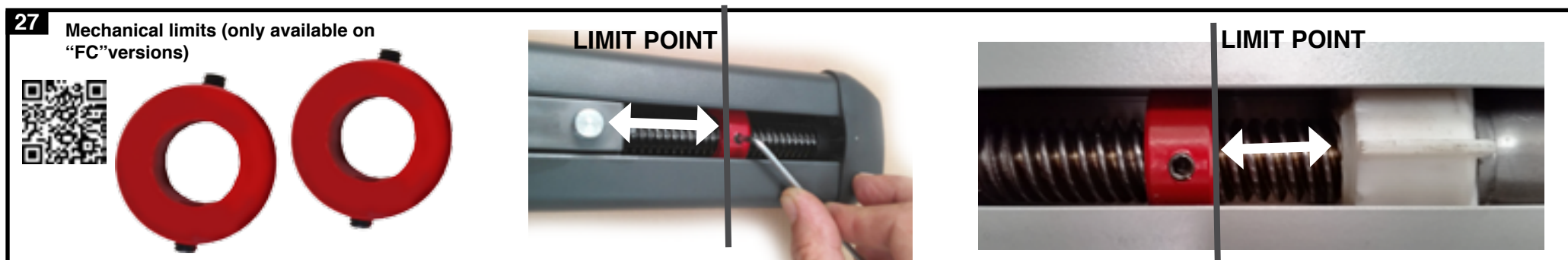
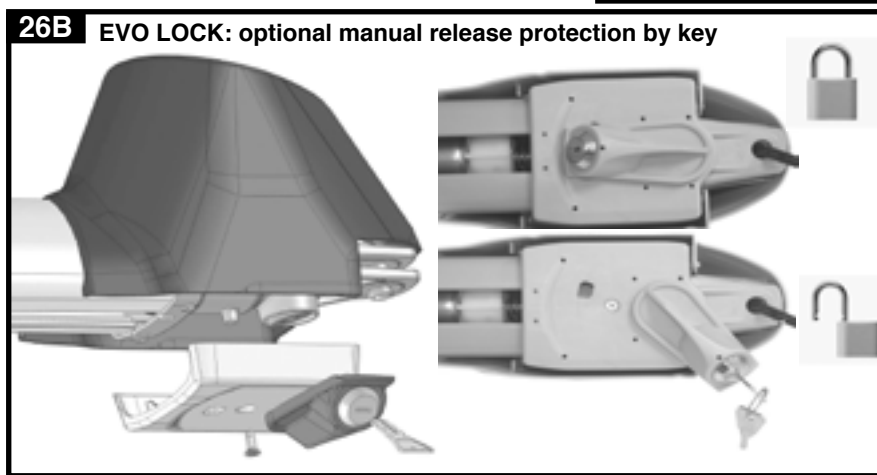
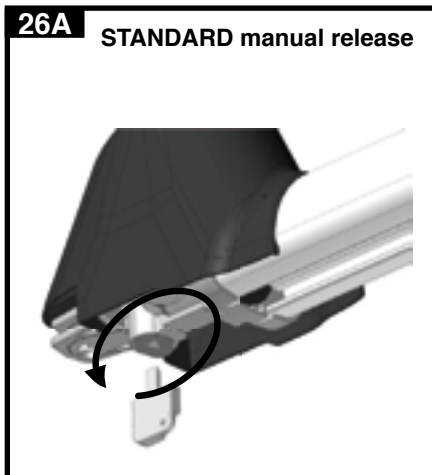
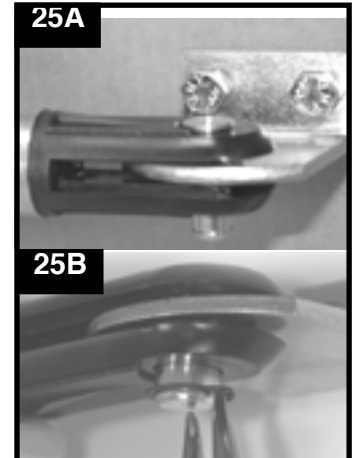
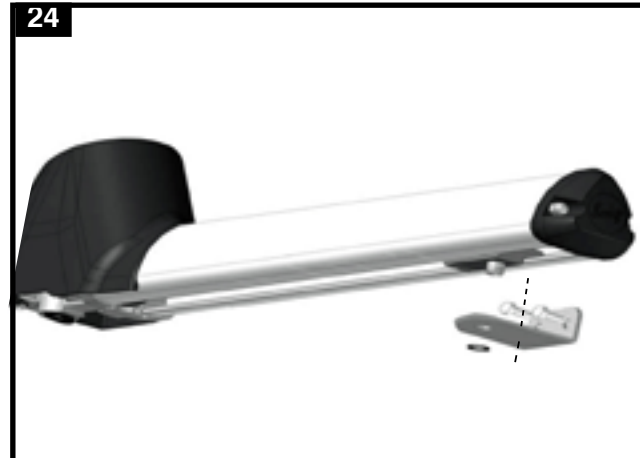
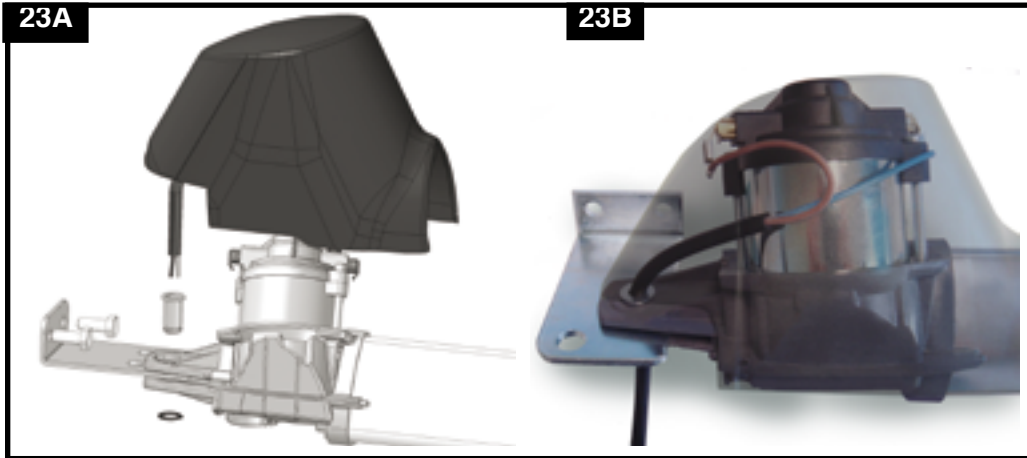

DUCATI Preliminary safety warnings and important informations

1. GENERAL CHARACTERISTICS and PRELIMINARY WARNINGS

The products described in this manual are intended to be used to automate hinged swing gates for residential/ commercial or industrial use, within the limits of use and size provided for each model.

Incorrect installation can cause serious injuries. **Before installing the automation you need to carefully read all the parts of the manual.** If in doubt, stop installation and request clarification from the DUCATI HOME Assistance Service.

 **WARNING!** the gate opener is just one of the components that once installed on the gate forms the automatic gate machine.

Make sure that the structure, that consists of pillars/ wall/ posts, hinges and gate, in perfect condition, perfectly installed, solid and robust. Check that the structure is compatible with the size of the automation and with the limits of use for the selected gate opener. Pay attention to correctly install each component of the gate opener.

 **A gate opener can not correct defects or structural problems of the gate** or other component of the structure. If the installation is not carried out correctly, it is not possible to guarantee the proper functioning of the automatic gate system, neither respect of safety norms.

We recommend installation anti-fall cables to prevent accidents caused by the physical fall of the gate.

The structure on which you are installing must be constructed in a workmanlike manner in accordance with local regulations and satisfy all safety requirements. The automation can not correct defects in the structure. Check that the gate leaves are perfectly balanced, that the hinges are in perfect condition and that the facility is fully operational and complies with safety regulations. Gates with structural problems should not be automated **Warning:** Ducati actuators are designed to be installed to be used indifferently on the right or left leaf of the gate.

 **WARNING!** Any use other than those described in this manual is to be considered improper and prohibited!

Ducati's electromechanical actuators are provided with DC motor, worm screw gear. The motor must be run by a compatible original "DUCATI HOME automation" control unit only.

The actuator stops its movement by means of an amperometric detection system as the gate wing reach a mechanical end stop fixed on the ground to set the open and closed position limit of each wing (only special FC version actuators are provided with on board mechanical end limit).

In case of obstacle detection, safety is also ensured by the amperometric detection system in compliance with EN laws.

In case of power failure (black-out), the actuators are provided with a manual release system by trilobed key.

Warning: to operate the manual release system is required to operate on the actuator witch is installed inside the property, it is therefore advisable to provide an independent pedestrian entrance.

Pages 4-5: The table shows the compositions of each kit, including the corresponding actuator model and control board model.

Page 6: the table shows the technical characteristics and application limits of each actuator model.

Page 7: the table shows the characteristics and comparison of each Control Box (electronic board).

Page 8-9: shows the general installation diagram as well as important information about the requirements of the structure

Pages 10-22 shows each single actuator model installation diagram, limits and overall dimension.

 **IMPORTANT:** Before proceeding with installation carefully read the following preliminary warnings

2. SAFETY WARNINGS

 **Warning ! READ AND FOLLOW ALL INSTRUCTIONS** contained in this installation and use manual. DUCATI gate openers have been designed and tested to offer safe service at condition they are correctly installed, operated, maintained and tested in strict accordance with the instructions and warnings contained in this manual. Failure to meet the requirements stated in this instruction manual could cause severe injury and/or death, for which the manufacturer cannot be held responsible.



SAVE THIS INSTRUCTION MANUAL

Make sure everyone who's using or will be using the gate door opening system is aware of the dangers associated with this system. In case you will sell the property with the gate opener, Provided for copy of this manual to the new owner.



WARNINGS:

- Before starting the installation, check whether the product is suitable to automate your gate, If it is not suitable, DO NOT proceed with the installation.

Before installation:

Understand your new gate opener

- Read this instruction manual in advance to thoroughly understand its function and features.
- Verify that this gate opening system is proper for the type, size and weight of your gate.
- Check the state of your gate & pillars/ posts :
- Make sure that your gate has been properly installed and is functional.
- make sure the gate and post must be suitable for being automated.
- Check that the structure is sufficiently strong and rigid, and its dimensions and weights conform to the limits of the purchased gate opener.
- Make sure the leaves move smoothly without any irregular friction during entire travel.
- Make sure your gate is properly balanced and lubricated. An unbalanced gate could cause serious injury or death! Make sure the gate is plumb and level.
- The post must be secured in the ground with concrete. This will prevent alteration of alignments and leveling during installation and during cycles
- If the gate binds, sticks or is out of balance, before proceeding with gate opener installation, call a trained, certified gate technician to correct it and prevent serious injury or death.
- Repair or replace all worn or damaged gate components prior to installation. Call a trained professional gate technician for this.
- Make sure the hinges are in good condition. Ball bearing hinges are ideal for gates wings.
- To prevent damage to the gate and opening system, always disable the manual locks before installing and operating the opening system.

Prevent serious injury or death by electric power:

- Be sure the power is not connected BEFORE installing the gate opener control box
- NEVER connect the gate opener to the power source until instructed to do so.
- The gate opener installation and wiring MUST be in compliance with all local electrical and building codes

During installation

Ensure your personal safety:

- Never wear watches, rings or loose clothing while installing or servicing the opening system. They could get caught in the gate opener mechanisms.

- High voltage wiring (110V-230V power) must be done exclusively by a competent professional and certified electrician.

Prevent serious injury or death:

- Be careful when manipulating with moving parts and avoid close proximity to areas where fingers or hands could be pinched.
 - Use concrete anchors when installing any brackets into masonry.
 - Do not activate your gate opening system unless you are sure that the area of its travel is clear of persons, pets or other obstructions.
Watch the gate through its entire movement. Never leave childrens without parental control in proximity of a gate opener in motion, opened, closed or stopped.
 - Never permit children to play with remote control push buttons or transmitters of gate opener and prevent childrens to operate the gate opener by control push buttons or transmitters.
 - Always keep remote controls out of reach of children.
 - Install the electronic box of your opener out of reach of children and away of moving parts of the gate.
 - Activate the gate opener only when the gate can be seen clearly, is properly adjusted and there are no obstructions to gate travel.
 - Always keep gate in sight until completely closed.
- Prevent damage of the opening system and reduction of its safety features:
- The motor fixing brackets must be rigidly fastened to the pillar/wall/post and to a well reinforced part of the gate.
 - Never increase force beyond minimum amount required to close the gate.
 - Never use force adjustment to compensate for a binding or sticking gate.
- After any adjustment is made, the safety system must be tested.

After installation

- Install any fixed control at height of at least 1,5m and within sight of the gate but away from moving parts
 - Make sure you have a second pedestrian access to your property.
- Remember: in case of power failure or any problem with your opener you might be unable to operate it from outside your property
- Save the unlocking key in a safe place out of reach of childrens, in order to permit to manually unlock (from inside) the gate and operate it manually in case of power failure or other problem.

Verify correct installation:

- Ensure that the parts of the door do not extend over public footpath or roads
- Upon completion of installation, unlock the actuators and manually open and close the gate to check there's no mechanical friction and that it works correctly

DUCATI

How to install the actuator

- Make sure the gate wings stops on mechanical end limit fixed on the floor (not mandatory for FC actuators where mechanical limit stops is provided on board)
- SAFETY System in compliance with EU norms:
EN 12453 ENSURE SAFETY AND PREVENT ENTRAPMENT- CRUSHING
Any gate or garage door opener is required by the European Union to attend a series of strict and restrictive mandatory regulations which clearly regulate the automation industry.
Any new or existing installation requires a declaration of conformity issued by the manufacturer.
DUCATI not only self-certify his products, but also mandated International Notify body laboratories to perform full tests to certificate the compliance of the products to all applicables EN norms.
DUCATI ensure that the forces generated by a correctly installed gate opener, when touching a person or an obstacle are limited and that they do not exceed the values specified in Annex A of BS EN 12453:2001.

The final machine to be tested is composed by 2 fundamental elements: the structure (gate or garage door) and the automation device. This 2 elements compose the machine: automated electric gate/ automated electric gate system. Any new or existing installation requires a declaration of conformity issued by the final installer. The installer must test the final machine and attest the compliance to the latest European standards concerning impact forces in case of obstacle detection. Tests must be performed with a dinamoteter in precisely specified positions

Ensure safety and prevent injuries:

- Place warning sign of automated gate on the gate or next to it. Permanently fix a label warning against entrapment in a prominent place or just near any fixed control
- Without a properly working safety system, people (particularly small children) can be SERIOUSLY INJURED or KILLED by a closing door. After installation ensure that the mechanism is properly adjusted.
- Never permit anyone to cross the path of a closing gate.
- No one should go close to a stopped, partially open gate.
- Never leave children unsupervised near a gate opener, whether moving, open, closed or stopped.
- Never permit children to play with the gate opener's remote control buttons or transmitters, and do not allow children to use them to operate the gate opener.
Always keep remote controls out of reach of children.
- Install wall-mounted gate controls out of the reach of children and away from moving parts of the gate.
- Always keep the gate in sight until completely closed.

- While the gate is closing, do not attempt to stop it by hand. This is extremely dangerous.

MOUNTING HARDWARE:

To complete the installation you need at least following material:

- plastic hammer;
 - pinching for Seeger;
 - level;
 - frame fixing;
 - Cross screwdriver PH2;
 - flat screwdriver 2,5 mm;
 - adjustable wrench;
 - outdoor electric cable (2 poles) H07NRF length according to the connection of the two actuators to the control box;
 - 4 bolts for fixing plates with the gate with a diameter 8 mm length according to the thickness of the-gate;
 - 4 bolts for fixing plates with the pillar with a diameter 8 mm length according to the thickness of the pillar; pinching;
 - vice;
 - cable clamp.
 - Outdoor electric cables for additional accessories connections (0,5mmq)
- Prepare all the tools and material of use necessary to the installation.
Tools must be in perfect state and in conformity with the safety rules indicated by the national law.
Prepare and install an insulated underground ICT25 mm sheath to pass the actuator cable (2x1 mmq) to the control box as well as the photocells cables.

How to install the actuators

3. General installation diagram

The diagram on page 8 shows an example of a typical automatic system. Referring to this diagram, determine the approximate location where you will install each component envisaged in the system and the most appropriate connection diagram.

The actuators should preferably be installed at a height between the two gate hinges, and always in line with a reinforced horizontal cross of the gate to fix them in a structurally strong point. In case the gate is not provided with a reinforced horizontal cross, the gate structure must be reinforced at the actuator fixing point
The actuator should anyway never be installed less than 15 cm from the ground

The control unit box must be placed outside the reach of children and unauthorized persons, (at a suggested high of min. 1,2 m from the ground) preferably with a minimum distance of 60 cm from the actuators. If the control unit is not installed next to the gate but remotely, for example in a control room, an external radio receiver must be added to the system, which receives the radio signal in proximity of the gate.

The actuators must be connected to the main electronic board by a outdoor use bipolar electric cable H07NRF min 1 mmq.

The accessories must be connected with an outdoor use min. 0.5 mmq electric cable. (Cables, screws and dowels on the structure are not provided, but must be purchased separately according to the system and the specific material and dimension of the structure).

Automatic gate opener essential components

The minimum components needed to automate a swing gate are:

- 1= Control box with containing electronic board with on board radio receiver, toroidal transformer, inner battery compartment.
- 2 = actuators
- 3 = blinking light
- 6 = radio remote control

Useful additional components to complete the automatic gate system:



- 4 = external antenna
- 5 = key switch
- 7 = radio keypad
- 8 = solar panel
- 9 = pair of photocells (receiver + transmitter) & pair of photocells integrated in columns
- + GSM module and /or GSM Intercom to command your gate opener by your mobilephone

Gate opening towards inside (pull to open) or outside the property (push to open)

CAUTION: the most common types of gates are those with opening to the inside of the property. It is however also possible to automate gates that open out of the property following the following warnings:
to automate a gates that opens towards inside the property, it is necessary to use a compatible actuator model (telescopic actuators are recommended). check the

specific actuator diagram (page10-22) to verify it is compatible for installation on gate that opens towards outside.

NOTE: in the case of gate opening to the outside (PUSH-TO-OPEN) , it is necessary to reverse the polarity of motor cable wiring (check electronic wiring diagram of your electronic board model (page 36-52)
Check the feasibility of such a system considering the lateral overall dimensions. Make sure the gate wings do not open on a public passageway (This may be prohibited by specific national or local law, and you may be held liable for damages or injuries caused to third-party)
It is advisable to equip the system with a safety light barrier (photocells), which should be positioned so that the wings do not cause any damage or disturbance to any passing pedestrians, bikes or parked vehicles.

4. HOW TO INSTALL THE ACTUATOR:

The actuators must be installed inside your property.
First of all you should determine the height at which the actuators will be positioned. They should be preferably installed at a height between the two hinges, remember they must always match a reinforced horizontal cross of the gate to ensure the actuator is installed in a resistant part of the structure of your gate.

Warning: the actuator should never be installed less than 15 cm from the ground

Warning: the actuators must be installed horizontally in line with the gate: Check with a spirit level that the gate is perfectly balanced and make sure the drive is in balance with the gate. Take into account that if the actuator is not installed in line with the gate, it may cause a point of major friction during travel, incorrect operation and damages.

Identify the exact model of the actuator delivered in your gate opener package kit (see table page 4-5) and verify that the installation limits and the maximum A and B measures your structure must comply to be compatible with your actuator that your actuator are respected.

4.1 – Post mounting bracket

Pillar/ Column/ fence post: determinate the position where to install the post mounting bracket

According to the actuator model, and to the pillar/wall dimension, calculate the ideal fixing position of the rear bracket by consulting the installation schema of your

DUCATI How to install the actuator

actuator's model see diagram on page

HC 312.....	page 10
HC 412.....	page 11
HC 512.....	page 12
HC 612.....	page 13
HC 418.....	page 14
HC 518.....	page 15
HC 618.....	page 16
SW 400.....	page 17
SW 400T.....	page 18
EVO 700.....	page 19
EVO 700T.....	page 20
EVE 900.....	page 21
EVE 900 T.....	page 22

VERY IMPORTANT ADVICES:

 **WARNING:** The actuator should preferably have a **angle of incidence** to the closed gate and therefore not be perfectly parallel to the gate wing (see page 8). This will keep your gate well locked when the gate is closed, as the actuator will push the gate wing to the end stop with major force.

 **WARNING:** make sure **not to use the full actuator stroke** as the gate wing must stop by pressing on a mechanical end limit (fixed on the ground or FC integrated limit) before the actuator reaches the end of its own stroke travel (see page 8). In case of telescopic actuator it allows to keep the telescopic tube more guided when it is extroflexed, ensuring greater solidity.

 **WARNING:** In Gate opening towards inside the property (PULL-TO-OPEN) measures A & B shown in each actuator's diagram as well on page 9 are extremely important as they shall determinate the gate opening angle and speed as well as actuator thrust strenght. The shorter travel of the actuator's stroke is used, the greater the gate opening speed will be.

In general, smaller the A and B measurements, will result in higher gate opening speed.

Attention, it is recommended not to use a too high opening speed to avoid unwanted bumping rebounds at the end of the maneuver.

 **Where possible increase measure B to reduce speed.** Important! to allow a linear movement of the automation A & B measures should be similar.

Warning: on double wing gates use same A & B measure on both sides.

To determine the most suitable mounting position, proceed as follows:

- Measure the depth of the the Post/ pillar column where your gate is installed to (measure from the center hinge to the inner edge of the column)
- After the depth of your post has been measured, compare it to maximal dimensions A and B indicated in the table of your actuator's model.

Warning: "B" measure is the sum of the depth of your pillar to center hinge + length of fixing brackets supplied.

Warning: the supplied post fixing brackets offer several holes choice.

- Select the hole where to fix the actuator to, accordingly to A & B measures limits.
- If necessary, cut away the excess of the bracket.

Warning: in some cases it will be necessary to get tailor-made post fixing brackets made by a blacksmith (for example in the case of round columns).

- Now determine the mounting position of the plate on the column, taking into account that the dimension B determines the maximum opening angle and the door opening speed. If this angle does not match your needs, you should re-adjust quote A and quote B so that they are similar.

Warning: Before securing the rear bracket and keeping the actuator in a perfectly horizontal and balanced position, perfectly horizontal supporting the engine, verify that the front fixing point of the actuator coincides with a solid and robust cross of the gate. Make sure that the actuator is mounted at a minimum height above the ground (min.15 cm are recommended) so that it is easy to operate the manual unlocking system.

Warning: in case your structure dimension do not allow to comply with the A& B dimensions stated in the actuator table & diagram (ex. large masonry pillar), you will need to carry out masonry works to allow the correct installation of the gate opener

Fix the bracket to the pillar/ coloumn/ fence post

Each actuator model is provided with specific fixing brackets.

Mark middle of post bracket slots on pillar/ coloumn/ fence post.

Fix the bracket on the pillar. Use suitable fastening bolts anchors (not supplied) suitable to the pillar construction material (iron post / concrete, brick or stone pillar).

Fix the actuator to the post bracket:

Fasten the actuator to the bracket of the rear fixing with the pin and seal ring

- for EVE actuators see pag..23
- for "HC" actuators see pag.24
- for "SW" & EVO actuators see pag.25

4.2 Front mounting bracket: How to determinate the position where to install the front mounting bracket

 **Warning:** make sure **not to use the full actuator stroke** (save at least 1-2cm of travel) as the gate wing must stop by pressing on a mechanical end limit (fixed on the ground or FC integrated limit) before the actuator reaches the end of it's own stroke travel (see page 8).
In case of telescopic actuator this allows to keep the telescopic tube more guided when it is extroflexed, ensuring greater solidity.

Suggestion: if it is necessary to move the actuator forward or backward, the motor can be powered directly with a 12V battery: connect the motor's two-pole cable to the two poles of the 12V battery. By inverting the polarity the motor reverses the direction of travel

Warning:

 **A) TELESCOPIC ACTUATORS,** featuring telescopic stainless steel telescopic tube are supplied with totally retracted piston tube, therefore the fixing position of the front bracket to the gate must be determined **with the gate in open position* (in case of gate opening towards inside the property)** or Vice versa in the case of a gate that opens outwards (push-to-open).

Resume of telescopic actuators models:
HC312; HC412; HC512; HC612; SW400T; EVO900T; EVE900T (+ corresponding 24V versions)

 **B) NOT TELESCOPIC ACTUATORS** are provided with running sleigh (sliding shoe plate) positioned to the front of the actuator, therefore the fixing position of the front bracket to the gate must be determined **with the gate in closed position* (in case of gate opening towards inside the property)** or Vice versa in the case of a gate that opens outwards (push-to-open).

Resume of NON telescopic actuators models:
HC418; HC518,HC618, SW400; EVO900; EVE900 (+ corresponding 24V versions)

Fix the front bracket to the gate

- The actuator must be fastened to the front fixing bracket, keep it perfectly in line with the gate wing

- bring the actuator to the gate leaf and identify the fixing point of the front plate to the wing gate.

- Mark middle of front bracket slots on the gate wing.

- Fix the bracket on the gate. Use bolts anchors or screws suitable for the gate (wood/ iron/...). It 'also possible to weld the bracket to the wing of the gate.

- Fasten the actuator to the bracket. Fix it with the pin and seal ring

- for "EVE actuators see page 23

- for telescopic "HC" actuators see page 24 drawing 19A

- for non- telescopic "HC" actuators see page 24 drawing 19B

- for telescopic "SW" and "EVO" actuators see page 25 drawing 25

- for non-telescopic "SW" and "EVO" actuators see page 25 drawing 24a/b

5. MANUAL RELEASE

The actuators are equipped with a release system which allows the manual handling of the gate in case of emergency.

The release system is operated through the use of three-sided key that must be inserted into the triangular slot.

Turn of about 180 ° up to the stop in a counterclockwise direction.

The actuators will be unlocked and the gate can be opened manually.

The reverse operation will restore the automatism traction.

Warning! perform the manual release only once the actuator is installed to the gate. The manual release could be little bit hard in the beginning, but after a run-in period will be smooth

- for EVE actuators see page 23

- for "HC" actuators see page 24

- for "SW" & EVO actuators see page 25

For "EVE" actuators the optional "EVE LOCK" manual release key protected accessory is also available. see page 23 fig. 15B

For "SW & EVO" actuators the optional "SW LOCK" manual release key protected accessory is also available. see page 25 fig.26B

In order to have access to the release system from the outside, it is advisable to create a secondary pedestrian passage, especially in the case where the gate does not allow access from the outside to the system.

6. Control maneuver.

Test of correct mechanical installation of the actuators on the gate

After installing the actuators, unlock them and perform some control maneuvers by manually moving the gate leaves. Make sure that the movement is smooth and continuous without any point of friction.

7 - MECHANICAL LIMITS

NOTE: the actuator will stop by amperometric detection system: it therefore requires mechanical stop limits to be installed on the floor to stop the gate wing in the open and closed position.

It is reminded that, with exemption in case of use of actuators featured with integrated mechanical or electrical limits, **it is mandatory to install mechanical gate stop limits to be firmly placed to the ground in correspondance to gate closed and open position (see page 4).**

The gate opener stops running by amperometric detection when the door detects and presses on the mechanical end limit.

FC actuator versions are equipped with integrated mechanical limits. for FC actuator versions, where the on-board limit is provided, it is not mandatory to have gate stops fixed to the ground.

- All actuators of the “**EVE**” series have a double mechanical end limits for “open” and “closed” gate position (see page 23 Fig. 16)
- SW, EVO and HC series actuators can be supplied in the special “FC” versions with integrated mechanical limit/ limits

WARNING:

HC; SW; EVO non telescopic actuators in FC version can be supplied with up to 2 integrated mechanical limit to set both open and closed gate position.

HC; SW; EVO telescopic actuators in FC version can be supplied with only one integrated mechanical limit.

For those actuators the integrated limit will set:

- the gate open position in case of gate opening toward inside (pull-to-open)
- the gate closed position in case of gate opening toward outside (push-to-open)

HOW TO ADJUST THE INTEGRATED END LIMIT (FC VERSIONS ONLY)

- #### 7.1 on board mechanical limits adjustment (for FC actuator’s versions only)
- Release the actuator
 - Manually place the gate wing in the open desired position. Hold the gate in the desired position.
 - Loosen the on-board mechanical stop ring’s screw with an Allen key
 - Slide the on-board mechanical stop ring along the large screw until it goes into contact with the nut screw (or sliding shoe plate)
 - stop & firmly tighten the limit switch by fastening the grains using an Allen key.
 - you can repeat the same procedure to adjust the second limit (if supplied) and set it for the gate leaf closed position.

7.2 on board electric limits adjustment (for EVE series in the “FCA” versions only)

Models: EVE in the “FCA” versions are equipped with 2 electric limits. To adjust the position of the limit switches use a flat screwdriver through the holes positioned in the front of the actuator. By turning the screws, you will adjust the electric limit along the stroke of the rod. The limits position is indicated on the side of the actuator by special marker

8. SAFETY AND END TEST

The manufacturer warrants that the gate openers, if correctly installed, and in accordance with the instructions manual, comply with the maximum obstacle thrust parameters specified in the European Standard EN 12445 ; EN 12453; EN 12635 and EN 13241-1.(Product’s compliance to the EU norms have been tested and certified by notify bodies such as Nemko and INTERTEK),

The installer of the gate opener to the gate is required to test the final machine to be in compliance with EU norms by using a dynamometer. The installer is required to issue the corresponding test certificate to the final user. Attention: the European Machinery Directive refers to the final structure and not to the gate opener only. Please note that the system consists of the gate opener (actuators+ kontrol board + accessories) + the structure on which the gate opener is installed on (gate-hinges, pillar/post/end limit). Each automated gate is therefore a unique machine and must therefore be tested and certified to be in compliance with EU or other national norms.

9. MAINTENANCE

The drives do not require any special maintenance. As a precaution and during intensive use, it is best to check the integrity of the electrical cable on the motor. Over time, it may be necessary to replace the carbon brushes (R15).

WARNING: NEVER USE GREASE LUBRICATE THE MECHANICAL PARTS!

10. PREDISPOSITIONS

Prepare the insulated cable ducts for motors and accessories wires (not supplied). Prepare the power plant to the location where you intend to attach the control unit (not necessary in the case of self-powered SOLAR PANEL powered openers) Warning: the power of the high-voltage current must be managed exclusively by a specialized technician. Do not manage yourself the power supply connection 230 / 110V: Danger of Death!

Caution: it is recommended to prepare a disconnection device to be used in case of emergency. Warning: the control unit and activation commands must be installed in a not accessible place and at a height from the ground, not allowing the use by unauthorized persons or children.

11. CONTROL BOX INSTALLATION

Fix the bottom of the control unit to the wall or pillar using appropriate screws and plugs (not supplied).

It is advisable to seal any holes to prevent water infiltration, moisture, dust and insects.

It is recommended to provide appropriate compression sleeves (not supplied)

Small control box KONTROL” Small” see pic.39

Large control box KONTROL”Large” see pic.40

The control Kontrol “Large” is equipped with a inner protective cover underneath which are inserted the electronic board and the toroidal transformer.

39

DUCATI Kontrol “small”

Control Box

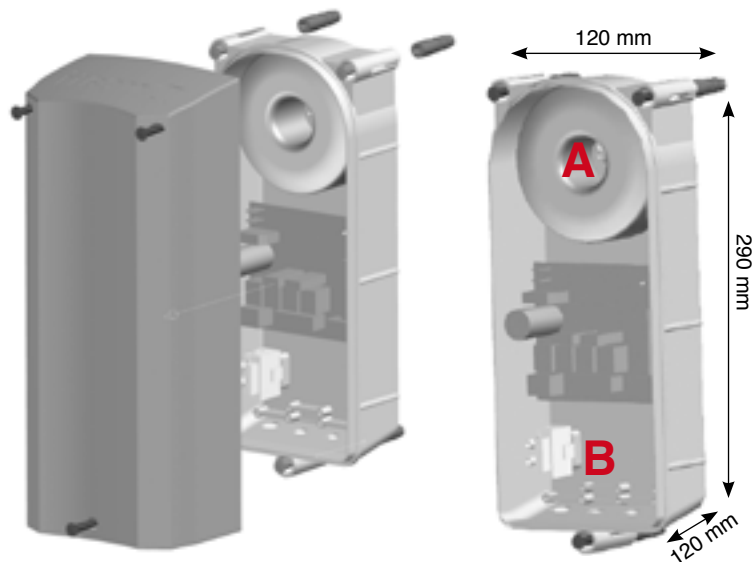

40

DUCATI Kontrol “large”

Control Box

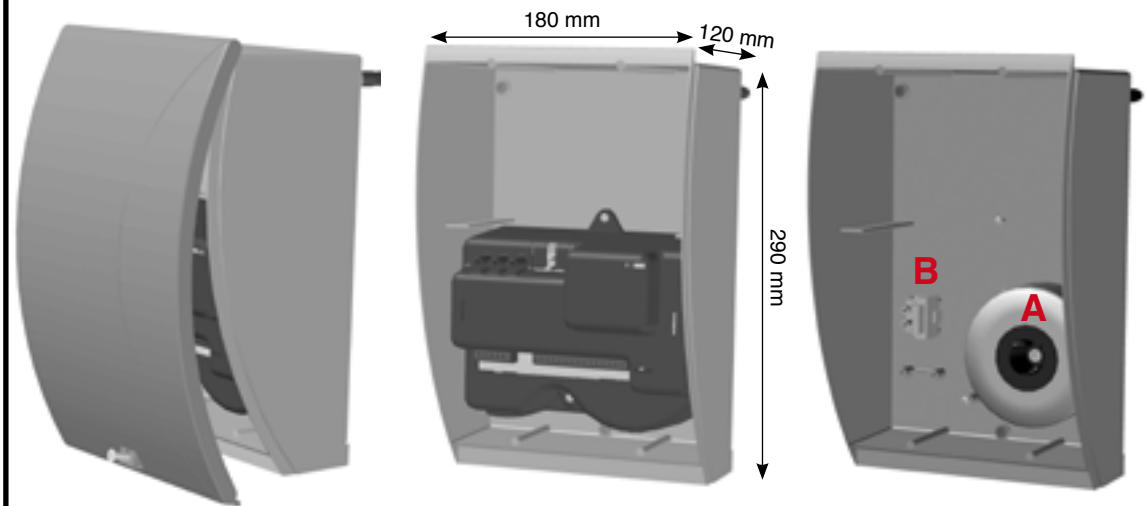

DUCATI Main AC power supply wiring

12. MAIN POWER SUPPLY 230V / 110 V

The main power supply high voltage 230V (110V on request) connection must be performed only by a licensed electrician! Warning: danger of death.
The power cable is connected to the terminal block / fuse protection upstream of the toroidal transformer (pic.41)
The transformer is already connected to the PCB. Check for proper connection.
Connect cables from the transformer to the circuit board.

The toroidal transformer has 3 output cables,
Black =0 + Yellow= 12V to be used for 12V electronic boards and motors
Black =0 + Red= 24V to be used for 24V electronic boards and motors

Solar panel powered openers do not require any high voltage connection .Nevertheless, they are always provided with a toroidal transformer and in case of emergency or to recharge the battery the main voltage 230V (110V on demand)can be connected to the terminal block / fuse protection upstream of the toroidal transformer (pic.41)

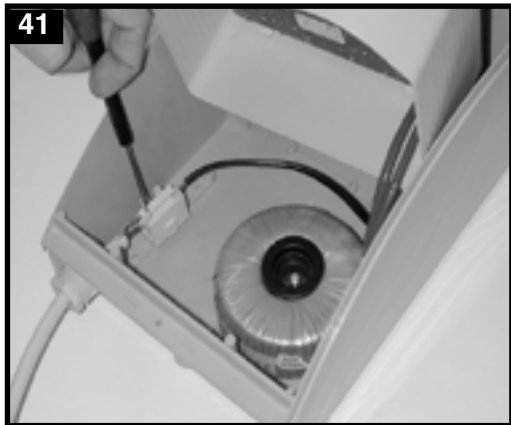

WARNING! To prevent damage during shipment, the transformer could be provided not pre-installed in the control panel. it is supplied with a fixing cone and screw to fix it to the bottom of the the control box.

See pic. 39/ 40: Place the transformer in it's correct position (A) and fix it to the bottom of the control box unit using using the special cone support and crew it.

Fix the power supply 230V / 110V connectors terminals with protection fuse in the position (B) of the bottom of the control bozx unit (see pic. 39-40).

Connect cables from the transformer to the circuit board. Remember:
The transformer has 3 ouput cables, but for 12V motors only balck and yellow cable must be connected. while red cable (24V must be used in stead of yellow cable only for 24V motor versions)
Black =0 + Yellow (could be orange)= 12V to be used for 12V motors
Black =0 + Red= 24V to be used for 24V motors

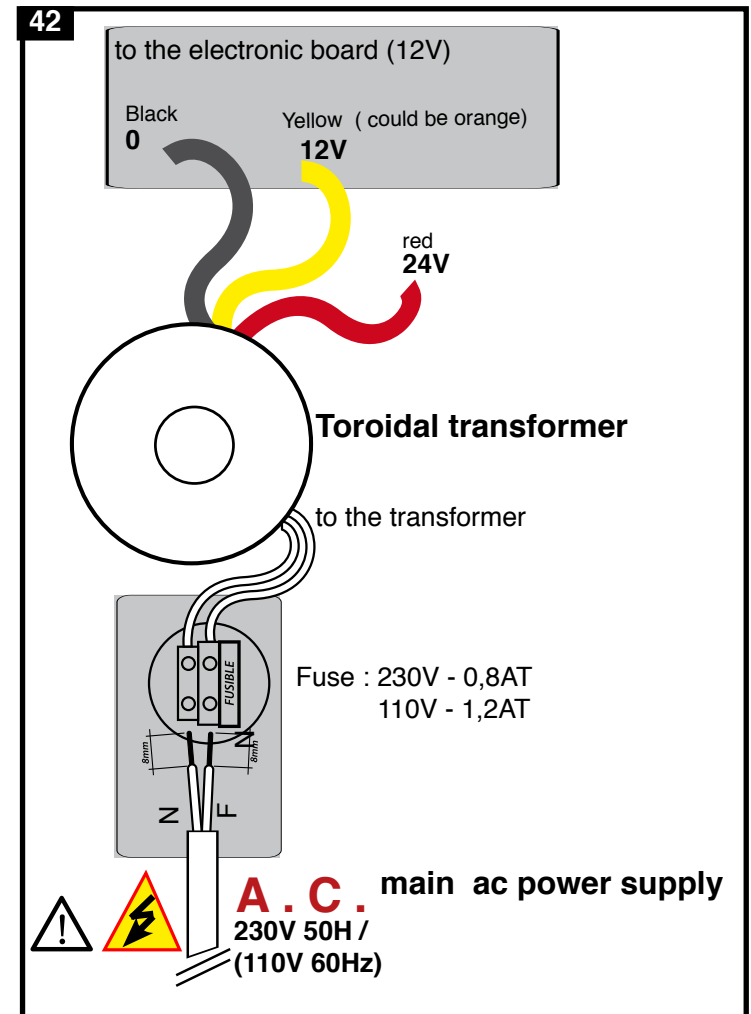



**VIDEO
MANUAL**



**product
page [www](#)**

- **CTH41**
Electronic board

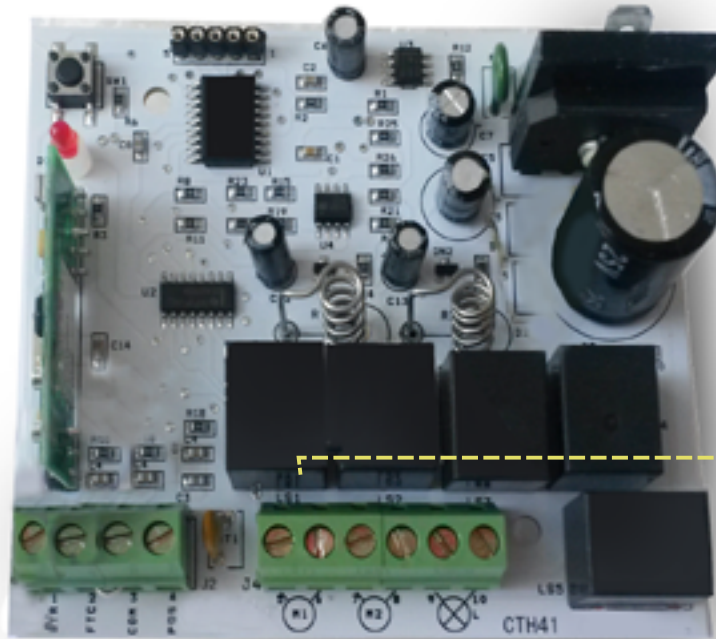

- **KONTROL 7851**
Complete control box with toroidal transformer and electronic board CTH41

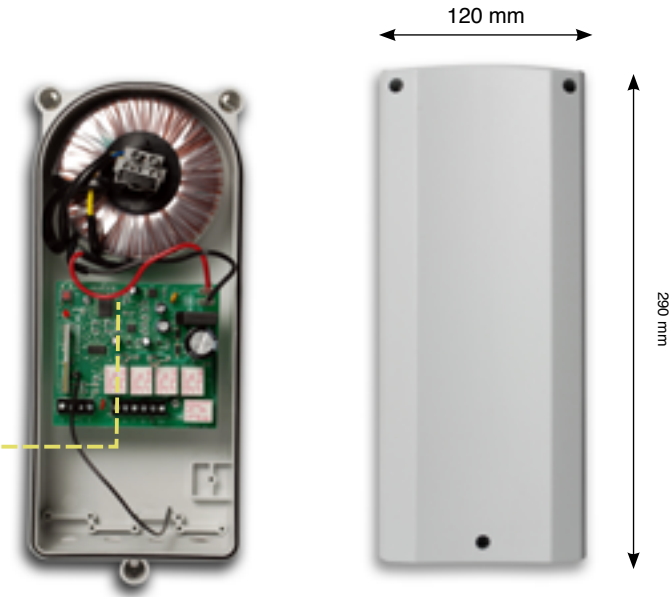

■ **Compatible accessories**

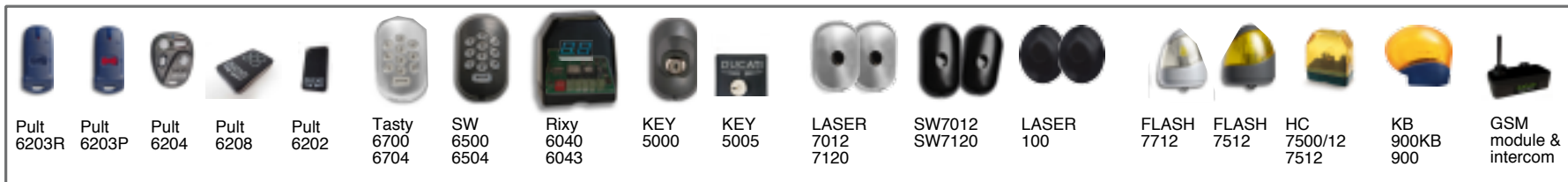

Toroidal transformer wiring to connectors (backside of CTH41) without polarity to be respected. yellow /orange cable = 12V black cable = 0

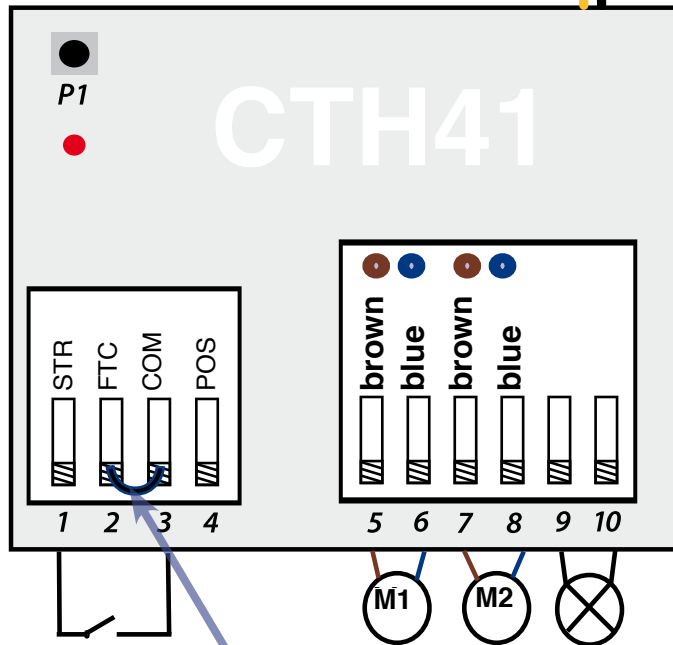
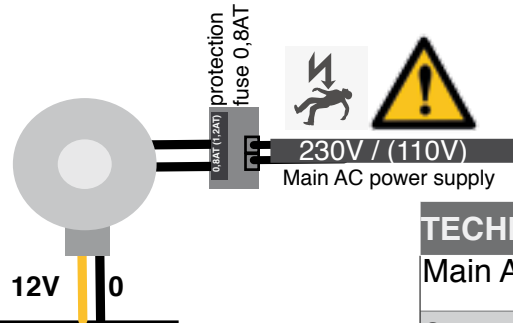

VIDEO -
MANUAL

WARNING:

the electronic board is made to stop the motors by amperometrical obstacle detection: it is required that the gate is featured with mechanical end limits fixed on the floor (where the motors do not include integrated end limits). Once the gate reaches the limit end, the ampere absorption increase will be detected by the electronic board that will stop the motors.

TECHNNICAL DATA	CTH41	CTH41 MONO
Main AC power supply	230V (110V version available) by included toroidal transformer	
System operating voltage	12V	
Compatible with swing gate	2 wings	1 wing
Transformer protection fuse	√ 0,8AT (1,2AT)	
Protection fuse	√ automatic	
Toroidal transformer	105W	
Outputs power connectors	12V	
Stand-by energy consumption	0,008A	
Radio receiver	1 channel to command the full opening cycle	
Remote control codes storage capacity	up to 10	
Radio transmission protocol	DUCATI rolling code 433MHz	
Remote controls automatic learning	√	
On board antenna cable	√	
Automatic closure working mode	√ with pause time 30 sec. (not adjustable)	
Step by step working mode	√ push to open-push to close	
Anti-crushing safety system in compliance to the EU Norms EN13241 / EN12453	√ amperometrical obstacle detection system	
Input connectors for infrared safety photocells	√ (NC contact) by closing will reverse if something interrupting safety infrared light (prevent contact)	
Input connectors for a full cycle opening wired command	√ (NO contact)	

CTH41-MONO is a specific version to be used use on single wing gate: only connect M1. Other connections remain the same. Warning: CTH41 with standard dual wing software cannot be used on single wing gate.

Photocells bridge

Warning: If you do not connect any photocell (infrared safety sensor) keep the contact closed with the supplied electric bridge placed on connectors 2 & 3 (NC= Normally closed contact).

If the contact gets open and no photocells are wired the gate opener will open but not close until the contact get closed again.

Warning

M1 = Motor installed on the wing that opens first

M2 = Motor installed on the wing that opens as second

NO contact to command full opening by a wired command (key-switch or intercom button)



Connections and adjustments:

WARNING ! all settings have to be made with gate in closed position

Attention! Visual warning of the state of the gate:

By closed gate the RED LED is OFF. By open gate the RED LED is on by step by step working mode, or blinks by automatic closure working mode.

CTH41 Wiring instructions

- 1 **(STR) START** NO (normally open) contact for full cycle command
- 2 **(FTC) NC** (normally closed) contact for infrared photocells contact FTC
- 3 **(COM)** ground / common (for START and/or Photocells)
also Photocells negative power output
- 4 **(POS)** + Photocells positive power output
- 5 M1 motor cable brown
- 6 M1 motor cable blue
- 7 M2 motor cable brown
- 8 M2 motor cable blue
- 9-10 blinking light 12V max 10W (no polarity to be respected)



Warning: If you do not connect any photocell (infrared safety sensor) keep the contact closed with the supplied electric bridge placed on connectors **2 & 3 (NC= Normally closed contact)**.

If the contact gets open and no photocells are wired the gate opener will open but not close until the contact gets closed again.



Warning

M1 = Motor installed on the wing that opens first

M2 = Motor installed on the wing that opens as second

The phase shift between the 2 wings is automatically set and can not be modified. M1 motor will open first and M2 will follow opening after about 3-4 seconds and vice versa in closing.

P1 Push button to store and delete remote controls

LED-light warnings:

red LED is on after pushing P1 button = remote control learning mode.

red LED is on by open gate = The gate is open in "step-by-step" working mode

red LED blinks by open gate = The gate is open in "automatic closure" working mode. the LED will blink until countdown (30 sec) ends and gate automatically close.

REMOTE CONTROLS (FOB)

Warning: control board model CTH41 can storage up to 10 ducati rolling coded remote controls buttons. In case you need to use more than 10 remote controls,

you can purchase an extra (optional) Ducati radio receiver (RIXY6040 or RIXY 6043).

A) How to memorize a remote control button in the control board memory

Warning: Gate must be closed and idle.

- 1) on the main electronic board press push button **P1**
 - the red LED will switch on (to confirm you entered the learning mode)
- 2) release **P1**
- 3) Press the remote control button you want to use to operate your gate. Hold the remote control button pressed for at least 3-4 seconds
 - once the main electronic board has stored the remote control the main control's board red LED will blink shortly to confirm remote control button has been memorized.
 - wait for the main board's red LED to switch off.
- 4) You can now use the stored remote control's button to command your gate manoeuvre. (Same remote control's button will operate both opening and closing of your gate). Repeat this operation for all desired remote controls.

B) How to delete all remote controls from the memory of your control board

In case where the electronic board's memory is full or if a remote control is lost, it is possible to erase the stored remotes controls from the memory of the electronic board (attention this process leads to a total loss of memory). Thereafter, the remote controls must be re-stored on the board.

Warning: Gate must be closed and idle.

- 1) on the main electronic board press push button **P1** and hold it pushed for about 30 seconds until the red LED blinks to confirm all memory has been deleted
- 2) release **P1**

Memorize again the remaining remotes you want to use by following instructions as in point A) here above. repeat the procedure for each remote control

Working mode:

2 working mode are available:

A) STEP BY STEP = you push to command the opening of the gate and you will need to push again to command the closure of the gate.

B) AUTOMATIC CLOSURE = you push to command the opening of the gate, the gate will remain open for a pause time of 30 seconds then will close automatically, no further command will be accepted while the gate is counting-down pause time.

The board is delivered in standard working mode "step by step" automatic closing: proceed as follows:

- 1- switch off main AC power supply
- 2- wait at least 5 seconds
- 3- press and keep pressed P1
- 4- keeping pressed P1, feeds the electronic board again

The red LED goes on. Operation performed.

The same procedure can be used to return to "step by step" mode.



VIDEO -
MANUAL



product
page [www](#)

- **C/M/BAT * (*optional)**
extra Battery Charger Management Module
(this is a mandatory additional optional to connect an emergency back-upbattery)

- **KONTROL 7855**
Complete control unit: large control box with inner battery* storage compartment, CTH42 board and toroidal

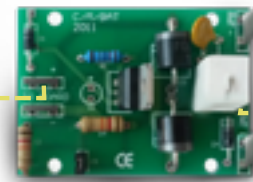
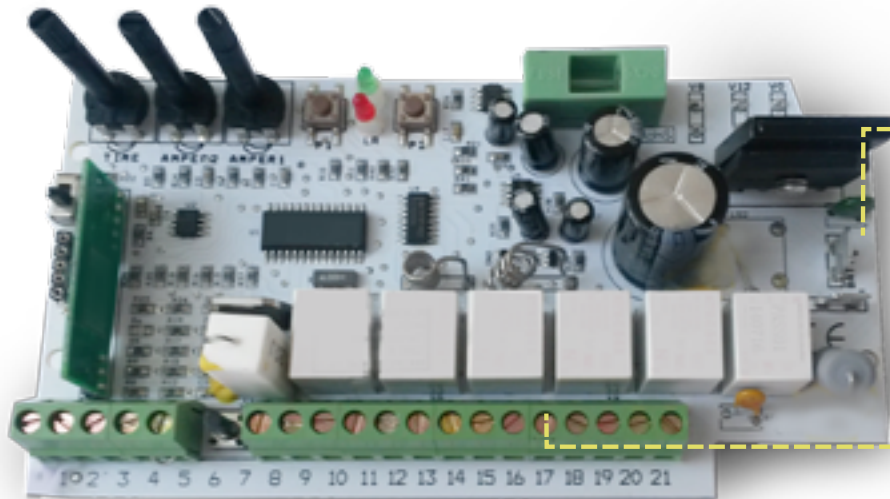

C/M/BAT

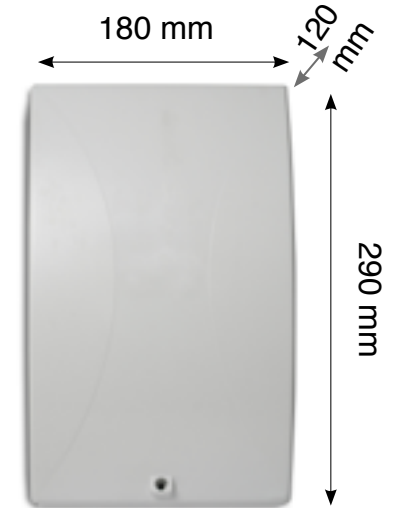
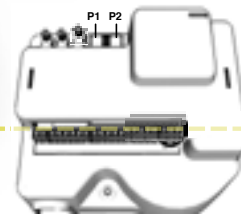

- **CTH42**
Electronic board

WARNING:

the electronic board is made to stop the motors by amperometrical obstacle detection: it is required that the gate is featured with mechanical end limits fixed on the floor (where the motors do not include integrated end limits).
Once the gate reaches the limit end, the ampere absorption increase will be detected by the electronic board that will stop the motors.

- Compatible accessories

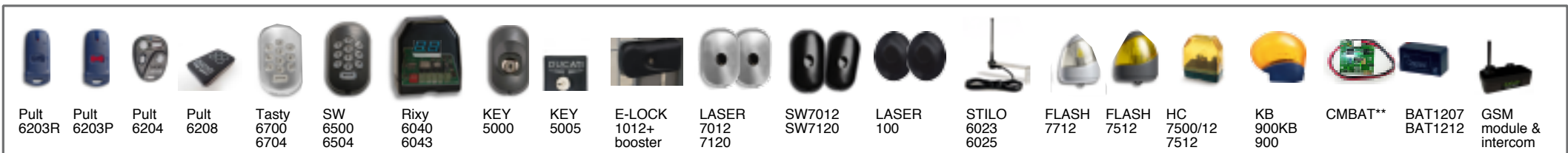

Technical data	CTH42
Main AC power supply	230V (110V version available on demand) by included toroidal transformer
System operating voltage	12V
Compatible with swing gate	√
Transformer protection fuse	√ 10AF
Protection fuse	0,8A T (1,2A T)
Toroidal transformer	105W
Outputs power connectors	12V
Stand-by energy consumption	0,012A
Radio receiver	2 channels: 1 for full opening, 1 for pedestrian opening (only 1 wing partial opening)
Remote control codes storage capacity	10
Radio transmission protocol	DUCATI rolling code 433MHz
Remote controls automatic learning	√
On board antenna cable	√
Connectors to wire an external aerial antenna	√
Automatic closure working mode	adjustable pause time up to 100 sec.
Step by step working mode	√ push to open-push to close
Anti-crushing safety system in compliance to the EU Norms EN13241 / EN12453	√ Amperometrical obstacle detection safety system
Asadjustable motor power	√ Turning the potentiometer clockwise will increase motor power and reduce obstacle detection sensibility
Output for courtesy light (timerized 60 seconds)	√ 12V max 10W
Output for Electric lock	√ 12V ac Warning: not comaptible if the electronic board is powered by back-up battery
Input connectors for safety infrared sensors	√ (NC) while gate is closing if the (NC) contact is opened (breaking the infrared beam) gate will reverse mouvement and re-open)
Input connectors for a full cycle opening wired command	√ (NO contact)
Input connectors for a fpedestrian cycle wired command	√ (NO contact)
output for blinking warning light	√ 12V max 10W (blinks slowly while opening, blinks quickly by closing)
compatible with back-up battery power supply	√ only buy adding the optional battery charger module (CMBAT)
LED indication of Power supply	√ Green LED on while the electronic board is powered
Gear anti-pressure system	√



VIDEO -MANUAL

turn fully anti-clockwise to set "step-by-step" working mode = push to open / push to close

Turn clockwise to increase motor power

turn clockwise to set automatic closure working mode and set pause time up to 100 sec.

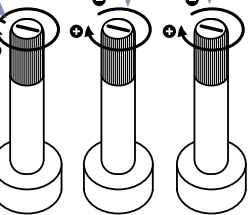

P1 memorize / delate remote controls for full opening
 green LED = Board powered
 red LED = by open gate steady on if step-by-step working mode is set; blinks if automatic closure is set

Toroidal transformer 105W 0-12V output wiring to connectors backside of CTH42 without polarity to be respected.

Protection Fuse 0,8 AT (-1,2AT)

Main AC power supply 230V(110V)

Photocells bridge

Warning: If you do not connect any photocell (infrared safety sensor) keep the contact closed with the supplied electric bridge placed on connectors 4 & 5 (NC= Normally closed contact). If the contact gets open and no photocells are wired the gate opener will open but not close.

Use on 1 wing gate

Use on 2 wings gate

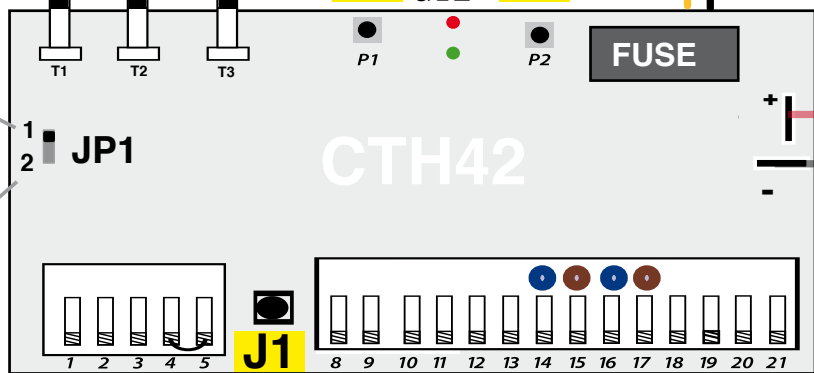

CMBAT is an required additional module to manage the back-up battery charge. **Warning: battery cannot be wired to CTH42 without CMBAT**

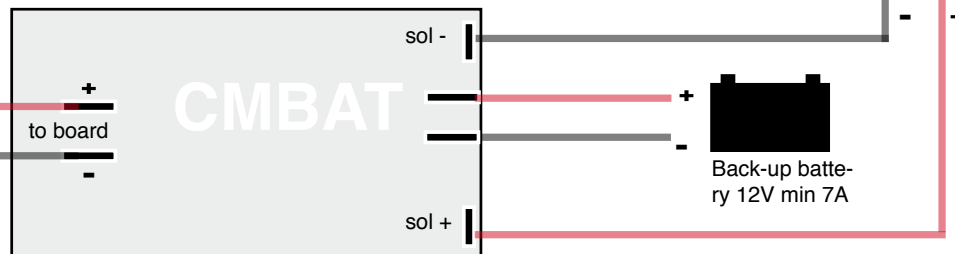

SOLAR PANEL 12V min. 10W

Back-up battery 12V min 7A

1=Antenna cable
2=ground

FTC (NC)

START NO contact to command full opening

memorize remote controls for pedestrian opening

START NO contact to command pedestrian opening

12V 10W max
+ -
12V 12V dc dc

12V ac Electric lock (not compatible if powered by back-up battery)

Warning
M1 = Motor installed on the wing that opens first
M2 = Motor installed on the wing that opens as second

A) How to wire a 12V max 10W timerized (60 sec.) courtesy light

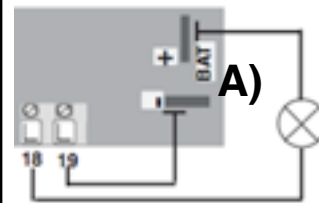

B) How to wire a 230V / 110V timerized (60 sec.) courtesy light
Warning: only by of an additional power relay (not supplied)

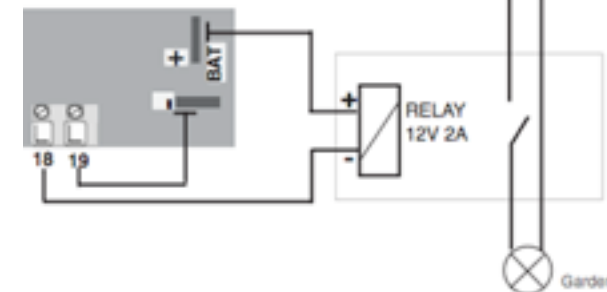



WARNING !
all settings have to be made with gate in closed position

Attention! Visual warning of the state of the gate:
By closed gate the RED LED is OFF. By open gate the RED LED is on by step by step working mode, or blinks by automatic closure working mode.

ADVISE: the CTH42 could switch to emergency status in case several emergency events happens. In this event you might reset the board by following this procedure: close the contact make a temporary electric bridge between connectors 8-9 for 2 seconds (RESET maneuver).

CTH42 wiring instructions

- 1 Antenna cable
 - 2 Antenna ground
 - 3/5 **START** NO (normally open) contact for full opening cycle
 - 4 **FTC** safety infrared photocells NC (normally closed) contact
 - 5 Common/ ground (for both Start and Photocells)
 - 8/9 **START** NO (normally open) contact for pedestrian opening cycle
 - 10 + 12V dc positive power output for photocells
 - 11 - 12V dc negative power output for photocells
 - 12/13 Blinking light 12V 10W max.
 - 14 M2 motor (actuator) blue cable
 - 15 M2 motor (actuator) brown cable
 - 16 M1 motor (actuator) blue cable
 - 17 M1 motor (actuator) brown cable
 - 18/19 output for garden/courtesy light (contact NO/NC max 0,5A) use a relay if ac
 - 20/21 12V ac electrolock output (not to be used if powered by battery) protection fuse 10AF
- Connectors (BAT+/-) to battery charger module **CMBAT**



Warning: do not connect a back-up battery directly to the CTH42 electronic board. Always to be connected by means of extra module CMBAT to be purchased separately

Transformer input: connect 0= black cable + 12V yellow-orange cable to the CTH42 backside connectors. No polarity to be respected.



Photocells bridge Warning: If you do not connect any photocell (infrared safety sensor) keep the contact closed with the supplied electric bridge placed on connectors **4 & 5 (NC= Normally closed contact)** If the contact gets open and no photocells are wired the gate opener If the contact gets open and no photocells are wired the gate opener will open but not close.

M1 = Motor installed on the wing that opens first
M2 = Motor installed on the wing that opens as second
The phase shift in between gate wings is automatically set.
M2 follows M1 in opening after about 3 sec. and vice versa during closing.

JP1 SWITCH

JP1 switched on position 1= 1 wing gate use / JP1 switched on position 2= 2 wing gate use
USE ON SINGLE WING GATE: wire the actuator as M1 and place the switch jumper **JP1** on position 1 (= 1 wing gate use)

USE ON GATE OPENING TOWARDS OUTSIDE (push-to-open)

You must reverse motor cable polarity (reverse blue-brown cable for M1 and same for M2)

VIDEO -MANUAL



Push buttons & Potentiometers

P1 = **FULL CYCLE** push button to store or cancel the radio transmitters (FOB) codes on the electronic board. This button is used to memorize a remote control button used to command full opening cycles.

J1 = **PEDESTRIAN ACCESS** push button to store the radio transmitters (FOB) codes on the electronic board. This button is used to memorize a remote control button used to command pedestrian opening cycles nly M1 actuator's gate wing will partially open to limit the access to pedestrians only.

P2 = **deactivate/activate the Gear anti-pressure system.** This function is automatically set in the board and which removes pressure from the gears to preserve the life of the system
To delate this feature: press P1 for 1 second. the red LED lights. Press P2 for a second. function deactivated. To restore the function, repeat the procedure.

Trimmer 1 (TIME) = potentiometer to set the “step by step” mode of use or automatic closure
Trimmer 2 (POWER M1) = actuator M1 power /obstacle detection sensitivity adjustment
Trimmer 3 (POWER M2) = actuator M2 power /obstacle detection sensitivity adjustment

LED-light warnings:

green LED on= the electronic board is powered.
red LED is on after pushing P1 button = remote control learning mode.
red LED is on by open gate = The gate is open in “step-by-step” working mode
red LED blinks by open gate = The gate is open in “automatic closure” working mode. the LED will blink until countdown ends and gate automatically close.

WIRED COMMANDS:

START: by wiring a clean monostable NO switch you can command the full opening cycle by a wired command (key switch/ intercom button , or any additional additional button) both wings will open and both wings will close.
START PEDESTRIAN: same as above but to command the pedestrian opening cycle (only M1 actuator's gate wing will partially open to limit the access to pedestrians only.



WORKING MODE

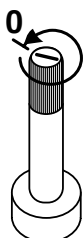

Time

“**STEP-BY-STEP**” working mode = with this setting a command will open the gate and a second command will command the closing of the gate. The gate will open and stop by reaching the mechanical end stop. During opening it is not possible to stop or reverse the gate. No commands are accepted until the gate is stationary open. The gate remains open until a new command will produce the closing of the gate. The command can be given by remote control or wired command (key-switch, or any other N.O. contact bistable switch)

To set this working mode turn potentiometer “**TIME**” fully anti-clockwise (position = 0)

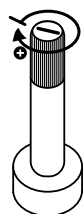

Time

“**AUTOMATI CLOSURE**” working mode = With this setting a command will open the gate. The gate will open and stop by reaching the mechanical end stop. The gate remains open in the pause (pause time can be set up to max.100 seconds) after the pause time has expired the gate will automatically close. During opening and during pause time it is not possible to stop or reverse the gate. No commands are accepted during pause time.

To set this working mode turn potentiometer “**TIME**” clockwise, the more you turn in clockwise sense, the more you increase the pause time before gate will automatically close. max. pause time is 100 seconds.

MOTOR POWER ADJUSTMENT

By increasing motor power you reduce the obstacle detection sensitivity:

Motor M1: turn potentiometer “**POWER M1**” clockwise to increase the power

Motor M2: turn potentiometer “**POWER M2**” clockwise to increase the power

TIME SHIFT (delay time in opening and closing between the 2 wings)

The delay time between wing 1 (M1) and wing 2 (M2) is automatic.

At the opening M1 starts to open first, and M2 follows M1 after about 3 sec.

Vice versa when closing. In case M2 is installed on a wing opening with a greater opening angle than M1’s gate wing, it may be needed to increase the standard time shift between the wings. Time shift adjustment is available upon request, but as it requires a software adjustment it can be overtaken only by the manufacturer. Contact the manufacturer for more informations.

„RAM-SHOT“ or ANTI-PRESSION FUNCTION

This automatic function performs an almost unnoticeable reversing when the gate detects the mechanical end limit, to reduce the pressure on the gear wheel when the gate is in stop position, and guarantee long life term of all mechanical parts of the actuator. The board is standard programmed with this function activated. Even if it’s recommended to keep this function, it possible to deactivate it.

To deactivate the “Ram-shot” function, proceed as follows:
Press P1 for 1 second, the red LED lights up. Press P2 for one second. The function is deactivated. To restore the function, repeat the process.

REMOTE CONTROLS (FOB)

Warning: control board model CTH42 can storage up to 10 ducati rolling coded remote controls buttons. In case you need to use more than 10 remote controls, you can purchase an extra (optional) Ducati radio receiver (RIXY6040 or RIXY 6043). Warning: only original ducati rolling coded remote controls are compatible.

A-1) How to memorize a remote control button in the control board memory to command a FULL OPENING CYCLE (on 2 wings gate both wings will open and both wings will close/ on 1 wing gate the gate will fully open)

Warning: Gate must be closed and idle (check the RED LED is switched off).

- 1) on the main electronic board press push button **P1**
 - the red LED will switch on (to confirm you entered the learning mode)
- 2) release **P1**
- 3) Press the remote control button you want to use to operate your gate. Hold the remote control button pressed for at least 3-4 seconds
 - once the main electronic board has stored the remote control the main control’s board red LED will blink shortly to confirm remote control button has been memorized. Wait for the main board’s red LED to switch off.
- 4) You can now use the stored remote control’s button to command your gate manoeuver. (Same remote control’s button will operate both opening and closing of your gate). Repeat this operation for all desired remote controls.

A-2) How to memorize a remote control button in the control board memory to command a PEDESTRIAN OPENING CYCLE (on 2 wings gate only 1 wing will open partially and both wings will close/ on 1 wing gate the gate will fully open)
Repeat same procedure as above A-1) but use push button J1 instead of P1.

B) How to erase all remote controls from the memory of your control board

If the electronic board’s memory is full or if a remote control is lost, it is possible to erase the stored remotes controls from the memory of the electronic board (attention this process leads to a total loss of memory).

Thereafter, the remote controls must be re-stored on the board.

Warning: Gate must be closed and idle.

- 1) on the main electronic board press push button **P1** and hold it pushed for about 30 seconds until the red LED blinks to confirm all memory has been delated
 - 2) release **P1**
- Memorize again the remaining remotes you want to use by following instructions as in point A) here above. Repeat the procedure for each remote control



VIDEO -MANUAL



product page [www](http://www.ducatihomeautomation.com)



**GO GREEN!
ENERGY SAVING
DEVICE**

only **0,007A** stand-by power consumption

■ **CTH44**
Electronic board

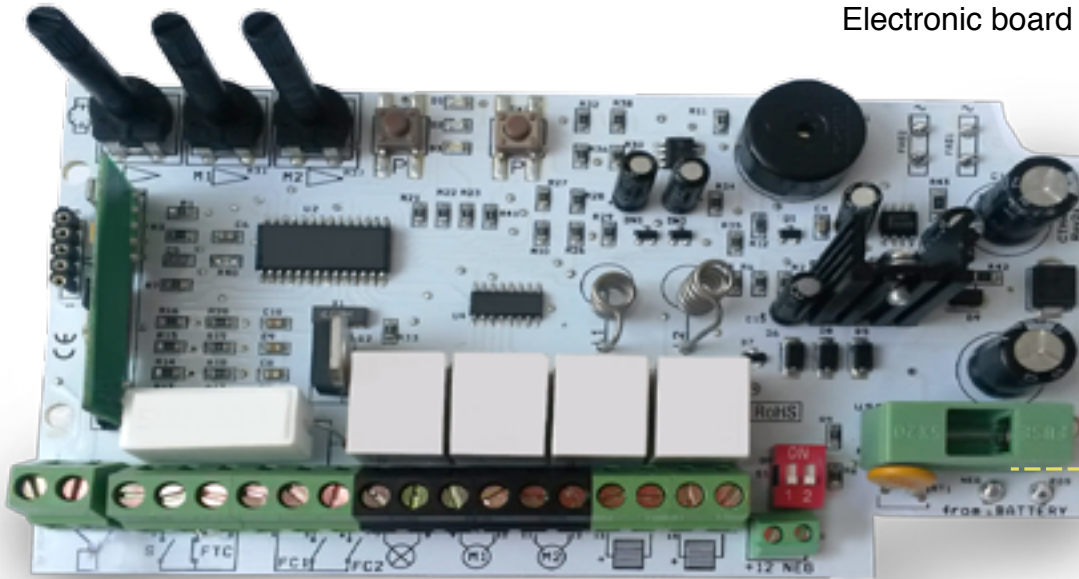

■ **KONTROL 7857**

Complete control unit: large control box with inner battery* storage compartment, CTH44 board and toroidal transformer

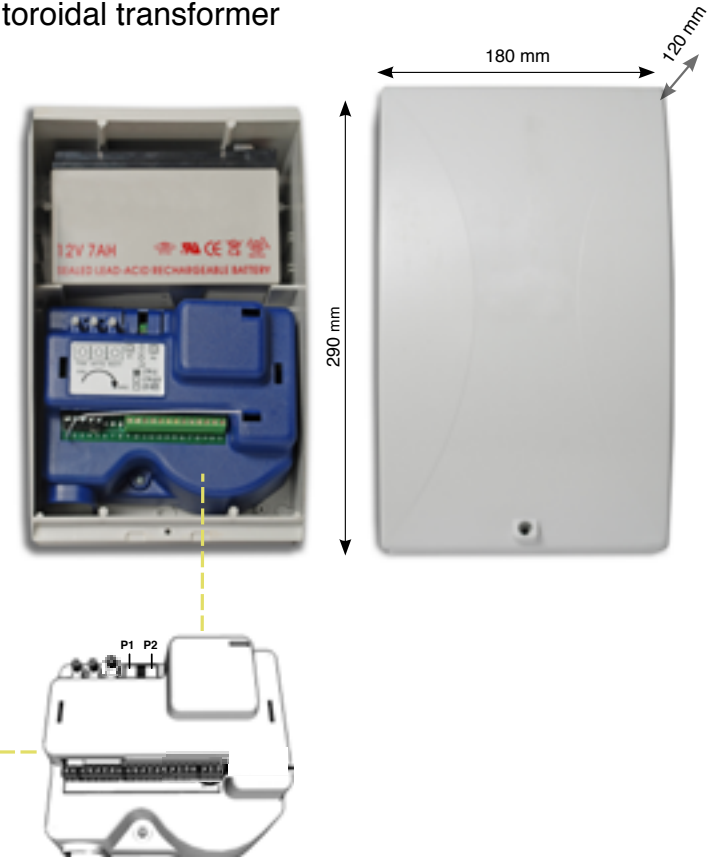

■ **Compatible accessories**

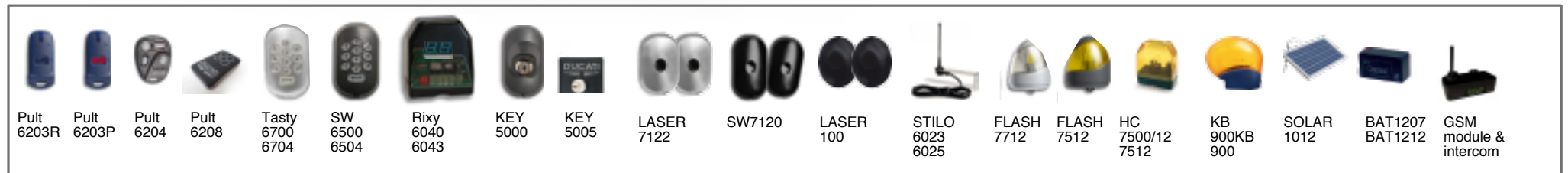



VIDEO -MANUAL

turn fully anti-clockwise to set "step-by-step" working mode = push to open / push to close

Turn clockwise to increase motor power

turn clockwise to set automatic closure working mode and set pause time up to 100 sec.

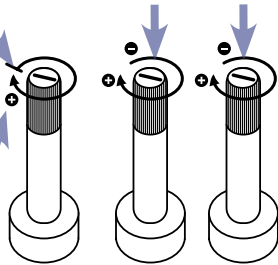

Time Power M1 Power M2

memorize / delate remote controls for full opening

P1

push to check the battery charge status (green= ok / yellow= need to recharge / red= out of power)

P2

Toroidal transformer 105W -0-12V output wiring to connectors backside of CTH44 without polarity to be respected.

Protection Fuse 0,8 AT (1,2AT)



Main AC power supply by 230V(110V)

CTH44 can be powered also by AC main power supply, but requires always a back-up battery to be kept connected. AC will recharge the battery and keep it charged.

12V = (yellow/orange) 0 = (black)

Photocells bridge

Warning: If you do not connect any photocell (infrared safety sensor) keep the contact closed with the supplied electric bridge placed on connectors 2 & 3 (NC= Normally closed contact).

If the contact gets open and no photocells are wired the gate opener will open but not close.

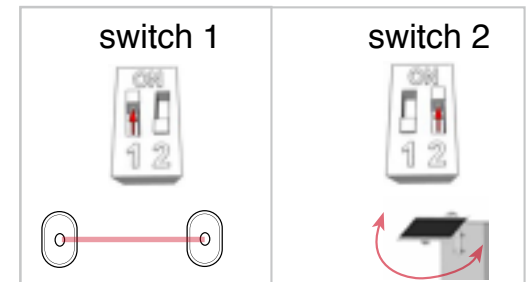
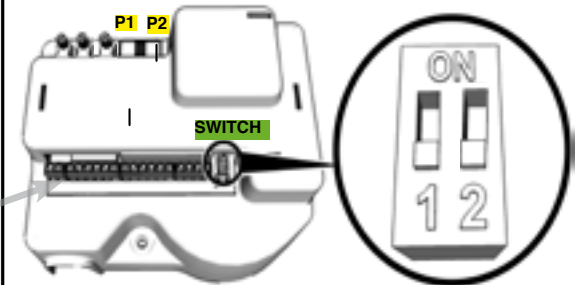
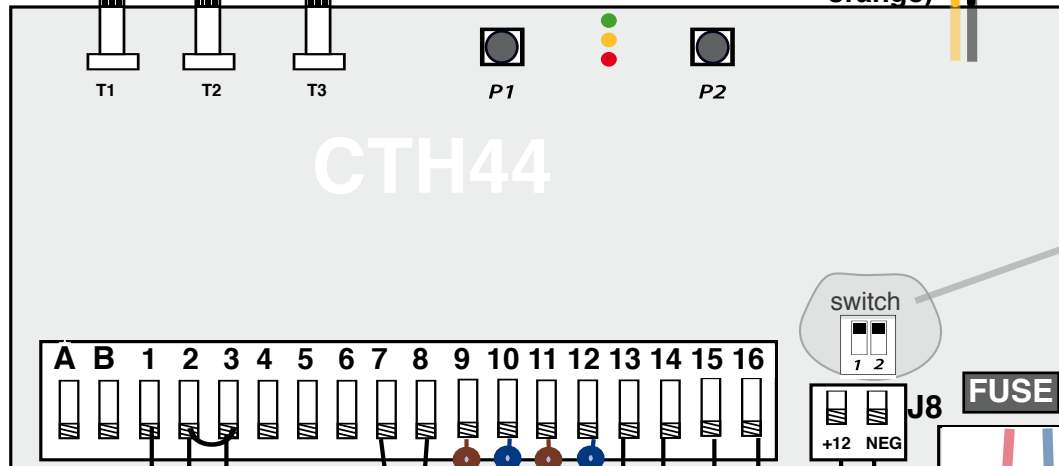

switch 1 in ON position only while you need the photocell correct alignment warning signal. After finishing reposition the switch downwards.

switch 2 in ON position only while adjusting the solar panel position. After finishing reposition the switch downwards.

12V battery min. 7A

Warning: respect cable polarity to avoid damages on the CTH44 board when wiring the battery. Blue cable = - negative / red cable= + positive

Warning

M1 = Motor installed on the wing that opens first

M2 = Motor installed on the wing that opens as second

WARNING :

If you want to add infrared safety sensor to a solar powered gate opener it is recommended to use reduced consumption photocells only (optionals). suggested models are DUCATI's SW7120 /LASER 7120 oder LASER 100 or LASER 200

⚠ WARNING ! All settings have to be made with gate in closed position

⚠ WARNING ! Before use, make sure the battery must be charged.

HOW TO CHARGE THE BATTERY:

A) Use a 12V battery charger with charge control* not supplied (you can purchase optional battery charger MPBAT).

B) Charge the battery directly by the CTH44 by 23V main AC power supply (through the supplied toroidal transformer) To do this: wire the 12V battery to the CTH44 by respecting polarity: red cable = + positive; blue cable = - negative
Connect a min.0.75 mm² cable with plug to the connectors placed before the transformer. Connect a cable with an electrical plug to the electrical terminals downstream of the transformer. Remove the protection cover of the control unit to identify the AC power connection terminals fixed on the bottom of the control unit (see page 34). Connect to an electrical outlet. Charge for about 16 h. As the battery is charged disconnect AC power supply.

⚠ Warning: after having connected a fully charged battery it is mandatory to make the board check the battery charge status by pushing **P2**.

Push P2 button to check the battery charge status. Make sure the green LED switches on to confirm the fully charged state of the battery. Refraining from this check may result in the non-functioning of the board which remains in a low charge battery alarm status.

CTH44 Wiring instructions

A Antenne cable

B Antenne ground

1/3 START NO (normally open) contact for full opening cycle

2 FTC safety infrared photocells NC (normally closed) contact

3 Common/ ground (for both Start and Photocells)

7/8 Blinking light 12V 10W max.

9 M1 motor (actuator) brown cable

10 M1 motor (actuator) blue cable

11 M2 motor (actuator) brown cable

12 M2 motor (actuator) blue cable

13 + 12V dc positive power input from solar panel

14 - 12V dc negative power input from solar panel

15 + 12V dc positive power input from 2° solar panel (optional not mandatory)

16 - 12V dc negative power input from 2° solar panel (optional not mandatory)

J8: + **12** dc positive power output for photocells/ services

NEG - 12V dc negative power output for photocells/v

Protection fuse 10AF

BLUE-RED cables to be connected to the battery poles. Warning: respect polarity!

BLUE= negative - / RED = positive+



Warning:

M1 = Motor installed on the wing that opens first

M2 = Motor installed on the wing that opens as second



Use on single wing gate: wire the motor as M1



Warning: use on gates opening towards outside (push-to-open)

You must reverse motor cable polarity (reverse blue-brown cable for M1 and same for M2)



VIDEO -MANUAL

PHOTOCELLS - FTC Contact how it works:

photocells are optional safety devices that are active only in the closing cycle of the gate. Interrupting the infrared beam during the closing maneuver will result in reverse and immediate reopening of the gate. **Warning:** If you do not connect any photocell (infrared safety sensor) keep the **FTC** photocell infrared contact closed by the supplied electric bridge placed on connectors **2 & 3 (NC= Normally closed contact)**.
If the contact gets open and no photocells are wired the gate opener will open but not close.

CTH 42 Push buttons and functions

P1 FULL CYCLE REMOTE CONTROL LEARNING push button to store or cancel

the radio transmitters (FOB) codes on the electronic board. This button is used to memorize a remote control button used to command full opening cycles.

P2 BATTERY CHECK by pushing P2 you check the battery charge status.

Green LED on = Battery OK, Yellow LED on = need to recharge,

Red LED on= EMERGENCY STATE the board will not work correctly

Trimmer 1 (TIME) = potentiometer to set the “step by step” or automatic closure

Trimmer 2 (POWER M1) = actuator M1 power /obstacle detection sensitivity adjustment

Trimmer 3 (POWER M2) = actuator M2 power /obstacle detection sensitivity adjustment

LED-light warnings:

green LED on after pushing P2 = battery is fully charged

yellow LED on after pushing P2 = battery needs to be recharged

red LED on after pushing P2 = emergency state. battery out of power

red LED on after pushing P1 = entered in remote control learning mode

WIRED COMMANDS:

START: by wiring a bistable NO switch you can command the full opening cycle by a wired command (key switch/ intercom button, or any additional additional button) both wings will open and both wings will close.



WORKING MODE

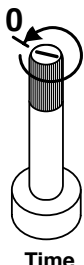

Time

“STEP-BY-STEP” working mode = with this setting a command will open the gate and a second command will command the closing of the gate. The gate will open and stop by reaching the mechanical end stop. During opening it is not possible to stop or reverse the gate. No commands are accepted until the gate is stationary open. The gate remains open until a new command will produce the closing of the gate. The command can be given by remote control or wired command (key-switch, or any other N.O. contact bistable switch)

To set this working mode turn potentiometer “TIME” fully anti-clockwise (position = 0)

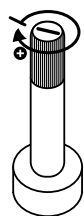

Time

“AUTOMATI CLOSURE” working mode = With this setting a command will open the gate. The gate will open and stop by reaching the mechanical end stop. The gate remains open in the pause (pause time can be set up to max.100 seconds) after the pause time has expired the gate will automatically close. During opening and during pause time it is not possible to stop or reverse the gate. No commands are accepted during pause time.

To set this working mode turn potentiometer “TIME” clockwise, the more you turn in clockwise sense, the more you increase the pause time before gate will automatically close. max. pause time is 100 seconds.

MOTOR POWER ADJUSTMENT

By increasing motor power you reduce the obstacle detection sensitivity:

Motor M1: turn potentiometer **“POWER M1”** clockwise to increase the power

Motor M2: turn potentiometer **“POWER M2”** clockwise to increase the power

TIME SHIFT

(delay time in opening and closing between the 2 wings)

The delay time between wing 1 (M1) and wing 2 (M2) is automatic.

At the opening M1 starts to open first, and M2 follows M1 after about 3 sec.

Vice versa when closing.

In case M2 is installed on a wing opening with a greater opening angle than M1's gate wing, it may be needed to increase the standard time shift between the wings. Time shift adjustment is available upon request, but as it requires a software adjustment it can be overtaken only by the manufacturer. Contact the manufacturer for more informations.

REMOTE CONTROLS (FOB)

Warning: control board model CTH44 can storage up to 10 ducati rolling coded remote controls buttons. In case you need to use more than 10 remote controls, you can purchase an extra (optional) Ducati radio receiver (RIXY6040 or RIXY 6043). Warning: only original ducati rolling coded remote controls are compatible.

A-1) How to memorize a remote control button in the control board memory to command a FULL OPENING CYCLE (on 2 wings gate both wings will open and both wings will close/ on 1 wing gate the gate will fully open)



Warning: Gate must be closed and idle (check the RED LED is switched off).

- 1) on the main electronic board press push button **P1**
 - the red LED will switch on (to confirm you entered the learning mode)
- 2) release **P1**
- 3) Press the remote control button you want to use to operate your gate. Hold the remote control button pressed for at least 3-4 seconds
 - once the main electronic board has stored the remote control the main control's board red LED will blink shortly to confirm remote control button has been stored. Wait for the main board's red LED to switch off.
- 4) You can now use the stored remote control's button to command your gate maneuver. (Same remote control's button will operate both opening and closing of your gate). Repeat this operation for all desired remote controls.

A-2) How to memorize a remote control button in the control board memory to command a PEDESTRIAN OPENING CYCLE

- 1) Press **P1**, and Keeping **P1** pressed, press also **P2**,
 - the red LED will switch on (to confirm you entered the learning mode)
- 2) release both **P1** and **P2**.
- 3) Press the remote control button you want to use to operate your gate for pedestrian opening and hold it pressed few seconds.
- 4) On the board the red LED blinks to confirm it has been stored.

B) How to erase all remote controls from the memory of your control board

If the electronic board's memory is full or if a remote control is lost, it is possible to erase the stored remotes controls from the memory of the electronic board (attention this process leads to a total loss of memory).

Thereafter, the remote controls must be re-stored on the board.

Warning: Gate must be closed and idle.

- 1) on the main electronic board press push button **P1** and hold it pushed for about 30 seconds until the red LED blinks to confirm all memory has been delated
- 2) release **P1**

Memorize again the remaining remotes you want to use by following instructions as in point A) here above. Repeat the procedure for each remote control

HOW TO CHECK THE BATTERY CHARGE STATE

When the battery is discharged, the system goes into a SAFETY PROTECTION SAFETY MODE and will not work until the battery is fully charged and the control gives a positive result. It is necessary to repeat the check every time after the battery has been charged, so that the board registers the new data and reset all functionality

- 1) Disconnect the solar panel cables
- 2) Push P2 button to check the battery charge status. You will have a visual and acoustic response:

Red LED lights on with beep = battery discharged: the voltage is lower than 11.2V

Yellow LED lights on = battery partially discharged: the voltage is between 12.2 -12.9V

Green LED lights on = battery fully charged: the voltage is greater than 12.9V.

Once done, re-connect the solar panel.

WARNING:

In case the battery, despite being correctly recharged, is never sufficiently charged, it may be exhausted. in this case replace it with a new battery

DEEP SWITCH



SWITCH 1 = ON position: activates the acoustic-visual help for the correct infrared sensor alignment

green LED + quick acoustic buzzer = the photocells are aligned correctly.

red LED / intermittent acoustic buzzer= the photocells are misaligned

When finished, turn the switch to the lower position!



SWITCH 2 = ON position: activates the acoustic-visual help for the correct solar panel alignment

green LED + = SOLAR panel aligned correctly.

yellow or red LED / intermittent acoustic buzzer= SOLAR panel is misaligned

When finished, turn the switch to the lower position!



Caution: For this procedure, the battery must be disconnected and the test carried out only with the connected solar module.

After completion, reconnect the battery.

Power supply by battery and solar panel

Use a fully charged 12V min.7A battery

Use the 2 wires welded to the backside of the control board CTH44 to connect the battery to the board.



Warning: make sure to respect the correct polarity:

Blue (or black) cable to the negative pole of the battery;

Red cable to the positive pole of the battery .



Connect a solar panel 12V min.10W to the board CTH44 by means of bipolar (outdoor use min. 0,5mmq cable) with the utmost attention to the polarity of the terminals:

connector n° 13 + solar panel positive

connector n° 14 - solar panel negative

The solar module should be directed towards the south (see also notes installation and positioning) and in a well-lit place. Avoid shadow zones, which reduce the load capacity considerably.

It is recommended to install the solar panel not over 10 meters from the electronic board to prevent unnecessary electrical losses.

The following table shows an estimated calculation of the autonomy in non-ideal weather conditions (winter cloudy weather) by use of a 10W solar panel and 7A battery.

The autonomy increases in case of use of to larger capacity battery (ex. 12V 12A) and larger solar module (ex. 12V 20W). Instead of using a larger solar module, on CTH44 it is possible to add a second solar panel to increase the charge capacity.

connector n° 15 + 2° solar panel positive

connector n° 16 - 2° solar panel negative

WARNING: by increasing the watt of the solar module, the battery capacity must also be increased.

For example: if using 20W 12V solar panel requires a 12V min 12V battery.

NOTE: you can also wire main ac power supply through a switch. The AC power supply can be switched on to recharge the battery in case of needs, DO not power the board by both solar panel and AC power supply at same time.

TABLE-	GATE	Stand-by consumption (A)	daily consumption	Consumption for a complete cycle (open+ close), (A)	Suumption of total n° of daily cycles (open+close)	total daily consumption (A)	average charge of a 10W 12V solar panel (A /hour) in non ideal weather	hypotesis of lixght exposure (hours/per day)	Total recharge capacity (A)	balance between consumption and recharge
CTH44	1 wing	0,007	0,16	0,012	60	0,88	0,3*	5	1,5	+ 0,62
	2 wings			0,024	50	1,36				+ 0,14



product
page [www](#)



only **0,007A** stand-by
power consumption

GO GREEN!
**ENERGY SAVING
DEVICE**

■ **CTH48**

12V Electronic control board for 12V motors

■ **CTH48 /24V**

Electronic control board for 24V motor

■ **KONTROL9048** Complete control unit:
large control box with inner battery* storage
compartment, CTH48 board and toroidal
transformer

■ **KONTROL 9048/24V**

Complete control unit: large control box with
inner battery* storage compartment, CTH48
/24V board and toroidal transformer

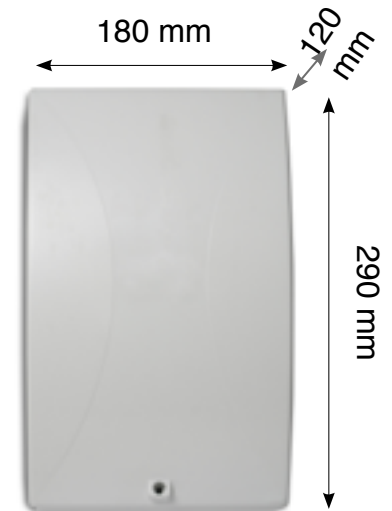
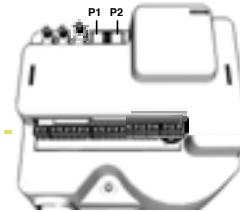

■ **Compatible accessories**

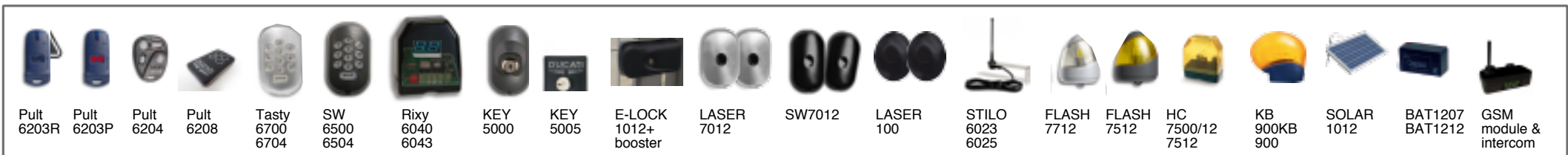

Technical data	CTH48	CTH48/24V
Main AC power supply	3 power supply options: a) by 230V (110V version available on demand) by included toroidal transformer b) by ac power supply + back-up battery;c) by back-up battery 12V min 7A+ solar panel 12V min 10W	3 power supply options: a) by 230V (110V version available on demand) by included toroidal transformer; b) by ac power supply + back-up battery; c) by back-up battery 2 x 12V min 7A in series connected + solar panel 24V min 20W
System operating voltage	12V	24V
Compatible with 1 or 2 wings swing gate		√
Transformer protection fuse	√ 10AF	
Protection fuse	0,8A T (1,2A T)	
Toroidal transformer		105W
Outputs power connectors	12V	24V
Stand-by energy consumption	0,007A	0,007A
Radio receiver	2 channels: 1 for full opening, 1 for pedestrian opening (only 1 wing partial opening)	2 channels: 1 for full opening, 1 for pedestrian opening (only 1 wing partial opening)
Remote control codes storage capacity	20	20
Radio transmission protocol	DUCATI rolling code 433MHz	DUCATI rolling code 433MHz
Remote controls automatic learning		√
On board antenna cable		√
Connectors to wire an aexternal aerial antenna		√
Automatic closure working mode		adjustable pause time up to 100 sec.
Step by step working mode		√ push to open-push to close
Anti-crushing safety system in compliance to the EU Norms EN13241 / EN12453		√ Amperometrical obstacle detection safety system
Asdjustable motor power	√ Turning the potentiometer clockwise will increase motor power and reduce obstacle detection sensibility	
Output for courtesy light (timerized 60 seconds)	√ 12V max 10W	√ 24V max 10W
Output for Electric lock	√ 12V/24V dc output Warning: requires a dc electric lock or a ac electric lock+ booster module to convert ac into dc current	
Input connectors for safety infrared sensors	√ (NC) while gate is closing if the (NC) contact is opened (breaking the infrared beam) gate will reverse mouvement and re-open)	
Input connectors for a full cycle opening wired command	√ (NO contact)	
Input connectors for a pedestrian cycle wired command	√ (NO contact)	
output for blinking warning light	√ 12V max 10W (blinks slowly while opening, blinks quickly by closing)	
Gear anti-pressure system	√	
Imput for emergency stop button switch	√ NC contact	
Output for remote gate status warning light	√ by gate closed light off, by opening gate light blinks slowly, by open gate light is steady on, by closing gate light blinks quickly	
2 speeds with SOFT STOP	√ during fast speed reverse in case of obstacle detection, by slow speed stops by reaching the end limits or an obstacle	

Start with the potentiometers positioned as follows:

- potentiometer **TIME**: turned counterclockwise
- potentiometer **SENS**: turned clockwise
- potentiometer **SLOW**: turned counterclockwise

TIME

fully turned counterclockwise
= step-by-step working mode

turned clockwise= automatic closure working mode with pause time up to 100sec.

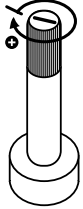

SENS

turned clockwise
= maximum motors power (reduced sensitivity in obstacle detection)

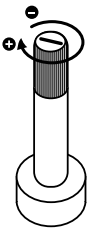

SLOW

Adjust the starting moment of the second phase (=soft stop/deceleration. Warning: during the first phase in case of touching an obstacle the gate will reverse direction, while in the second phase by detecting an obstacle the gate will stop. Turn counterclockwise to anticipate the second phase

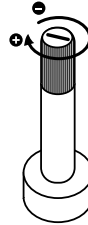

CAUTION

SLOW: never turn completely clockwise

WARNING ! On CTH48, the movement of the gate takes place in two phases: in the first phase at normal speed, in case of an impact on an obstacle, the direction of travel is inverted. In the second phase (Blue LED lights) at slow speed, in case of an impact on an obstacle, the movement is stopped. This happens even if the softstop is deactivated

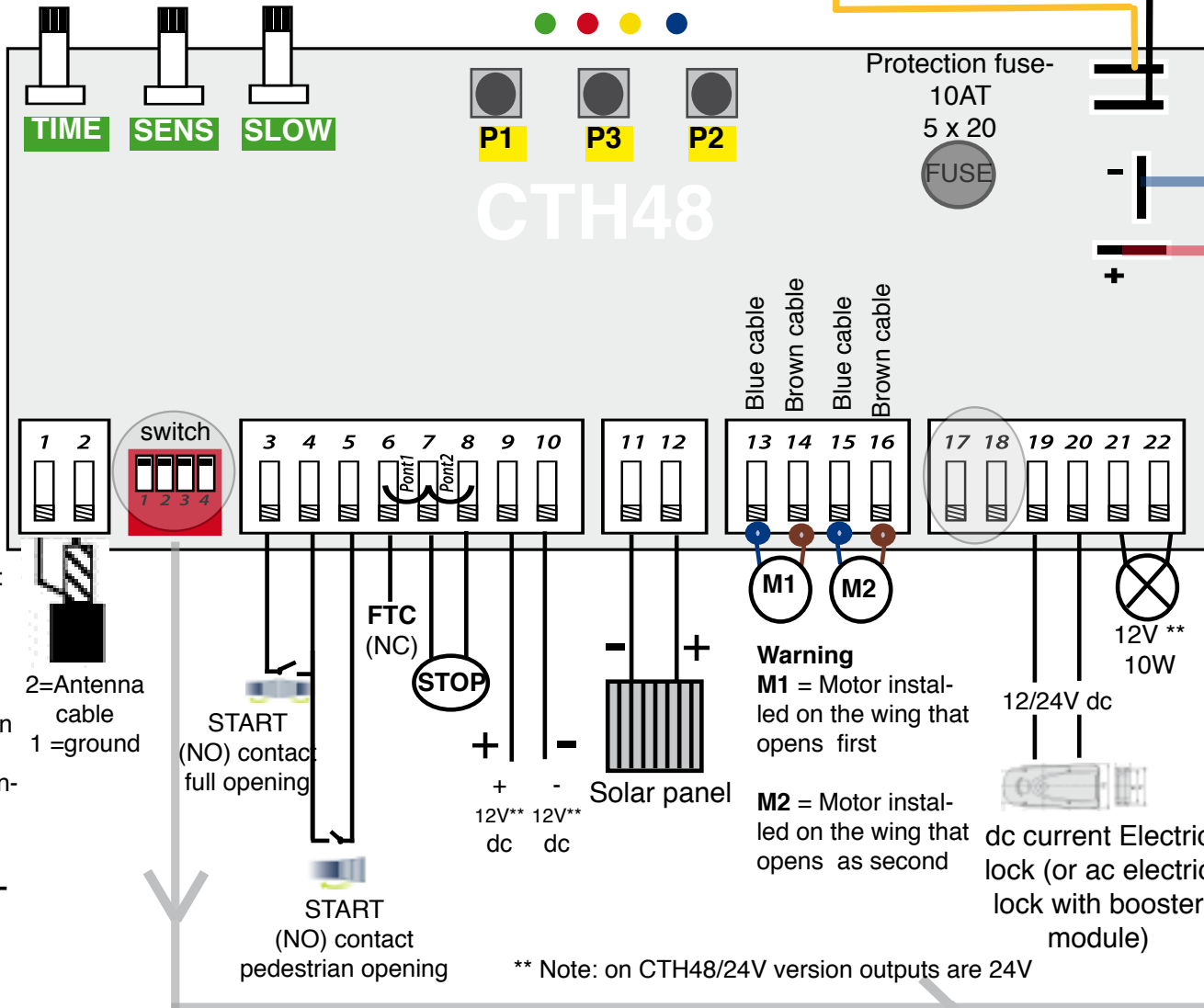

Protection Fuse 0,8 AT(1,2AT)



Main AC power supply 230V / (110V)

How to wire the toroidal transformer:

CTH48 (12V):

use 12V (yellow/orange) cable and 0 = black cable

CTH48/24V:

use the 24V red cable and 0 = black cable

Protection fuse-

10AT

5 x 20

FUSE



Battery

Battery cables /connectors
CTH48 12V = battery 12V min.7A

CTH48 24V = 2 x battery 12V min.7A in series connected
Respect polarity:
+ = positive / - negative

It is mandatory that the electric lock is equipped with a "booster" which converts the 12/24Vdc output voltage of the CTh48 electronic board into 12V ac (standard electric lock's power supply)

Warning

M1 = Motor installed on the wing that opens first

M2 = Motor installed on the wing that opens as second

12V ** 10W
12/24V dc
dc current Electric lock (or ac electric lock with booster module)

** Note: on CTH48/24V version outputs are 24V

switch

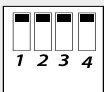

SWITCH N° 1 in **ON** (upper position) = use on 2 wings gate



SWITCH N° 1 in **OFF** (lower position) = use on 1 wing gate

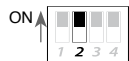

SWITCH N° 2 in **ON** (upper position) = soft stop will be deactivated and the gate will work only at 1 speed



SWITCH N° 2 in **OFF** (lower position) = Activate the SOFT STOP function

Note: the soft stop (deceleration) beginning point can be adjusted: by turning the trimmer T3, clockwise it delays the beginning of the deceleration.
Warning: in the first phase (at standard speed) in case of obstacle detection the direction is inverted, while during the second phase (blue LED lights) in case of obstacle detection, the movement is stopped (the gate will stop reaching the mechanical end limit).

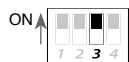

SWITCH 3 in **ON** (upper position) only if combined with automatic closure (potentiometer T1 must have been turned clockwise to activate the automatic closure function) will enable:

- any impulse/ command (by remote control or wired keyswitch) during the automatic closing operation, will stop and re-open of the gate
- any impulse/ command (by remote control or wired keyswitch) during the timerized pause time (while gate is open), will increase the dwell time for a time equivalent to that programmed.
- maintaining closed the "START" NO contact (for example by connecting a braker), the gate will stay open any command

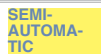

SWITCH 3 in **OFF** (lower position), only if combined with automatic closure (potentiometer T1 must have been turned clockwise to activate the automatic closure function) will enable activates the SEMI-AUTOMATIC MODE (or also called ANTI-THIEF MODE)

The opener will accepts impulses (by remote control or wired keyswitch) during the dwell pause phase, anticipating the closure of the gate. during closure manoeuver an impulse will produces the sequence: STOP-REVERSE OPERATION



SWITCH 4 in **ON** (upper position): active courtesy light / garden light lighting time 20sec. you have 2 options of use:

- A1)** NO dry contact becomes NC to activate a small 12V bulb max.10W
- B1)** a relay for any lighting system of higher power. 12V 10W max output terminals 17-18

A1) courtesy light 12V max 10W

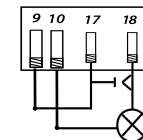

B1) Garden Light powered by 220/110V /110V

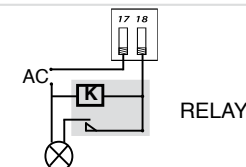

SWITCH 4 in **OFF** (lower position) ***activate the remote indication of the gate status .

A2) by wiring a LED lamp for example, you can remotely monitor the gate status: open = light on, slow flashing = opening, quick flashing = closing; off = gate closed. Output 12V max 10W lamp to be connected to terminals 17 -18

B2) to get the remote gate status signal and an additional command to keep the gate open by 3 wires only follow this instructions:

- (warning: this is possible only with automatic closure mode = potentiometer T1 turned clockwise and switch n° 3 on ON position)
- 1-connect terminal 9 to terminal 17
- 2- connect 3 wires to terminals 3-4-18
- 3- By closing contact between terminal 3 & 4 you will open the gate (connect a switch)
- 4- Buy holding the contact between terminals 3 & 4 closed the gate will be kept open (connect a braker)
- 5- *** connecting terminals 4 & 18 to a 12V max 10W lamp you will get the remote indication of the gate status .

A2) remote gate status signal

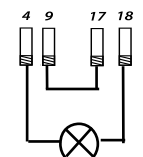

remote gate status signal
12V max 10W lamp

B2) ONLY 3 wires to get remote gate status signal and a wired command to keep the gate open

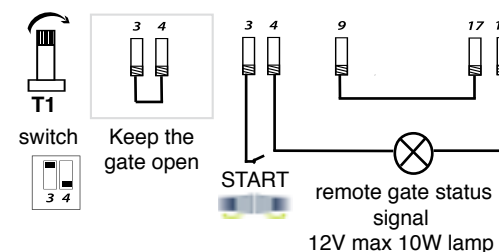

switch T1

Keep the gate open

START

remote gate status signal
12V max 10W lamp



WARNING ! All settings have to be made with gate in closed
WARNING ! In case the system is powered by solar panel and not from AC mainpower supply, make sure the battery is fully charged

CTH48 Wiring instructions

1 Antenna ground
 2 Antenna cable
3/4 START: NO (normally open) contact to command a full opening cycle
4 = Common/ ground (for both full Start and pedestrian start
4/5 PEDESTRIAN OPENING START: NO (normally open) contact to command a pedestrian access cycle (only 1 wing (M1) will partially open.
6 FTC safety infrared photocells NC (normally closed) contact (during closure phase if the infrared light is interrupted by an obstacle, the contact connectors 6-7 is opened and the gate will re-open. The gate will close only once the contact 6-7 is closed)
7 Common/ ground (for both Photocells and emergency stop contacts)
8 STOP: emergency gate stop command. NC (normally closed) contact
9 + 12V dc positive power output (photocells or any device max 0,5A)
10 - 12V dc negative power output (photocells or any device max 0,5A)
11 -12V dc negative power input from solar panel
12 + 12V dc positive power input from solar panel
13 M1 motor (actuator) **blue cable** (M1=motor that opens first)
14 M1 motor (actuator) **brown cable** (M1=motor that opens first)
15 M2 motor (actuator) **blue cable** (M2=motor that opens as second)
16 M2 motor (actuator) **brown cable** (M2=motor that opens as second)
17/18 2 possible uses:
 A) with switch N ° 4 in ON position, connect a timerized garden light
 B) with switch N ° 4 in OFF position, connect a light (12V max 10W) to be used as remote warning light of the gate status. Light on = gate open; light off = gate closed; blinks quickly by closing gate; slowly by opening gate
19/20 Electric lock 12V dc output (warning: ac electric lock require additional booster to transfor dc current into ac current)
21/22 Blinking light 12V 10W max
Battery Connectors (+/-) = connect directly to a back-up battery respect polarity: += positive / - = negative
POWER SUPPLY FROM transformer:
 CTH48 12V: connect to the power supply connectors on the back of the board the wires : cable Black(0) + cable yellow /orange(12V) from transformer. No polarity to be respected.
 CTH48 24V: connect to the power supply connectors on the back of the board the wires : cable Black(0) + cable red (24V) from transformer. No polarity to be respected.

CAUTION: we recommend to test the system fist avoiding immediate installation of infrared safety system. Only after having tested the gate opener works correctly you can add additional complementary accessories as the infrared safety system.

CAUTION: if you power the system by solar panel, in order to reduce the energetical absorbtion, we recommend to use reduced consumption photocells model SW7120 / LASER7120 or LASER 100



Warning: If you do not connect any photocell (infrared safety sensor) keep the **FTC** photocell infrared contact closed by the supplied electric bridge placed on connectors **6 & 7 (NC= Normally closed contact)**. If the contact gets open and no photocells are wired the gate opener will open but not close.

PHOTOCELLS - FTC Contact how it works:

photocells are optional safety devices that are active only in the closing cycle of the gate. Interrupting the infrared beam during the closing maneuver will result in reverse and immediate reopening of the gate.



Warning: If you do not connect any Emergency STOP button keep the contact closed with the supplied electric bridge placed on connectors **7 & 8 (NC= Normally closed contac)**.

If the contact gets open and no the gate opener will stop working.

CAUTION: M1 = Motor installed on the wing that opens first

M2 = Motor installed on the wing that opens as second

CAUTION: use on single wing gate: wire the motor as M1

CAUTION:: use on gates opening towards outside (push-to-open)

You must reverse motor cable polarity (reverse blue-brown cable for M1 and same for M2)

PUSH BUTTONS

P1 = **FULL OPENING CYCLE.** Push button to store or cancel the radio transmitters (FOB) codes on the electronic board. This button is used to memorize a remote control button used to command full opening cycles.

P2 = **PEDESTRIAN ACCESS CYCLE.** Push button to store the radio transmitters (FOB) codes on the electronic board. This button is used to memorize a remote control button used to com-mand pedestrian opening cycles only. M1 actuator's gate wing will partially open to limit the access to pedestrians only.

P3 = **PHASE SHIFT ADJUSTMENT** push button to adjust the time lag delay displacement between M1 and M2. The adjustment varies the delay time between the leaf M1 and the leaf M2 during the closing phase. The phase shift time remains unchanged during opening. To prevent the doors from overlapping incorrectly a longer phase shift time is necessary when the leaf corresponding to the motor M2 has to travel a greater opening angle than the other wing.

LED- warnings:

Green LED

- steady on=: power supply by AC main power supply
- slow blinking: power supply by battery

Red LED

- on after having pressed P1 button = remote control learning mode is activated
- blinking by open gate = gate open by step by step working mode
- steady on by open gate = gate open by automatic closure working mode.
- continuously blinking = by battery power supply the power is lower than 10,5V

Yellow LED

- blinking = by battery power supply the power is lower than 11,5 V.

Blue LED:

- during a manoeuver = lights up during the second phase (deceleration phase)
- switch on by pressing P3 button= phase shift adjustment mode is activated



WARNING !

CTH48 electronic board divides the movement of the gate in **two phases**: **in the first phase**, at normal speed, in case of obstacle detection, **the gate reverses** the direction of travel. **In the second phase** (=blue LED lights) speed will slow down (SOFT STOP) and during this phase in case of obstacle detection, **the gate stops**. Make sure the gates enter in the second phase before the gate reaches the mechanical end limits.

POTENTIOMETERS (trimmers)



WARNING !

We recommend the following settings for the first installation to test the system: Start with the potentiometers positioned as follows:
 trimmer TIME: turned counterclockwise
 trimmer SENS: turned clockwise
 trimmer SLOW: turned counterclockwise

Trimmer 1 (TIME) potentiometer to set the working mode:

- **“step by step” working mode**

Rotating the potentiometer counterclockwise to position “0” you set the “step by step” working mode. In this mode one impulse makes the gate open. the gate will stop by amperometrical obstacle detection. One impulse make the gate close. During opening manoeuver it is not possible to stop the gate by wired or remote controlled command. During closure manoeuver one impulse will stop and re-open the gate.

- **“automatic closure” working mode**

Rotating the potentiometer clockwise you set the pause time before the the automatic closure of the gate. Rotating clockwise the increases the pause timeup to 100 seconds. During opening manoeuver and during pause time the gate will not accept

any command. the gate will automatically close after the setted pause time. You can set additional functionalities by changing Switch 3 position

Trimmer 2 (SENS)

This potentiometer is used to adjust motor power and sensitivity levels in case of obstacle detection. In position = 0 (trimmer turned completely counterclockwise) = minimal power and high sensitivity in case of obstacle detection. **Turning the trimmer clockwise reduces the sensitivity and increases motor power.** It is recommended to reduce the sensitivity in case of wind gusts or heavy gate. Note: the adjustment sets the levels of the secon phase of the manoeuver (SOFT STOP) only.

Trimmer 3 (SLOW)

Regulates the starting moment of the second phase of the manoeuver (SOFT STOP). The CTH48 electronics divide each manoeuver into two phases:

first phase: motor starts at standard speed and in case of obstacle detection the travel direction is reversed.

second phase: at reduced speed (SOFT STOP) and in case of obstacle detection the gate stops.

The beginning of the second phase starts after 7 seconds from the beginning of the maneuver. By turning potentiometer “SLOW” you can adjust and delay the beginning of the second phase. Turn clockwise to posticipate the beginning of second phase.



It's very important that the mechanical end limit is reached during the second phase. In case of uncorrect adjustment the gate might reach the end limits during the first phase and this will produce the gate reverting the travel direction instead of stopping on the end limits. **Turn potentiometer counterclockwise to anticipate second phase** (SOFT STOP) beginning.

Caution: Even if you can deactivate the speed slow down (SOFT STOP) by setting Switch nà 2 in On position, the electronics will always keep dividing the manoeuver in 2 phases. It is therefore mandatory that the 2° phase begins before the gate reaches the mechanical end limit.

WIRED COMMANDS:

START: by wiring a bistable NO switch to connectors 3 & 4 you can command the full opening cycle by a wired command (key switch/ intercom button, or any additional additional button) both wings will open and both wings will close.

START PEDESTRIAN: by wiring a bistable NO switch to connectors 4 & 5 you can command the pedestrian opening cycle (M1 actuator's gate wing will partially open to limit the access to pedestrians only).

REMOTE CONTROLS (FOB)

Warning: control board model CTH48 can storage up to 20 ducati rolling coded remote controls buttons. In case you need to use more than 20 remote controls, you can purchase an extra (optional) Ducati radio receiver (RIXY6040 or RIXY 6043). Warning: only original ducati rolling coded remote controls are compatible.

A-1) How to memorize a remote control button in the control board memory to command a FULL OPENING CYCLE (on 2 wings gate both wings will open and both wings will close/ on 1 wing gate the gate will fully open)

Warning: Gate must be closed and idle (check the RED LED is switched off).

- 1) on the main electronic board press push button **P1**
 - the red LED will switch on (to confirm you entered the learning mode)
- 2) release **P1**
- 3) Press the remote control button you want to use to operate your gate. Hold the remote control button pressed for at least 3-4 seconds
 - once the main electronic board has stored the remote control the main control's board red LED will blink shortly to confirm remote control button has been stored. Wait for the main board's red LED to switch off.
- 4) You can now use the stored remote control's button to command your gate manoeuver. (Same remote control's button will operate both opening and closing of your gate). Repeat this operation for all desired remote controls.

A-2) How to memorize a remote control button in the control board memory to command a PEDESTRIAN OPENING CYCLE

as above point A1, but using P2 instead of P1

B) How to erase all remote controls from the memory of your control board

If the electronic board's memory is full or if a remote control is lost, it is possible to erase the stored remotes controls from the memory of the electronic board (attention this process leads to a total loss of memory).

Thereafter, the remote controls must be re-stored on the board.

Warning: Gate must be closed and idle.

- 1) on the main electronic board press push button **P1** and hold it pushed for about 30 seconds until the red LED blinks to confirm all memory has been deleted
- 2) release **P1**

Memorize again the remaining remotes you want to use by following instructions as in point A) here above. Repeat the procedure for each remote control

Um neu zu programmieren die Schritte vom Punkt A von 1-4 befolgen.

TIME SHIFT ADJUSTMENT (between 2 wings)

This function allow to adjust the 2 wings automatic pause shift.

Standard setting: M1 starts to open, and M2 starts to open about 4 seconds after M1 and Vice Versa during closure manoeuver.

The adjustment varies the delay time between the leaf M1 and the leaf M2 during the closing phase.

The phase shift time remains unchanged during opening.

To prevent the doors from overlapping during the closing phase, a longer phase shift time is necessary when the leaf corresponding to the motor M2 (the one that closes as first one) has to travel a greater opening angle than the other wing (the one that closed as second one).

The adjustment is required only if the M2 gate wing needs to open with an opening angle greater than M1's Gate wing

P3 = push and release P3 to enter the phase shift adjustment. the blue LED lights up.

Within 5 seconds:

- Press P1 to increase the shift time. The green LED will switch on at each impulse.
- Press P2 to reduce the shift time. The yellow LED will switch on at each impulse.

Each impulse corresponds to 0,5 seconds increase/ reduction of shift time.

By reaching the minimal/ maximal adjustment the red LED will switch ON to warn you that the limit has been reached.

As you have entered the desired adjustment, wait 5 seconds without pressing any button to confirm the selection.

Power supply by emergency back-up battery

Use a fully charged 12V min.7A battery

Use the 2 wires welded to the backside of the control board CTH44 to connect the battery to the board.

WARNING: respect cable polarity red cable= battery positive pole (+); blue cable = battery negative pole (-)

In case of main ac power supply failure, the back-up battery will ensure autonomous use for up to 4 days.

Power supply by Solar panel and battery: 100% autonomous use

Use a fully charged 12V min.7A battery

Use the 2 wires welded to the backside of the control board CTH44 to connect the battery to the board.



WARNING: respect cable polarity red cable= battery positive pole (+); blue cable = battery negative pole (-)

Connect a 12V min.10W solar panel to the board CTH44 by means of bipolar (outdoor use min. 0,5mmq cable) with the utmost attention to the polarity of the terminals:

connector n° 11 - solar panel negative

connector n° 12 + solar panel positive

The solar module should be directed towards the south (see also notes installation and positioning) and in a well-lit place. Avoid shadow zones, which reduce the load capacity considerably.

It is recommended to install the solar panel not over 10-15 meters from the electronic board to prevent unnecessary electrical losses.

The following table shows an estimated calculation of the autonomy in non-ideal weather conditions (winter cloudy weather) by use of a 10W solar panel and 7A battery.

The autonomy increases in case of use of to larger capacity battery (ex. 12V 12A) and larger solar module (ex. 12V 20W). Instead of using a larger solar module, on CTH44 it is possible to add a second solar panel to increase the charge capacity.



WARNING: by increasing the watt of the solar module, the battery capacity must also be increased.

For example: if using 20W 12V solar panel requires a 12V min 12V battery.



NOTE: you can also wire main ac power supply through a switch. The AC power supply can be switched on to recharge the battery in case of needs, DO not power the board by both solar panel and AC power supply at same time.

TABLE-	GATE	Stand-by consumption (A)	daily consumption	Consumption for a complete cycle (open+ close), (A)	Suumption of total n° of daily cycles (open+close)	total daily consumption (A)	average charge of a 10W 12V solar panel (A /hour) in non ideal weather	hypotesis of lixght exposure (hours/per day)	Total recharge capacity (A)	balance between consumption and recharge
Board CTH48	1 wing	0,007	0,16	0,012	60	0,88	0,3*	5	1,5	+ 0,62
	2 wings			0,024	50	1,36				+ 0,14



6203R 6203P 6204 6202 6208



■ **Model 6203 ROL = 2 buttons rolling coded remote control. Blue with blue button FOB.**

Battery: 1 x 12V C-23A

■ **Model 6203 P = 2 buttons rolling coded remote control. Blue with red button FOB.**

Battery: 1 x 12V C-23A gespeist

■ **Model 6202 = small 2 buttons rolling coded remote control. in blue, yellow, red, black color available.**

Battery: 2 x CR2016 3V

■ **Model 6208 = small 4 buttons rolling coded remote control. white/black color FOB**

Battery: 2 x CR2016 3V

■ **Model 6204 = small 4 buttons rolling coded remote control. black color FOB**

Battery: 1 x 27A 12V gespeist

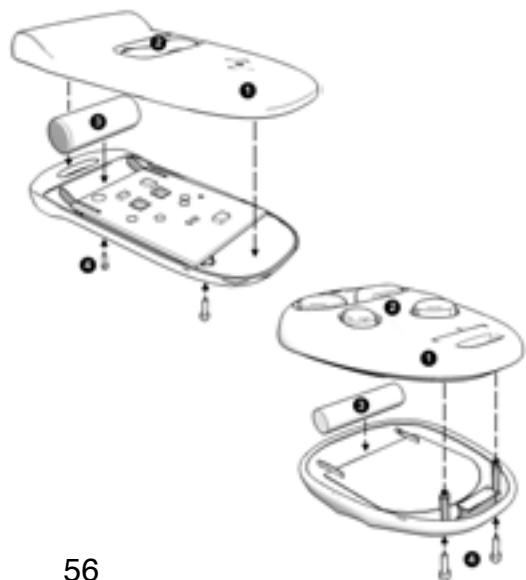

The DUCATI radio rolling coded transmitters (FOB), featuring a unique “rolling code” radio protocol are compatible with all Ducati rolling coded openers (CTH electronic boards). With over 3 billions of continuously changing combinations, they ensure maximum protection against radio interferences. Frequency: 433,92MHz

Any of the rolling coded remote controls is compatible with all models of rolling coded Ducati’s openers. You can combine and use different remote control model on the same opener

Each transmitter button is factory programmed with a unique code. Ducati’s rolling code remote control cannot be cloned.

Each button on the remote control can be used to operate a different function (for example tone button to command full opening cycle, and second button to command pedestrian opening cycle) or different openers (for example one button to command your gate opener and the second button to command a garage door opener

Warning: The memory of the control board of your opener can store up to 10-20 codes depending on the model (check the maximal storage capacity of your electronic board). If you need a larger number of remote controls you can purchase an optional external receiver (RIXY6040 o RIXI 6043). The external receiver can be also used to command other brand automatic systems with a Ducati rolling coded remote control.

To operate your “DUCATI” opener with your DUCATI remote control you must memorize the remote control code on the electronic board of your opener. **WARNING:** Operate adjustments and settings only with garage door or gate in closed position.

A) How to memorize (store) the remote control code inside the electronic board of the opener for full opening cycle

The door must be closed and idle.

- Press button P1 on the electronic board. The red LED switches on.

- Release button P1 and immediately press on the buttons of the remote control that you wish to use to operate the device. Hold the remote button pressed for about 4 sec. - the LED light on the electronic board will quickly blink to show the procedure has been completed. Wait until the LED switches off.- Press again the memorized remote control button, the opener will start an manoeuvre

A2) How to memorize (store) the remote control code inside the electronic board of the opener for pedestrian opening cycle (only 1 wing will partially open)

Please check the specific instructions for each specific electronic board model.

to resume:

On board model CTH41: this feature is not available.

On board model CTH42: like the procedure at point A1, but use the **J1** button instead of the P1 button

On board model CTH44: follow the instructions of point A1, but instead of just pressing P1, press and hold **P1 and simultaneously press P2** and then release both buttons.

On board model CTH48: follow the instructions of point A1, but use the **P2** button instead of the P1 button

Warning: when opening your gate in pedestrian mode, the gate must be closed with pedestrian mode before to proceed with a full opening cycle command.

B) How to erase the codes from the control board (total loss of all previously stored remote controls)

To deactivate any unwanted remote, erase its memory from the electronic board of your opener as following (all remote control codes memorized will be delated):

- The door must be closed and idle.

- Press button P1 for about 30 sec. until the red LED blinks

- Release P1. All codes have been erased and the memory of your control board is ready to memorize new remote controls (follow instructions as on point A



- Radio rolling coded Keypad SW6500/TASTY 6500
Powered by battery model CR2450

VIDEO -MANUAL

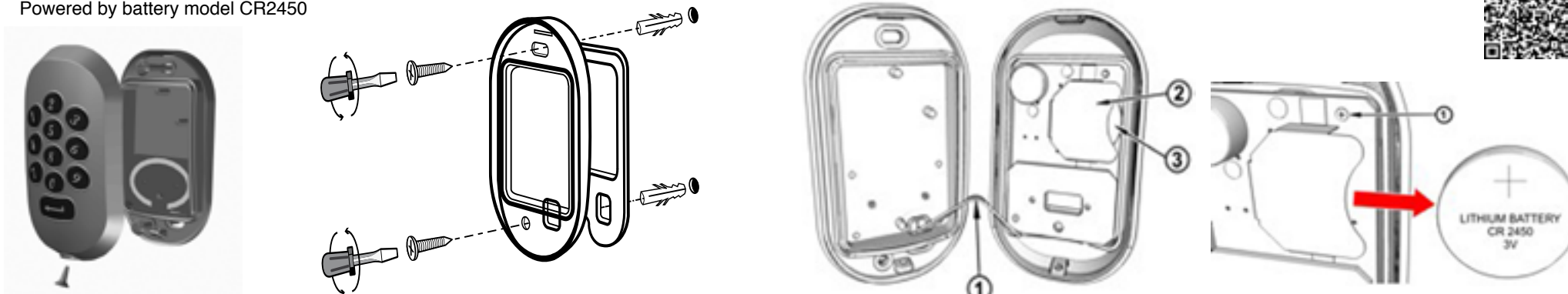

- The Radio keypad is a wireless remote control. Transmitting a unique Ducati rolling code, it allow to operate any rolling coded Ducati opener. Suitable for outdoor use. Fix the keyboard to a wall with a max. distance of 10 meters from the control unit of the opener. The transmission of the radio signal is protected by a personal code with 4 digits.

The keypad is supplied with a standard 4 digit code = 1111

To activate the radio transmission you must digit 1111 + "OK" button



WARNING: The standard code has to be replaced with a personalized code. On the keypad you can use up to 10 different 4 digit protection coded to unlock it. After a personalized code has been saved, it is advisable to note this down and keep it safe. The loss of the code makes the device unusable. If you loose your 4 digit code it will be necessary to send the keypad to the manufacturer to reset it.



WARNING if you digit 3 times an uncorrect 4 digit code the keypad will enter in protection mode, and will no longer accept any digit for 10 minutes. Wait 10 minutes and enter the code again correctly. If you loose your 4 digit code it will be necessary to send the keypad to the manufacturer to reset it.

1) How to replace the standard code with a personalized 4 digit code (first operation)

digit the standard code 1111 + 3 + the 4 digit of the choosen personal code + OK" button The keypad will make a BEEP to confirm that standard code has been replaced

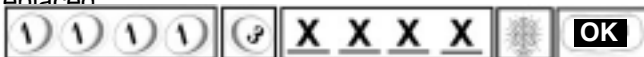

To make the keypad operate your ducati's gate opener you must memorize the radio transmission code inside the electronic board of the gate opener. To memorize the keypad onto your gate's emlectronic board, follow instruction as per any different remote control (see page 56).

2) To memorize the Keypad code in the electronic panel of the opener (to command fiull opening cycle) (see also page 56: remote control manual):

The door must be closed and idle.

- Press button P1 on the electronic board. The red LED switches on.
- Release button P1
- On the Keypad: **digit of the choosen personal code + OK" button** (hold OK button for about 1,5sec. at least) until the keypad confirms with a "beep".
- On the electronic board the red LED light will quickly blink to show the procedure has been completed succesfully.
- Wait until the red LED turns off. Now the personalized code of the keypad is stored in the control board of your gate opener.

WARNING: make sure to have digited the personal code and OK button while the control board is still in " remote control learning mode". If the radio signal is sended to late



the electronic board of your gate opener will not memorize it.

Warning: The memory of the electronic board of your opener can store up to 10-20 codes depending on the model (check the capacity of your memory card). If you need a larger number of remote controls is available an optional external receiver (RIXI6040 or RIXI 6043)

WARNING: Press the button of your code firmly and not too fast. The "OK" button must be pressed firmly until an acoustic signal appears.

2) How to replace a personal code with a new personal code:

digit the personal code you wish to be replaced + 4 + the four digits of the new personal code + "OK" button
The keypad will make a BEEP to confirm that the personal code has been replaced.

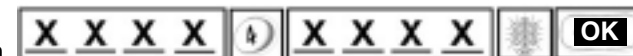

3) HOW to add a new 4 digit code (without delating the previously setted 4 digit codes):

digit one of the previously setted 4 digit codes+ 3 + the new 4 digit code + "OK" button

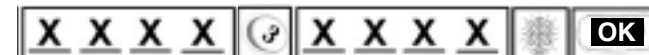

4) How to delate a specic 4-digit code from the keypad

digit the code you want to delate + 5 + "OK" button, the LED on the keypad will start blinking, press again on "OK" button (within 1,5sec.) and hold it pressed until the LED blinks, then release "OK" button.



5) How to delate all the codes setted in the keypad (all codes will be delated)

digit one of the previously setted 4 digit codes+ 6 + "OK" button,. The LED on the keypad will start blinking, press again "OK" button(within 1,5sec.) and hold pressed until the LED blinks, then release "OK" button.
The keypad will make a BEEP to confirm the procedure has been completed.



WARNING: the Keypad will go back to the standard code =1111 but with this standard code it will not be possible to command anymore the opener. It will be necessary to re-set a new personalized code following instructions of point 1 above.

B) To erase your KEYPAD from the control board of your opener:

To deactivate any unwanted remote, erase its memory from the electronic board of your opener as following (all remote control codes memorized will be delated):

- The door must be closed and idle.- Press button P1 for about 20 sec. until the red LED blinks - Release P1. - All remote control codes have been delated.

WARNING: all remotes controls previously stored in the control board of the gate opener will be delated.

- Reprogram each remote you wish to use following procedure on point 2 (see also page 56: remote control manual).

DUCATI Radio Keypad 4 channels TASTY 6504 / SW 6504

■ The 6504 wireless keypad has 4 transmission channels and can control up to 4 different Ducati rolling coded automation devices. The transmission of the radio signal is protected by a personal code with 4 digits. The 4 digits personal code remain the same for the 4 channels.

Follow same instructions as per the previous model 1 channel keypad but after digiting the 4-digit personalized code

+ "OK" push button, you have to also select the channel you want to use (from 1 to 4)

push the number of the cannel you choose to send the signal trough.

button n° 1 = channel 1; button n° 2 = channel 2; button n° 3 = channel 3; button n° 4 = channel 4;

Example:

If you want to use channel 1, you have to dial: your personal 4 digit code + "OK"button + 1

If you want to use channel 2, you have to dial: your personal 4 digit code + "OK"button + 2

If you want to use channel 3, you have to dial: your personal 4 digit code + "OK"button + 3

If you want to use channel 4, you have to dial: your personal 4 digit code + "OK"button + 4

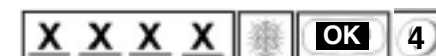
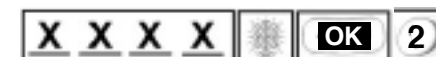

■ The flashing light is used as a visual warning of the presence of an automatic gate in motion. It must be installed on the pillar / wall and be clearly visible from inside and outside the property. The blinking is slow in opening and faster during closing. The installation of the flashing light is mandatory to ensure security on public transit area.

The flashing lights model: FLASH 7712; 7512, HC7500 / 12 use a 12V max 10W bulb

The flashing lights model: FLASH 7724; 7524 HC7500 / 24 use a light bulb max 10W 24V

An external aerial antenna (STILO 6025, wall mounting, or STILO 6023, to be installed on Flash blinker) can be added to replace the antenna cable supplied as standard on each electronic board, to improve the reception of the radiosignal. However it is advisable to limit the use of external antennas in case it is strictly necessary. The use of this device increases the vulnerability of the electronic board from electrostatic discharges during the storms that could damage the board. This type of damage is not covered by warranty. It is suggested to use of an external radio receiver (RIXI 6040 or RIXI 6043 instead of an external antenna).

■ SW/ FLASH Blinking light series

Wiring with no polarity to be respected

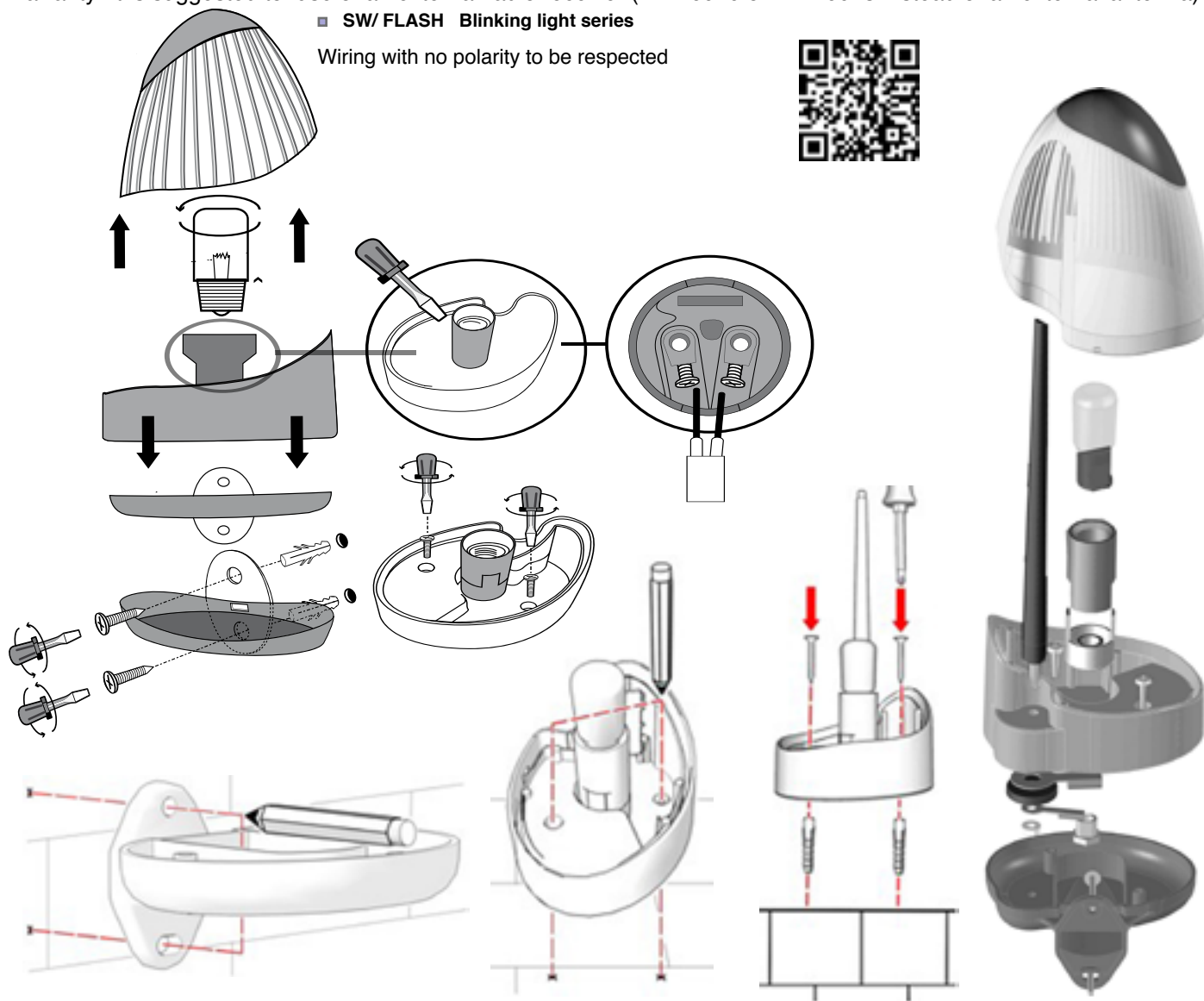

■ SW/ FLASH Blinking light with LED light circuit 12V/24V ac/dc

Wire to a ducati electronic board using the dc connectors. No polarity to be respected

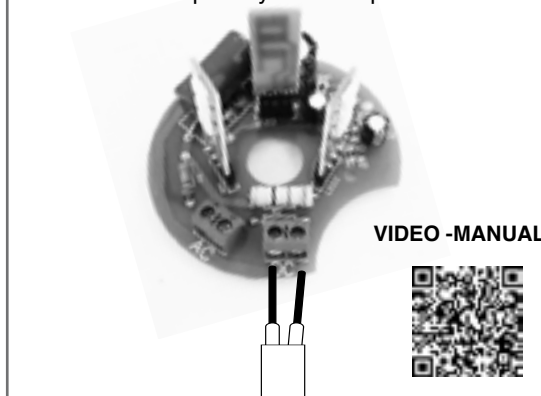

VIDEO -MANUAL



■ SW/ FLASH Blinking light with standard light bulb

No polarity to be respected

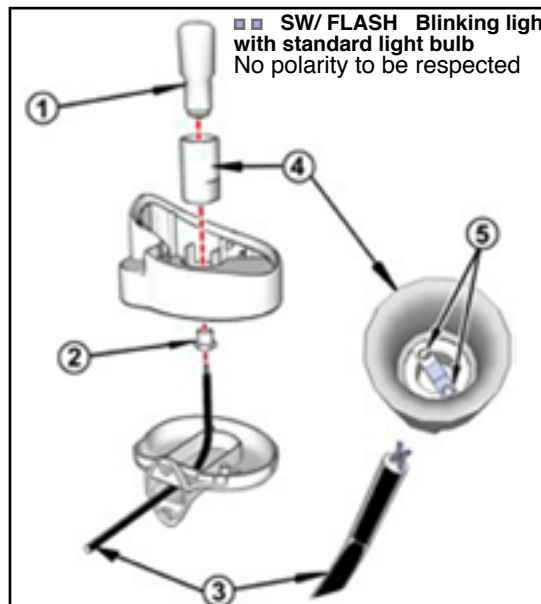



RIXY 6040 R

N° of channels: 4

Channels contact: normally open (NO)
Can select each channel to be stable or bistable

Each channel storage capacity: max.25 remote control's buttons

Radio frequency 433,92 MHz

Contact rating relay: 1A /30V

Working temperature: -10°C / + 60°C

Irradiation of antenna: in compliance with EU Norms

Stand-by Absorption: 0,008 A

The 4-channel DUCATI radio rolling code radio receiver can be used to increase the number of remote controls to be used to command a single DUCATI GATE OPENER or to control different functions/ devices with a Ducati rolling coded remote control. **You have up to 4 channels available: CH1; CH2; CH3; CH4.** Each channel allows you to manage a DUCATI openers or even any third party device with and command it with any of the DUCATI rolling coded remote controls (FOB) radio transmitters. Each channel has a storage capacity of 25 radio remote controls (FOB)

1) Wire the selected channel terminals to the desired device's connectors. Connect the output terminals of the channel on the radio receiver to the input terminals of the electronic board of the device you wish to control.

Example: if you want to use Channel 1 of the radio receiver to command the full cycle opening of your gate opener: connect terminals of CH1 to the START contact of the main board of your gate opener.

If you wish to use Channel 2 to command the pedestrian opening of your gate opener, connect terminals CH2 to the "PEDESTRIAN START" terminals of your gate opener. If you wish to control your garage door opener by Channel 3 connect terminals CH3 to the start terminals of your garage door opener. You can also connect the channels to a non third party device. This way you will be able to operate any device with the same Ducati rolling code remote control.

2) Power the radio receiver. Can be powered by any 12V/24V ac/dc power supply. You can power the Radio receiver by the 12V /24V power output (also sused to power the infrared safety sensors) from the gate opener main control board. There is no polarity to be respected.

3) Sycronize/ store the remote control button in the radio receiver:

Once the selected channel is wired to the electronic board of the main device you must store and memorize the push button of the remote control (FOB) you want to use in the corresponding channel othe external radio receiver.

On the radio receiver push the button corresponding to the channel you wish to store the remote control button in:

CH1 = channel n°1 = push P1 to enter remote control learning mode on channel n°1 then release the button

CH2 = channel n°2 = push P2 to enter remote control learning mode on channel n°2 then release the button

CH3 = channel n°3 = push P3 to enter remote control learning mode on channel n°3 then release the button

CH4 = channel n°4 = push P4 to enter remote control learning mode on channel n°4 then release the button

The red LED light On to confirm learning mode is activated.

Push, and hold pushed for 4 seconds the remote control button you want to store in the selected channel.

On the radio receiver The red LED light blinks to confirm that the remote control button has been stores successfully.

Repeat this procedure for each remote control button you want to store.

SWITCHES

Used to determinate if the channel is wanted as monostable or bistable contact (monostable contact refers to the momentary pulse as the oen used to command the opening of the gate, while stable refers to the maintained operation).

Each switch is used determinate the correspondent channel example: switch n° 1 is used for channel CH1.

Position the switch in OFF (lower position) for bistable contact.

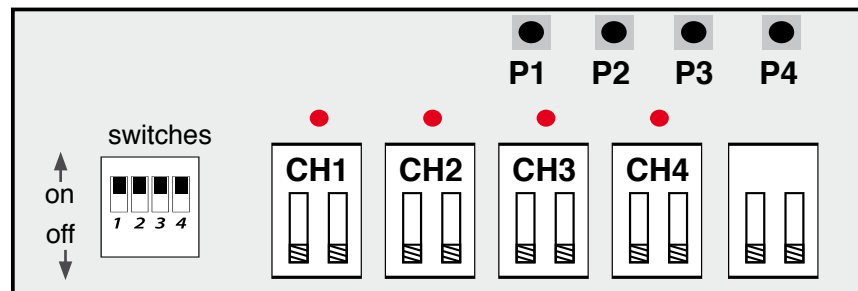
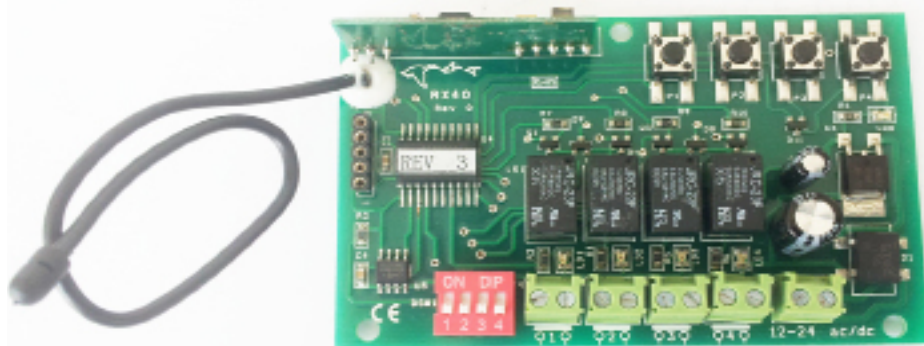

ON position = bistable contact;
OFF position = monostable contact

NO (normally open) contacts without polarization

Power supply input terminals. power by 12V/24V ac/dc no polarity to be respected



The 3-channel DUCATI radio rolling code radio receiver can be used to increase the number of remote controls to be used to command a single DUCATI GATE OPENER or to control different functions/ devices with a Ducati rolling coded remote control. **Each stored code is identified by a position number and indicated on the display.**

Total maximal storage capacity: 100 Ducati Rolling coded radio remote controls (FOB).

You have up to 3 channels available: CH1; CH2; CH3.

Channel CH3 is a bistable contact with memorization option (up to 6 minutes). It can be used, for example to switch on the garden lights with an automatic switch-off after a desired pause time that you can set by turning the potentiometer.

1) Power the radio receiver. Can be powered by any 12V/24V ac/dc power supply. You can power the Radio receiver by the 12V /24V power output (also used to power the infrared safety sensors) from the gate opener main control board.No polarity to be respected

WARNING: The display switches ON automatically by pressing any of the radioreceiver button or by receiving a previously stored radio signal. Side Switch to 1 position to switch it OFF, slide it to "ON" position to light it on

Warning:
SLIDE SWITCH to switch ON/OFF the display
ON = Display on
OFF (1) = display off

DISPLAY A shows the selected channel
1 = CH1
2 = CH2
3 = CH3

DISPLAY B shows the position number of the stored remote control (Max 100 total positions 00 to 99)

CH3 channel temporization adjustment up to 6 min.
turn fully counterclockwise to deactivate the timer, turn clockwise to increase timer up to 6 min.

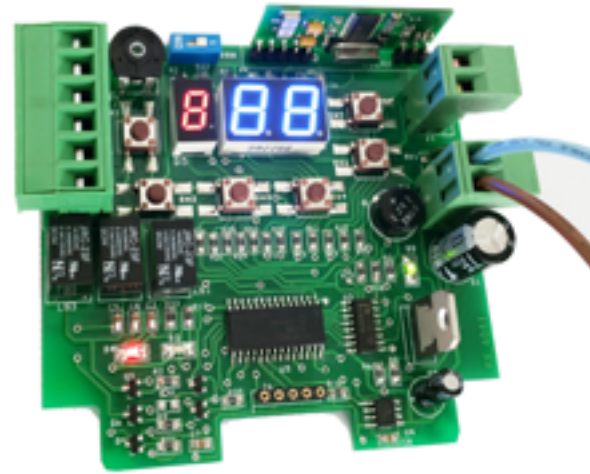
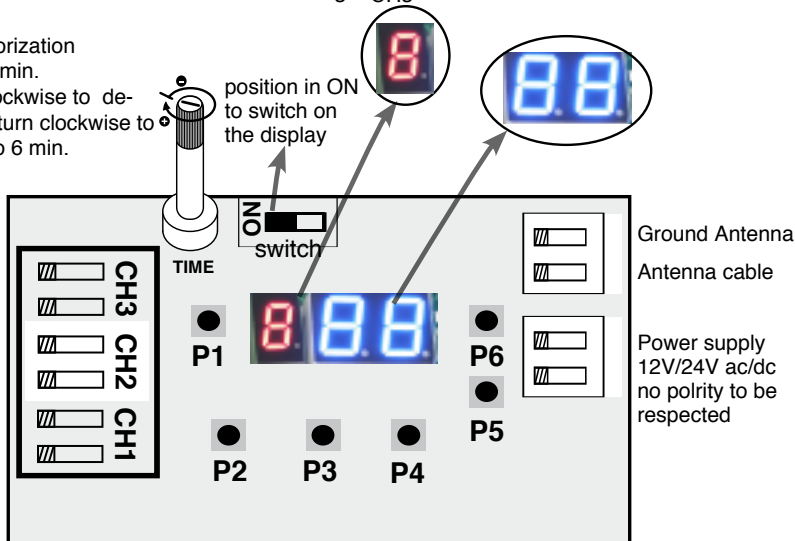

RIXY 6043

N° of channels: 3
Channel contact: normally open (NO)
Total storage capacity: max.100 remote control's buttons
Radio frequency 433,92 MHz
DUCATI rolling code system
Contact rating relay: 1A /30V
Working temperature: -10°C / + 60°C
Irradiation of antenna: in compliance with EU Norms
Stand-by Absorption: 0,008 A

First activation: light on the display by positioning the "switch" in ON position. The board starts a auto-test: "CC" will appear on the display if no remotes are stored in the receiver. Wait until the display turns off.

1. How to store/memorize a radio remote control button (FOB)

- Push P1, the display switches on.
- by pressing P6 you can choose the channel you will store the remote control button in
- Push the remote control's button you wish to store. and hold it pushed for at least 4 seconds. Display A will blink to confirm it has been correctly stored and displays the channel number on which the remote control button has been stored in. The B display shows the remote control's button corresponding stored position number. Example: if the displays show "2 03"= remote button has been stored in channel 2 at position 3
The red LED lights on simultaneously. Then the display turns off.

2. How to delate a specific previously stored radio remote code button

- Press P2. The A display will show "P", the B display will show: - -. release P2
- displays will now show: "P 00"
- Identify the position number you want to delate by pressing push button P6(increase) or P5 (decrease)
- Push again P2 and hold it pushed until the red LED light switches on. The position number witch is beeing delated is blinking on the display. Once the remote control is delated the display switches off. Release P2.

3. How to erase all stored codes

- Push and hold pushed P3 until the display shows: CC.
- Release P3. The process continues until the total erasure of the memory is ended and can not be interrupted.

DUCATI Keyswitch KEY 5000 / KEY 5005

■ Wired Key Switches: KEY 5000 / KEY 5005 / KEY 5005 INOX

Connect connectors 1 & 2 to the START normally open contact of any DUCATI electronic board to command a full cycle maneuver (both wings will operate a full cycle, or in case of single wing gate use, the single gate will operate a full cycle). There's no polarity to be respected.

Connect connectors 1 & 2 to the PEDESTRIAN START normally open contact of a DUCATI electronic board to command a partial pedestrian maneuver (only 1 wing will partially open to permit pedestrian access only) There's no polarity to be respected.

You can wire as many desired additional key switches or any additional different button to operate your gate opener, you can use any device with a clean N.O (normally open) bistable contact, wire them in parallel. For extra safety it is advisable to wall up the wiring cables.

■ KEY 5005

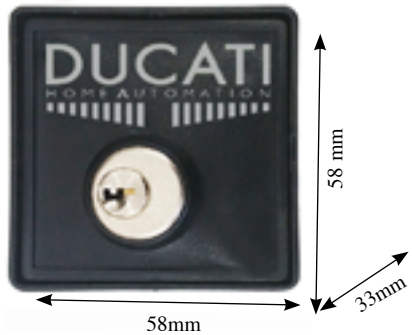

■ KEY 5005 INOX

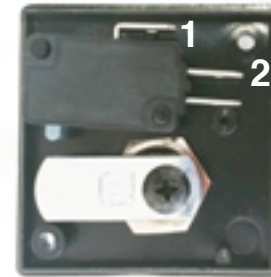

■ KEY 5000

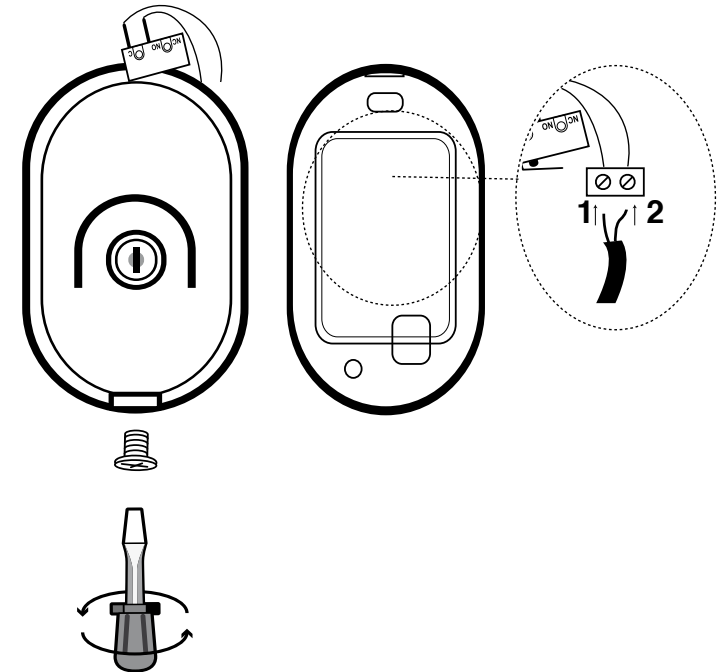
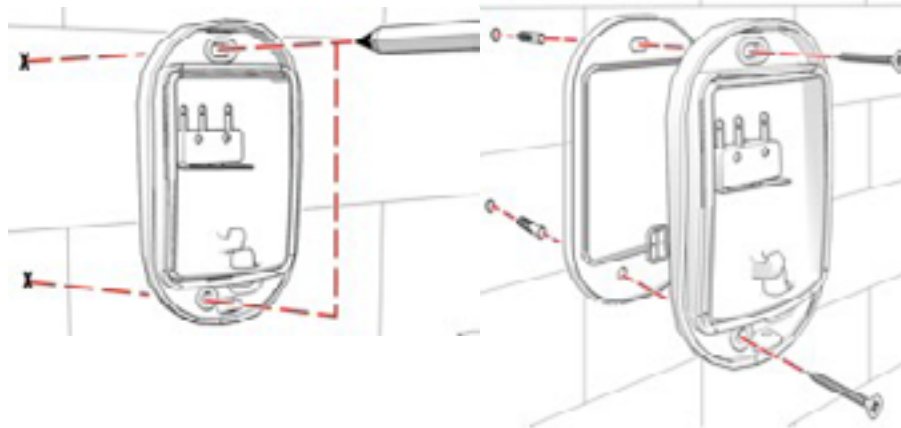
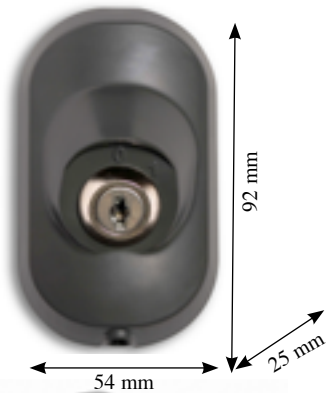



- Infrared safety sensors are a complementary safety device to prevent persons or vehicles from trespassing a gate driveway to be touched from a gate while it is closing. One pair of photocells consists of a transmitter (TX) and its receiver (RX). The TX transmitter emits a modulated infrared light beam received by the receiver RX. If this invisible light beam is interrupted a signal is sent to the electronic board.

Transmitter and Receiver must be installed on side posts or walls and be correctly aligned. While the infrared beam is received by the photocell receiver, the NC (normally closed) contact on the gate opener control board is kept closed. Photocells are not active while the gate is opening.

Should a person, pet, or vehicle break the beam, while the gate is closing, the gate will immediately stop and reverse.

While the contact is kept open the gate will no longer close until the infrared beam alignment is restored and the contact kept closed.

Photocells should not be installed more than 10 meters distance

It is recommended to install the photocells at about 60cm high from the ground in order to easily detect a trespassing vehicle, pet or person.

They can be installed inside or outside of the property on the sides of the gate, directly on gates posts or on small columns in a position where the opening and closing operation of the gate does not interfere with their effectiveness.

It is possible to install as many pairs of photocells as desired. The connection must be made in series.

It is recommended to avoid to use at same time SW7120 or LASER7120 with different photocell models if more pairs are installed on the same device. This could create wiring confusion as model 7120 has a specific and unique wiring diagram.



WARNING: Photocells models featuring a NO (normally open) contact, can be mounted inside the property and connected to the “START” connectors of any gate opener to be used as opening command of the gate. Be aware that this type of use could be dangerous if children or pets are left alone in the gate’s area as they could command an unwanted opening maneuver. When

List of Photocells Models:

SW 7012.....standard universal 12V/24V ac/dc pair of infrared sensors with NC contact

LASER 7012.....stainless steel cover universal 12V/24V ac/dc pair of infrared sensors with NC contact

SW 7120.....reduced consumption universal 12V/24V ac/dc pair of infrared sensors with NC contact

LASER 7120..... stainless steel reduced consumption universal 12V/24V ac/dc pair of infrared sensors with NC contact

LASER 100.....standard universal 12V/24V ac/dc pair of infrared sensors with NC contact + NO contact

LASER 100/B...standard universal 12V/24V ac/dc pair of infrared sensors with NC contact or NO contact

LASER 200..... 90° rotating eyes standard universal 12V/24V ac/dc pair of infrared sensors with NC contact + NO contact



WARNING : photocells model SW7012 and SW7120, as well as model LASER7012 and LASER7120 are aesthetically identical.

They shall be identified and distinguished by the part number written on the PCB (printed circuit board) of the receiver. To check it unscrew the inner cover that protects the PCB and read the correct part number. Caution: with CTH44 and CTH48 electronic boards powered by the solar panel is indispensable use of photocells model 7120 in order to contain the consumption of the system. It is advisable, in such cases, to install a single pair of photocells.

Model 7012 standard universal 12V/24V ac/dc pair of infrared sensors with NC contact.

Unscrew the front cover to fix the photocells on the wall/post. Use an outdoor use a 2 wires 0,3-0,5mmq cable to power the Photocell transmitter (TX).

Use an outdoor use 4 wires 0,3-0,5mmq cable to power the Photocell receiver (RX).

Transmitter and receiver should not be installed at more than 10 m from each other. Make sure they are correctly aligned.

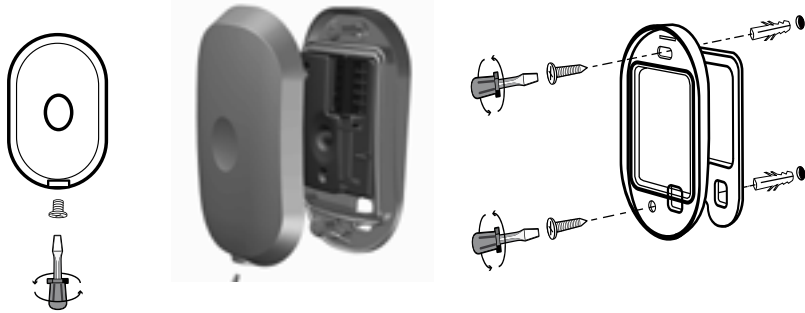

Wiring of 1 pair of photocells model 7012

Transmitter TX
(photocel model 7012)

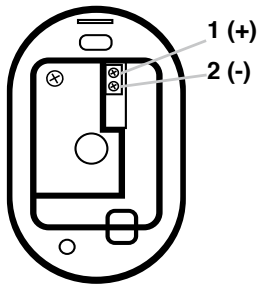

Receiver RX
(photocel model 7012)

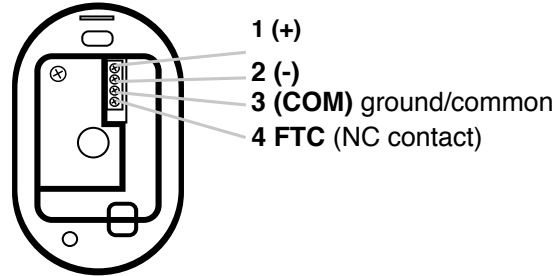

- 1 = + positive power supply 12/24V ac/dc
- 2 = - negative power supply 12/24V ac/dc
- 3 = COM ground/common.
- 4 = FTC NC (normally closed) photocell contact

WARNING by connecting the photocells to the electronic board, you must remove the bridge which keeps the photocell contact closed.

In series wiring of 2 pairs of photocells model 7012

Transmitters TX
(photocel model 7012)

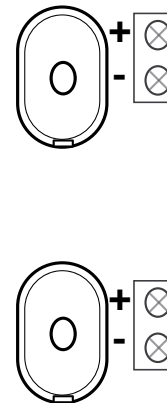

Receives RX
(photocel model 7012)

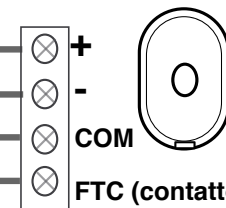
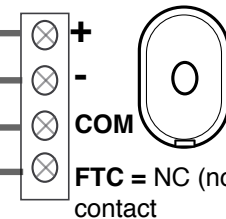

COM + - FTC

Model 7120 reduced consumption universal 12V/24V ac/dc pair of infrared sensors with NC contact.

Unscrew the front cover to fix the photocells on the wall/post. Use an outdoor use a 2 wires 0,3-0,5mmq cable to power the Photocell transmitter (TX).

Use an outdoor use 3 wires 0,3-0,5mmq cable to power the Photocell receiver (RX).

Transmitter and receiver should not be installed at more than 10 m from each other. Make sure they are correctly aligned.

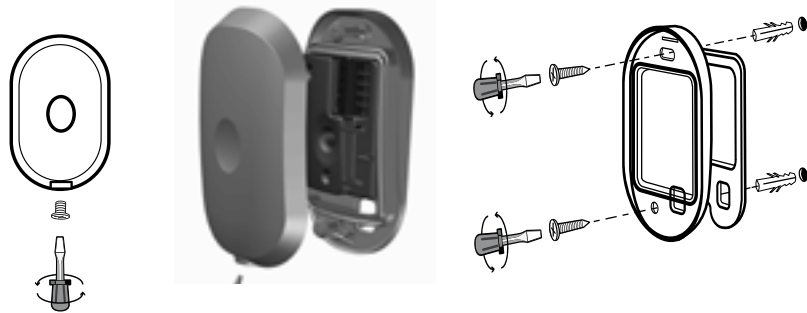

Wiring of 1 pair of photocells model 7120

Transmitter TX
(photocel model 7120)

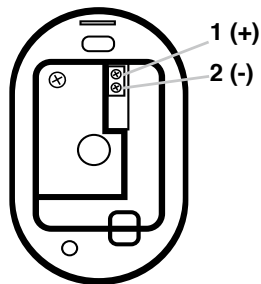

Receiver RX
(photocel model 7120)

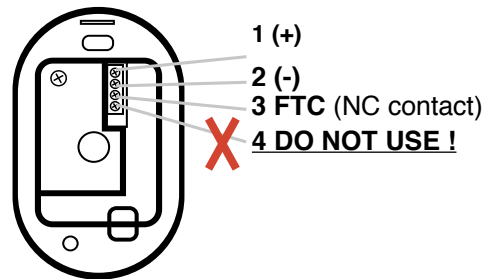

- 1 = + positive power supply 12/24V ac/dc
- 2 = - negative power supply 12/24V ac/dc
- 3 = FTC NC (normally closed) photocell contact .
- 4 = DO NOT WIRE THE CONNECTOR N° 4!**

WARNING by connecting the photocells to the electronic board, you must remove the bridge which keeps the photocell contact closed.

In series wiring of 2 pairs of photocells model 7120

Transmitters TX
(photocel model 7012)

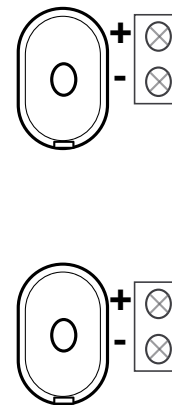

Receives RX
(photocel model 7012)

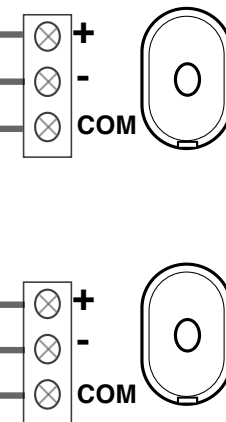

FTC + -

LASER 100 Standard reduced consumption universal 12V/24V ac/dc pair of infrared sensors with NC contact + NO contact

LASER 100B Standard reduced consumption universal 12V/24V ac/dc pair of infrared sensors with NC contact / NO contact

LASER 200 Standard reduced consumption universal 12V/24V ac/dc pair of infrared sensors with NC contact + NO contact.

Photocell eye can be rotated 90°

Unscrew the front cover to fix the photocells on the wall/post. Use an outdoor use a 2 wires

0,3-0,5mmq cable to power the Photocell transmitter (TX).

Use an outdoor use 4 wires 0,3-0,5mmq cable to power the Photocell receiver (RX).

Transmitter and receiver should not be installed at more than 10 m from each other.

Make sure they are correctly aligned.

Use the Photocells as safety device:

power the photocells (connectors 1 & 2) + Wire connector n° 4 (COM) and N° 5= FTC (NC) contact to the electronic bord of the device. Do not wire connector n° 3 (NO contact)

Should a person, pet, or vehicle break the beam, while the gate is closing, the gate will immediately stop and reverse. While the contact is kept open the gate will no longer close until the infrared beam alignment is restored and the contact kept closed.

Use the Photocells as gate opening command:

power the photocells (connectors 1 & 2) + Wire connector n° 4 (COM) and connector with NO contact (n° 3 on LASER 100 and N°4 on LASER 200) to the START connectors of the electronic bord of the device.

Should a person, pet, or vehicle break the beam, the gate will start an opening cycle.

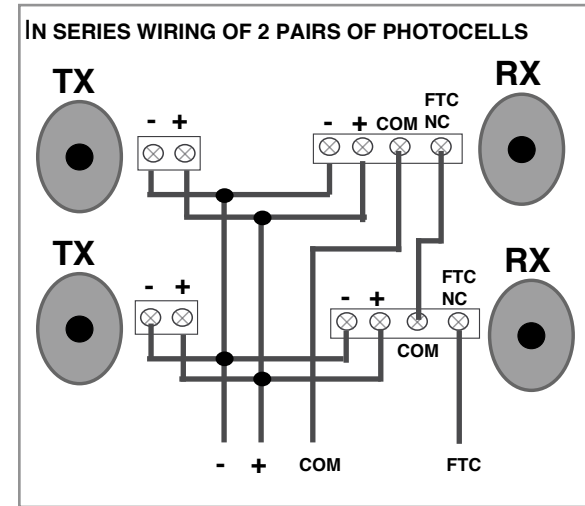

LASER 100

Wiring:

- 1 = - negative power supply 12/24V ac/dc
- 2 = + positive power supply 12/24V ac/dc
- 3 = START NO (normally open) contact
- 4 = COM ground/common.
- 5 = FTC NC (normally closed) photocell contact

LASER 100B

Wiring:

- 1 = - negative power supply 12/24V ac/dc
- 2 = + positive power supply 12/24V ac/dc
- 3 = COM ground/common
- 4 = OUT= depending on Jumper position it becomes NO(normally open) or NC (normally closed) output contact

LASER 200

Wiring:

- 1 = - negative power supply 12/24V ac/dc
- 2 = + positive power supply 12/24V ac/dc
- 3 = FTC NC (normally closed) photocell contact
- 4 = COM ground/common.
- 5 = START NO (normally open) contact

■ SOLAR PANELS SOLAR 1012 / SOLAR 2012/ SOLAR 3012 / SOLAR2524

It is recommended to position the solar panel at a distance not exceeding 10 meters from the automation control board. Use a outdoor use 2 wired cable 0,5mmq. if the panel has to be placed at a higher distance from the control board, use a 2 wires 1mmq outor use cable. Fix the solar module to the wall with the supplied fixing bracket.

The solar module should be facing south. And at full light. Check that no obstruction or shadow reduces lighting to the solar panel. Connect the module to the electronic board and pay attention to the polarity of the wiring. Connect the panel to the circuit board being careful to respect the polarity of the wiring.

 Warning: in case of intensive use or to ensure greater autonomy in low light conditions it may be advised to use sgreater solar panelcombined with a greater storage capacity battery. combining a minimum 12V 12A battery. Warning: when increasing the watt of the solar module, the battery capacity must be increased proportionally. In the case of double solar panels or dual batteries, note that one terminal in series connection will increase the volts(V) and a parallel connection will increase the ampere (A)

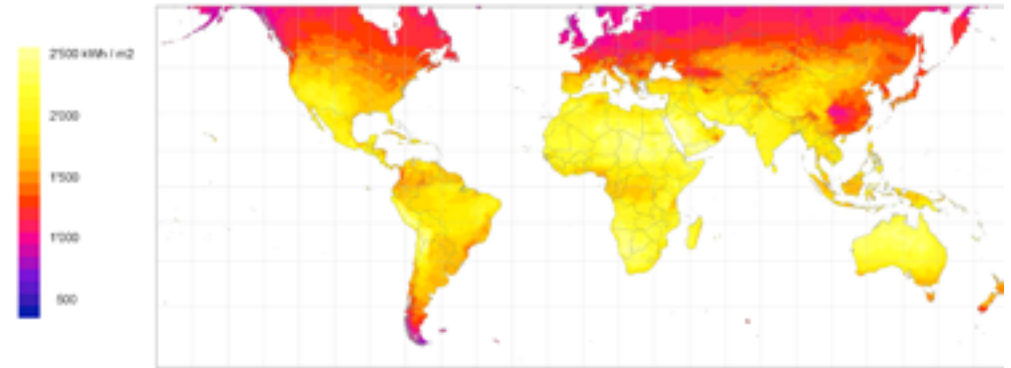

SUNLIGHT WORLD MAP to control the level of solar radiation at your location - use the free APP of the European program PVGIS at the following link: <http://re.jrc.ec.europa.eu/pvgis/apps4/pvest.php?lang=it&map=europe>

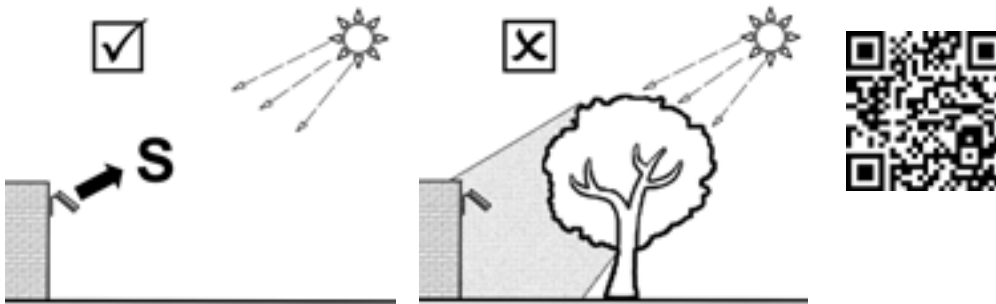

Board model	GATE	Stand-by consumption (A)	daily consumption	Consumption for a complete cycle (open+ close), (A)	Suumption of total n° of daily cycles (open+close)	total daily consumption (A)	average charge of a 10W 12V solar panel (A /hour) in non ideal weather	hypotesis of lixght exposure (hours/per day)	Total recharge capacity (A)	balance between consumption and recharge
CTH44	1 wing	0,007	0,16	0,012	60	0,88	0,3*	5	1,5	+ 0,62
CTH48	2 wings			0,024	50	1,36				+ 0,14

The table gives an estimation of autonomy in the worst light conditions (we calculated only 5 hours of daily light with a low brightness level).

This condition may correspond to the situation: winter with overcast / partly covered or veiled.

The table shows the maximum number of maneuvers, maintaining the same level of charge of the battery.

With summer weather and excellent exposure to light for more hours per day, the levels of autonomy increase exponentially.

With use of photocells and especially in the case of double pair of photocells SW7120 we recommend the use of a 20W panels combined with a 12A battery to ensure an even better energy autonomy.

NOTE: the solar panel 1020 combined 12V 12A battery has a charging capacity of about 1A / hour ,exponentially increasing the autonomy compared to a 10W panel 7A battery.

Caution: the use of a solar panel 20W combined to a 12V 7A battery is inadvisable because it would not exploit all the charge given by the panel.



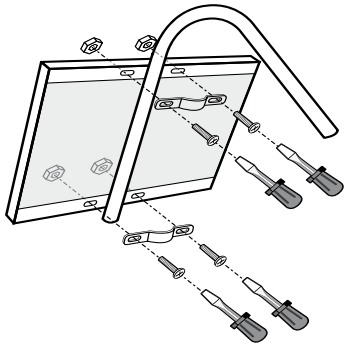
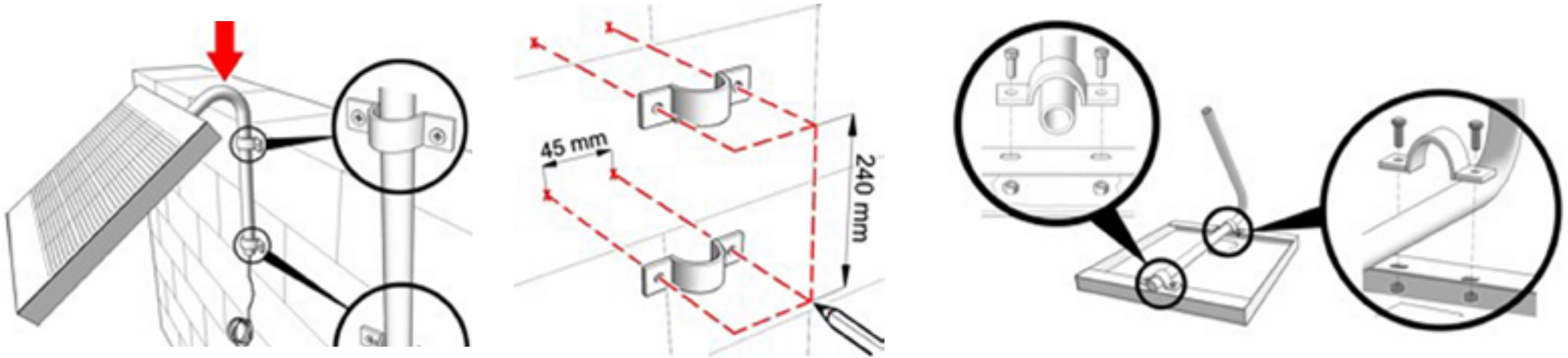



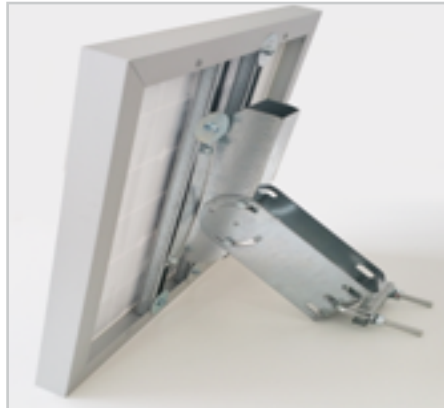



- Example Mounting Bracket 10W solar module Solar1012 (Attention: brackets may be different to the pictures below)









- Example of Mounting Bracket for Larger Modules (Attention: Brackets may be different to the pictures below)











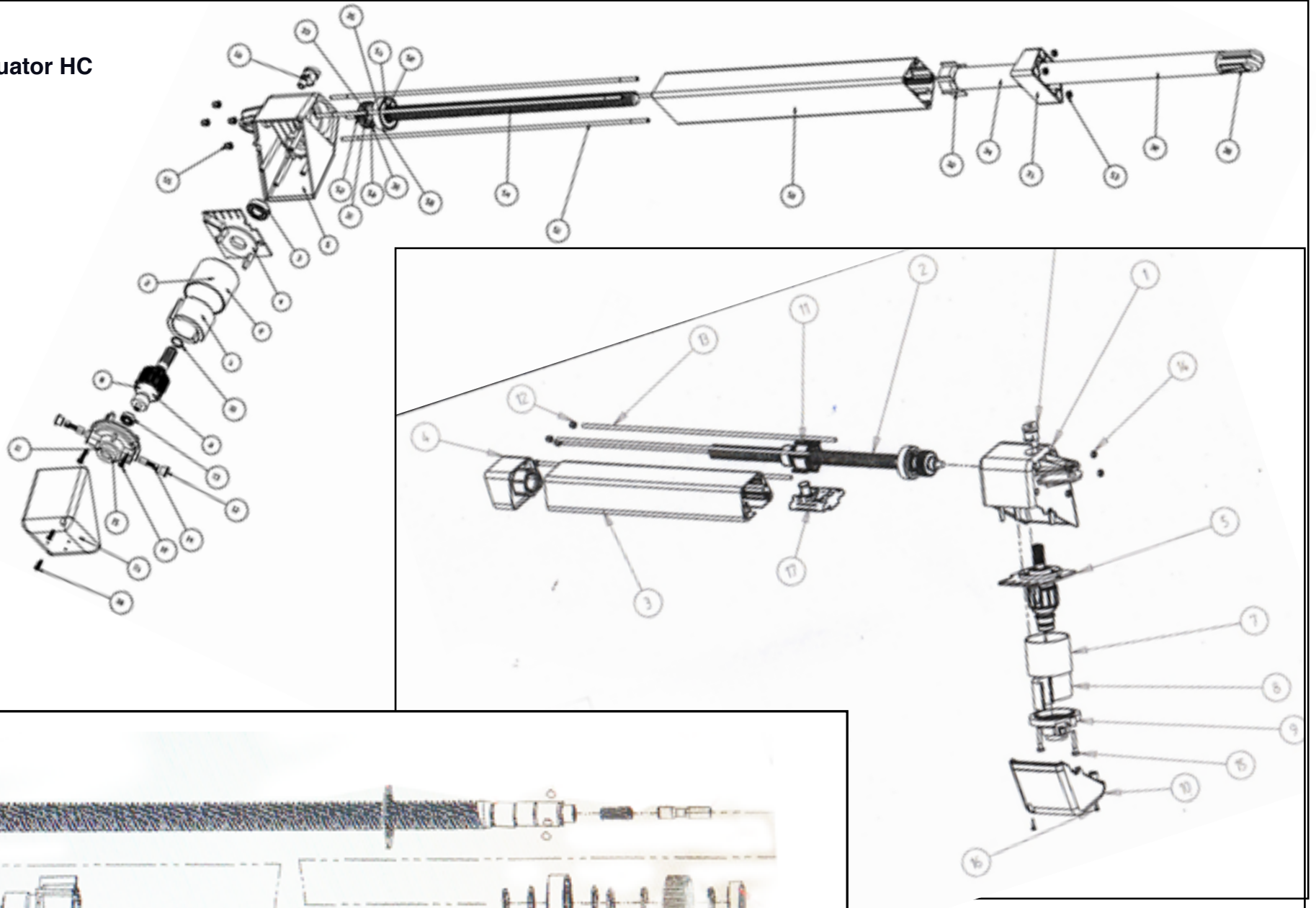



Accessories: remote controls, radio receivers GSM openers, and other wired controls devices		
Model	Picture	Description
PULT 6202		NEW ! Ducati radio rolling coded , 2 channels remote control 433,97 MHz working range up to 30m. 4 colors available:
PULT 6208		NEW ! Ducati radio rolling coded , 4 channels remote control 433,97 MHz working range up to 30m
PULT 6203 R		Ducati radio rolling coded , 2 channels remote control 433,97 MHz working range up to 50m
PULT 6203 P		Ducati radio rolling coded , 2 channels remote control 433,97 MHz extra working range up to 100m
PULT 6204		Ducati radio rolling coded , 4 channels remote control 433,97 MHz working range up to 30m
RIXY 6040		4 channels Radio receiver. Ducati radio rolling coded. 433,97 MHz. storage capacity: max.100 codes (25 each channel) stable/
RIXY 6043		3 channels Radio receiver with display. Ducati radio rolling coded. 433,97 MHz. storage capacity: max.100 codes.1 channel with temporization 0-6 minutes. stable/bistable
STILO 6023		Universal Antenna 433,92MHz. fixing bracket & 5m cable included. +0,5Db
STILO 6025		Universal Antenna 433,92MHz. 5m cable included. +0,5Db to be directly fixed on FLASH blinkers
TASTY 6700		1 channel radio keypad .Ducati radio rolling coded , 433,97 MHz for outdoor use stainless stell case
TASTY 6704		4 channels radio keypad .Ducati radio rolling coded , 433,97 MHz for outdoor use stainless stell case
SW 6500		1 channel radio keypad .Ducati radio rolling coded , 433,97 MHz for outdoor use
SW 6504		4 channels radio keypad .Ducati radio rolling coded , 433,97 MHz for outdoor use
KEY 5502		key switch with 1 NO (normally open) contact switch. 1 pair of keys
KEY 5005		key switch with 1 NO (normally open) contact switch. 1 pair of keys
KEY 5005 INOX		key switch with 1 NO (normally open) contact switch. 1 pair of keys stainless steel cover
GSM MODUL		GSM MODULE to command the gate opening by a free phone call.
GSM INTERCOM		NEW ! GSM intercom. Respond to from your mobile phone to all calls from the doorbell. With GSM opening. opens the gate with a free phone call. Up to 200 users

Accessories: Flashing lights, antenna , solar modules & batteries		
Model	Picture	Description
FLASH 7700		Blinking light: 2 versions available: 12V / 24V
FLASH 7500		Blinking light: 2 versions available: 12V / 24V
HC 7500/12		Blinking light: 2 versions available: 12V / 24V
FLASH / LED		LED lighting circuit 12V-24V ac/dc to be used on FLASH blinkers
_KB 9000		Blinking light with Xenon Lamp
STILO 6023		Universal Antenna 433,92MHz. cable included. +0,5Db to be directly fixed on FLASH blinkers
STILO 6025		Universal Antenna 433,92MHz. cable included. +0,5Db with wall mounting bracket
SOLAR 1012		12V 10W Photovoltaic solar panel with bracking bracket. Polarized output +/-
SOLAR 2012		12V 20W Photovoltaic solar panel with bracking bracket. Polarized output +/-
SOLAR 3012		12V 30W Photovoltaic solar panel with bracking bracket. Polarized output +/-
BAT1212		Rechargeable 12V 12A Battery. Dimension 15 cm x 10 cm x 9cm h
BAT 0712		Rechargeable 12V 7A Battery. Dimension 15 cm x 6,5 cm x 9cm h
BAT 0512 SLIM		Rechargeable 12V 7A Battery. Dimension 15 cm x 5 cm x 9cm h
BAT 0212		Rechargeable 12V 2,2A Battery. Dimension 15 cm x 6,5 cm x 9cm h
C/M/BAT		Module for battery chqrge management and panel supply main power sypply management compatible with CTH42 and CTH43 electronic board
MPBAT		12V 0,5A battery charger with cable and UE plug class A. polarized +/- terminals 6,3

Accessories: Safety devices		
Model	Picture	Description
LASER 7120		Pair of low consumption photocells with stainless steel case. compatible with scontrol board CTH44 & CTH48. 12/24V a.c./d.c./NC
LASER 7012		Pair of univerala photocells. 12/24V a.c./d.c./NC
LASER 100		Pair of universal photocells. 12/24V a.c./d.c./NC +NO contact
SW 7120		Pair of low consumption photocells. compatible with scontrol board CTH44 & CTH48. 12/24V a.c./d.c./NC
SW 7012		Pair of univerala photocells. 12/24V a.c./d.c./NC
KOL 450		Pair of coloumns with intefrated photocells model LASER100 42cm h
KOL 750		Pair of coloumns with intefrated photocells model LASER100 75cm h
KOL 120		Pair of coloumns with intefrated photocells model LASER100 1 coloumn 75cm h + 1 coloumn 120cm h with integrated key switch
E-LOCK 1012		Elektrik lock 12V/24V ac
Booster 1012		“Booster” for electric lock E-LOCK1012 (to trnsform dc current output into ac current

Telescopic actuator HC



Spare Parts for HC actuators		
Model	Picture	Description
R70		pair of carbon brushes
R15		universal trilobed key for manual release
R14		unlocking pin
GIU0114		gear module 1,25 Z27
0138		1m Motor cable I H05RNFF with faston connectors for carbon-brush holder
R39		Rotor for actuators (check all versions available online)
R76		Motorgear (check all versions available online)
R4		Motorgear housing PA6
R40		Carbon brushes holder (carbon brushes are not included)
R9		Black Aluminium profile for actuator HC312. length = 33,5cm
R9/418		Black Aluminium profile for actuator HC418 and HC418. Länge = 43,5cm
R9/518		Black Aluminium profile for actuator HC512 and HC518. Länge = 53,5 cm
R9/618		Black Aluminium profile for actuator HC612 and HC618. Länge = 63,5cm
R1		Stainless steel pipe tube with mainscrew made of Hostaform® and front fixing for actuator HC312. Tot. Length 51,5cm
R1/400		Stainless steel pipe tube with mainscrew made of Hostaform® and front fixing for actuator HC412. Tot. Length 61,5cm
R1/500		Stainless steel pipe tube with mainscrew made of Hostaform® and front fixing for actuator HC512. Tot. Length 71,5cm
R1/600		Stainless steel pipe tube with mainscrew made of Hostaform® and front fixing for actuator HC612. Tot. Length 81,5cm













Spare parts for actuators HC line		
Model	Picture	Description
R2		PR80 steel 3 principles spindle. Diameter 20mm. for actuator HC312. Tot.lenght 395 mm
R2/400		PR80 steel 3 principles spindle. Diameter 20mm. for actuator HC412 & HC418. Tot.lenght 495 mm
R2/500		PR80 steel 3 principles spindle. Diameter 20mm. for actuator HC512 & HC518. Tot.lenght 595 mm
R2/600		PR80 steel 3 principles spindle. Diameter 20mm. for actuator HC612 & HC618. T Tot.lenght 695 mm
SW010		main nut screw 3 principles made of Hostaform® for actuator HC418, HC518, HC618
R37		Front cover for non telescopic actuators: HC312, HC412, HC512, HC612
R37CL		Front cover for non telescopic actuators: HC418, HC518, HC618
R11		pins and circlips for actuator HC series (2 pcs)
R8		fixing bracket st for actuators model : HC312,HC412,HC512,HC612
R8-818		fixing bracket st for actuators model HC418, HC518, HC618
R8-EVO		multi-position fixing brackets



Spare parts for actuators SW/ EVO line

Model	Picture	Description
SW101		ABS germotor cover for actuators SW and EVO line
SW100		PA6 gearmotor housing for actuators SW and EVO line
GIU110		Carbon brushes holder (carbon brushes not included) or actuators SW and EVO lines
R70		pair of carbon brushes
R39SW		Rotor for actuators SW and EVO lines (check all versions availables online)
R76SW		Motorgear for actuators SW and EVO lines (check all versions availables online)
SW125		Black Alluminium profile for actuators SW400 und SW400T. lenght = 42,5cm . (check online availables colors)
EVO 125		Black Alluminium profile for actuators EVO700 und EVO700T lenght = 72,5cm . (check online availables colors)
SW114		Front cover for non telescopic actuators SW and EVO line
SW124		Front cover for telescopic actuators SW and EVO line
SW010		main nut screw 3 principles made of Hostaform® for non telescopic actuators SW and EVO line (SW400 and EVO700)
R2/400 SW		PR80 steel 3 principles spindle. Diameter 20mm. for actuator SW400 und SW400T. Tot.lenght 495 mm
R2/600 EVO		PR80 steel 3 principles spindle. Diameter 20mm. for actuator EVO700 und EVO700T. Tot.lenght 695 mm
R1/400		Stainless steel pipe tube with mainscrew made of Hostaform® and front fixing for actuator SW400T. Tot.lenght 61,5cm
R1/600		Stainless steel pipe tube with mainscrew made of Hostaform® and front fixing for actuator EVO700T. Tot.lenght 81,5cm

DUCATI Spare parts for actuators SW-EVO line









Spare parts for actuators SW/ EVO line		
Model	Picture	Description
R70		pair of carbon brushes
R15		universal trilobed key for manual release
R14		unlocking pin
GIU0114		gear module 1,25 Z27
0138		1m Motor cable I H05RNFF with faston connectors for carbon-brush holder
SW105		pins and circlips for actuator SW und EVO series (2 pcs)
R8		fixing bracket st for actuators model : SW400T
R8-818		fixing bracket st for actuators model SW400
R8-EVO		multi-position fixing brackets for EVO actuators

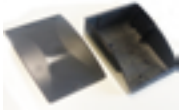

Spare parts for actuators EVE line		
Model	Picture	Description
EVE753		Die cast alluminium cover for actuator model EVE900T & EVE 900
SW100		PA6 gearmotor housing for actuators EVE line
GIU110		Carbon brushes holder (carbon brushes not included) for actuators EVE lines
R39SW		Rotor for actuator EVE (check all versions available online)
R76SW		Motorgear for actuator EVE line (check all versions available online)
R70		pair of carbon brushes
R15		universal trilobric key for manual release
R14		unlocking pin
GIU0114		gear module 1,25 Z27
0138		1m Motor cable I H05RNFF with faston connectors for carbon-brush holder
R2/500 EVET		PR80 steel 3 principles spindle. Diameter 20mm. for actuator EVE900T. Tot. Length 595 mm
R1/500 EVET		Stainless steel pipe tube with mainscrew made of Hostaform® and front fixing for actuator EVE900T. Tot. Length 63 cm
R8-EVO		multi-position fixing brackets for EVE actuators



DUCATI Spare parts for Control Boxes

Spare parts for Control boxes		
Model	Picture	Description
PLBOX		Inner protection cover for electronic board models: CTH42; CTH44; CTH48,CTH48/24V
PLBOX 812		ABS control box housing for electronic board models: CTH42; CTH44; CTH48,CTH48/24V
PLBOX 818		ABS control box housing for electronic board models: CTH1,CTH41 Mono
RU403UE		Toroidal transformer 230V 105W Output 0-12-24V
RU403USA		Toroidal transformer 110V 105W Output 0-12-24V
CTH41		12V electronic board for 2 wings gate openers- <i>entry level</i>
CTH41 MONO		12V electronic board for 1 wing gate openers- <i>entry level</i>
CTH42		12V electronic board for 1 or 2 wing gate openers <i>standard level</i>
CTH44		12V electronic board for 1 or 2 wing gate openers <i>special solar panel power supply</i>
CTH48		12V electronic board for 1 or 2 wing gate openers <i>top level ac-battery or solar panel power supply compatible</i>
CTH48/24V		12V electronic board for 1 or 2 wing gate openers <i>top level ac-battery power supply compatible</i>
CMBAT		Module for battery charge management and panel supply main power supply management compatible with CTH42 and CTH43 electronic board



Safety is of primary importance, DUCATI is proud to ensure that his products and accessories comply with the latest European laws

The manufacturer guarantees, as tested and certified by NEMKO and INTERTEK notify bodies that the products actuators, used with the original control units relative, when properly installed according to this manual are in compliance with the European standard EN 12445; EN 12453; EN 12635 and EN 13241-1

Note that the final machine is composed by the gate operator with the gate itself (structure). The installer by using a specific dynamometer, has to test and certify to the final user that the machine composed by the gate and the gate opener in their entirety, comply to the EU norms as required by the specific legislation.

Any new or existing installation requires a declaration of conformity issued by the final installer. The installer must test the final machine and attest the compliance to the latest European standards concerning impact forces in case of obstacle detection. Tests must be performed with a dynamometer in precisely specified positions

DUCATI devices are ready to achieve total safety even when installing in a variety of contexts. Thanks to these standards many businesses in automation industry choose DUCATI technology to ensure their installations meet the standards of safety their customers demand.



We declare that the products listed in this manual fully comply with following EU norms:

EMV - Elektromagnetische Verträglichkeit
 EN55014-1-2006+A1:2009
 EN55014-2-1997+A1+A2:2008
 EN61000-3-2:2006+A1+A2:2009
 EN61000-3-3:2008

LVD - Niederspannungsrichtlinie
 EN60335 1-2001+A13 2008 + A14 2010
 EN60335-2-103:2003 +A11 2009
 EN62233-2008

Sicherheitsvorschriften Aufprall
 EN 13241-1:2003 +A1
 EN12453:2000
 EN12455:2000

R&TTE - RADIO & TELEKOMMUNIKATION
 EN301489-3V.1.4.1
 EN 300 220-2V.2.1.2

FCC-USA TELEKOMMUNIKATION KOMMISSION
 FCC ID: OLS137925764 Washington laboratories tested * remote mod.6203

RoHS - RESTRICTION OF HAZARDOUS SUBSTANCES

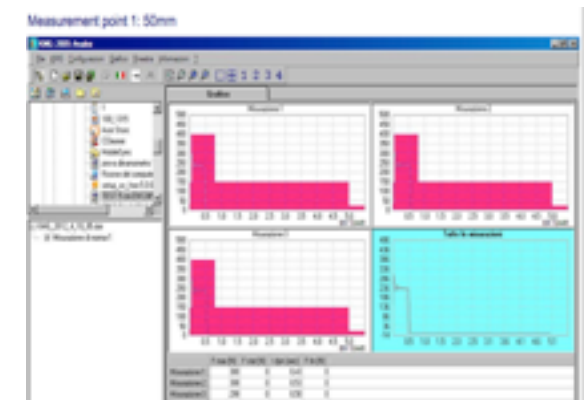



Limited Manufacturer's Warranty

1- The warranty shall be liable only for defects which are due to manufacturing or material defects.

2- The warranty is valid for two years from date of purchase.

3- Manufacturing error should occur within this limited warranty period, the customer must report this immediately and before disassembling the product to the customer service of the dealer. The product should be returned to the manufacturer where it is tested. Before sending the product, the warranty request must be submitted to the manufacturer.

Transportation costs are charged to the customer. The customer should enclose a brief description of the problem and the cash receipt as proof of warranty period.

4- The manufacturer's obligation is limited to the repair or replacement of the product. A refund of the purchase price is not possible without specific agreement with manufacturer.

Defective parts will be repaired or replaced with new parts from the manufacturer

5- This limited warranty does not cover: Transport costs, maintenance costs of the product or installation, inspection or control of parts of the product for any reason whatsoever, within and outside the warranty period, shall be borne by the customer and never at the expense of the manufacturer.

6- This warranty does not apply interventions or modifications by unauthorized third parties or the end user, as well as improper or inadequate installation, it must be taken according to the installation instructions and use only as directed and use as described by the manufacturer.

Intentional or accidental damage, as described above, are not entitled to warranty.

7- There is no liability for :

a) installation, periodic inspection, maintenance, the costs for the installation of the repaired or replaced parts.

b) The warranty does not cover wearing parts, such as Fuses, batteries, brushes, bulbs, etc.

c) transportation costs, maintenance or installation, with respect to this product, for any reason whatsoever, including shipping back to the company, in or out of warranty are to be borne by the customer or selling dealer and never at the expense of the manufacturer.

d) misuse, improper installation, damage or malfunctions that are not due to product defects, damages that are due to external environmental influences of any kind, improper maintenance or repair, improper alteration to the product, with structural problems of pillars, gates, doors, etc.

e) Damage caused by fire, humidity, water, natural phenomena, thunderstorms, lightning

Radio interference or interference from other electrical devices; shorts due to a wrong power connection or power fluctuations on the network as well as all other cases beyond the control of the manufacturer.

8- The warranty is subject to compliance with the technical characteristics and correct, proper installation according to instructions.

Safety standards and proper application of Instruction manual are of fundamental importance.

The guarantee expires soon be demonstrated in the review of the product, manipulation or abuse.

AFTER SALES SERVICE

For all requests for assistance, in or out of warranty, use the following procedure:

Write us an e-mail to info@ducatihome.it or phone us to describe your problem,

TAILORED CUSTOMER SERVICE & ASSISTANCE 7/24

We favor the human relationship and direct contact with the customer to meet every need.

we are a CUSTOMER-FRIENDLY company. Don't hesitate to contact us we speak English, français, Italiano, Deutsch

for any inquiry write to: info@ducatihome.it phone call: +39-335-1022019 / +39/0524-527967

Contact us right away ! We'll solve any issues. Our technicians will immediately help to identify the cause of the problem.



After installation is performed it is mandatory to test the product and the safety of the full system. The following operations are the most important to ensure the maximum safety of the system.

Any intervention must be carried out by qualified and experienced technician who must carry out the necessary tests in order to exclude any risks. The inspection must be carried out in compliance with the applicable regulations, laws, rules and regulations, in particular these requirements of the standards EN 13241-1, EN 12445 and EN 12453 must be met.

Additional equipment must undergo certain tests.

The test can also be performed periodically to verify the components of automation. Each individual component requires specific testing. Perform the test as follows:

1. Check that the structure is safe and correctly installed. Check that all points of the preliminary safety instructions of this manual are fulfilled.
2. Check the correctness of all electrical connections and the good condition of the fuses and batteries.
3. Check the correct operation of the emergency manual release. Unlock the gear motor (s) and check that it is possible to manually open and close the gate, with the applied force not exceeding the value of the operating limits. Block the geared motor.
4. Use the key switch or the command buttons or the remote control to check whether the door opens and closes and the movement is correct.
5. Verify the proper functioning of each safety device on the system.
 - 5.1 Check that the photocells always work from the active state to the alarm switching state and vice versa
 - 5.2 Check that the intervention in the central unit triggers the intended action: for example, that the reversal takes place during the closing maneuver.

If the dangerous situations caused by the movement of the gate have been secured by limiting the impact force, the measurement of the force shall be in accordance with the standard EN 12445 EN 12453 with dynamometric measurement. If the Force setting is used as an aid to reduce the impact force, try until the best result is obtained.

The commissioning can only take place after all the above test phases have been successfully completed.

Partial commissioning or only in temporary situations is not allowed.

Preserve the technical documentation and keep it (at least 10 years), which must include: general drawings of the automation, wiring diagram, analysis of hazards and their solutions, manufacturer's declaration of conformity of all equipment, declaration of CE conformity and copy of operation and maintenance plan the automation.

Attach a permanent label or label to the door describing the manual unlocking operations of the drive. Attach a permanent label or sign to the gate indicating a danger: "Automated Gate" to warn a third party (goal movement). The owner must be given the declaration of conformity of the automation, the operating instructions and the maintenance plan.

For safety reasons, it is very important to regulate the "strength". This process must be performed with the utmost care by trained personnel. Important!

- Adjust the strength so that the maneuver can be carried out correctly. Setting larger values than required may result in injury to persons and animals in the event of an impact, or cause property damage

DUCATI Trouble solving: Most commons problems and solutions

PROBLEMS RELATED TO THE RADIO RECEPTION

SYMPTOM	POSSIBLE CAUSE	SOLUTION
one of the radio remote controls is not working, while the other remote controls work properly	battery of the remote control is out of power/ has not enough power	replace the battery of the radio remote controls
	elctronic board storage capacity is full	erase the memory on your electronic board and re-store the remote control button you want to use, taking care not to exceed the limit of storable codes. if you must use a greater number of remotes, add an external radio receiver model 6040rol or 6043 with dispaly
	defective or broken remote control	if under warranty send the remote control support for check and replacement. if out of warranty purchase a new remote control
any of the radio remote controls works	the radio controls were not stored in the automation control board	precautionary reset the memory of the electronic board of your opener, and then store one by one the radio control channels that you want to use.
	the radio control model used is not compatible with the electronic board	Be sure to use the original DUCATI remote controls and be sure to use a model of remote control compatible with your electronic board. The generation "CTR" boards use radio remote controls with fixed code 12-bit , while the "CTH" generation boards use radio rolling coded remote control.
	on board radio hybrid receiver damage	Contact the DUCATI official assistance centre. send the board to he assistance for repair in or out of warranty. If out of warranty radio receiver problem you can n also opt to buy an external radio receiver 6040rol or 6043 in order to avoid sending the damaged board to the service center. To check that the problem is on the hybrid radio receiver. Try to operate your gate opener commanded by wired control (use a keypad or bridge the "START terminals") to check the correct peration not radio control)
the radio remote controls only work at close range	battery of the remote control is out of power/has not enough power	replace the battery of the radio remote controls
	radio interference	identify the cause of the interference / noise / barrier to radio reception and eliminate it
	on board radio hybrid receiver damage	Contact the DUCATI official assistance centre. send the board to he assistance for repair in or out of warranty. If out of warranty radio receiver problem you can n also opt to buy an external radio receiver 6040rol or 6043 in order to avoid sending the damaged board to the service center
The gate opens by itself	radio interference from other devices	Problems verifiable with radio 12-bit encoding openers only, which are subject to interference from other radio devices. it is suggested to change the system with a radio rolling code version that with over 3 billion continuously changing code guarantee absolute protection.

SYMPTOM	POSSIBLE CAUSE	SOLUTION
the gate opens but does not close and photocells are not installed	photocells bridge do not make contact or has been removed	re-place the photocell's bridge that keeps closed the photocell contact on your electronic board. and check the contact face properly.
the gate opens but does not close and photocells are installed	error in connecting/wiring the photocells	Check that you are using compatible photocells to your electronic board model (note low consumption photocell model 7120 are only compatible with electronic board CTH44 & CTH48. Check the photocells wiring: it could be incorrect . Check the wires are not interrupted.
	photocells are not aligned	Check that the fococells are correctly aligned
	photocells are dirty inside or outside	Open the photocells and check that there is no dirt or insects inside them. Clean the photocells, but mantain them aligned.
both doors open, but only one closes;	relay stucked	contact Ducati's after sale service for under warranty or out of warranty repair
una sola anta apre completamente ma la seconda non effettua alcun movimento	relay stucked	contact Ducati's after sale service for under warranty or out of warranty repair
one door completely open but the second does not perform any movement	you commanded the pedestrian opening cycle (only one wing M1 opens partially)	use another remote control button to control the full cycle opening
the gate opens but stops the movement before the mechanical stop	Wrong motor power/ obstacle sensitivness Adjustment	increase the power by turning the potentiometer clockwise to increase the power and reduce the obstacle detection sensitiveness
the leaf is moving too fast and slams on the setback	Not ideal actuator's pfixing position on the pillar (measures A & B) are not the ideal ones)	change the position of the fixing brackets by choosing a location which results in an increased use of the piston stroke. With CTH48 card template regulate the beginning of the slowdown to a smooth stop of the movement on the mechanical stop. For large gate wings you couls evaluate to add an electrolock.
Qualsiasi altro problema o malfunzionamento	To be analyzed with Ducati technicians first	send an e-mail to info@ducatihome and describing your problem. It is important to indicate your gate opener model or at least your motor + electronic board model and date of purchase.

ducatihome.it



Ducati Home Automation

Automazione Cancelli

via Cassani 43036 Fidenza (PR) ITALY

t +39-0524-527967 f +39-0524-591085

mob +39-335-1022019

mob +39-392-9423518

info@ducatihome.it



Watch our video manuals :

[Ducati Home Automation: https://www.youtube.com/channel/UCJKLq3d4cQQ9ENh7wxY2iFw](https://www.youtube.com/channel/UCJKLq3d4cQQ9ENh7wxY2iFw)

You **Tube**

