



Ditec TOP603H / TOP903H

IP2179EN
Technical Manual

Automation for sectional
doors (translation of the original instructions)

Contents

Subject		Page
1.	General safety precautions	54
	General safety precautions for the user	55
	Machinery Directive	56
2.	Declaration of Incorporation	57
3.	Technical specifications	58
3.1	Operating instructions	58
3.2	Possible applications with general sectional doors	59
3.3	Possible applications with ENTREMATIC sectional doors	60
4.	Dimensions	61
5.	Standard installation	62
6.	Main components	63
7.	Assembly guide	64
8.	Tensioning the belt	65
9.	Assembling the automation	66
10.	Mechanical installation	67
11.	Assembling and fastening the arm	68
12.	Installing the adapter for TOPSB tilting doors	70
13.	Electrical connections TOP603H	71
13.1	Wiring the accessories	72
13.2	Commands TOP603H	74
13.3	Outputs and accessories	74
14.	Commands and indications	75
14.1	Deleting the memorised stroke values	75
14.2	Restoring the factory settings	75
15.	Self-learning of the stroke TOP603H	76
16.	Memorising / Deleting remote controls	77
17.	Adjusting the parameters	77
18.	Parameters	78
19.	Electrical connections TOP903H	81
19.1	Wiring the accessories	82
19.2	Commands TOP903H	84
19.3	Outputs and accessories	84
20.	Commands and indications	85
20.1	Deleting the memorised stroke values	85
20.2	Restoring the factory settings	85

21.	Self-learning of the stroke TOP903H	TOP903H	86
22.	Memorising / Deleting remote controls		87
23.	Adjusting the parameters		88
24.	Parameters		89
25.	Troubleshooting	TOP603H TOP903H	93
25.1	Alarms		94
26.	Maintenance		95
	Replacing the fuse		95
	Replacing the courtesy light		95
	Replacing the remote control battery	96	

Key



This symbol indicates instructions or notes regarding safety, to which special attention must be paid.



This symbol indicates useful information for the correct functioning of the product.

1. General safety precautions



Failure to respect the information given in this manual
may cause personal injury or damage to the device.
Keep these instructions for future reference

This installation manual is intended for qualified personnel only.

Installation, electrical connections and adjustments must be performed by qualified personnel, in accordance with Good Working Methods and in compliance with the current regulations. Read the instructions carefully before installing the product.

Incorrect installation could be dangerous.



The packaging materials (plastic, polystyrene, etc.) should not be discarded in the environment or left within reach of children, as they are a potential source of danger.

Before installing the product, make sure it is in perfect condition.

Do not install the product in explosive areas and atmospheres: the presence of inflammable gas or fumes represents a serious safety hazard.

Before installing the motorisation device, make all the necessary structural modifications to create safety clearance and to guard or isolate all the crushing, shearing, trapping and general hazardous areas.

Make sure the existing structure is up to standard in terms of strength and stability. The motorisation device manufacturer is not responsible for failure to observe Good Working Methods when building the frames to be motorised, or for any deformations during use.

The safety devices (photocells, safety edges, emergency stops, etc.) must be installed taking into account the applicable laws and directives, Good Working Methods, installation premises, system operating logic and the forces developed by the motorised door or gate.

The safety devices must protect against crushing, cutting, trapping and general danger areas of the motorised door or gate.

Display the signs required by law to identify hazardous areas.



Each installation must bear a visible indication of the data identifying the motorised door or gate.

When necessary, connect the motorised door or gate to an effective earthing system that complies with the current safety standards.

During installation, maintenance and repair operations, cut off the power supply before opening the cover to access the electrical parts.

The automation protection casing must be removed by qualified personnel only.



The electronic parts must be handled using earthed antistatic conductive arms. The manufacturer of the motorisation declines all responsibility if component parts not compatible with safe and correct operation are fitted.

Only use original spare parts when repairing or replacing products.

The installer must supply all information concerning the automatic, manual and emergency operation of the motorised door or gate, and must provide the user with the operating instructions.

General safety precautions for the user



These precautions are an integral and essential part of the product and must be supplied to the user.

Read them carefully since they contain important information on safe installation, use and maintenance.

These instructions must be kept and forwarded to all possible future users of the system.

This product must only be used for the specific purpose for which it was designed.

Any other use is to be considered improper and therefore dangerous. The manufacturer cannot be held responsible for any damage caused by improper, incorrect or unreasonable use.

Avoid operating in the proximity of the hinges or moving mechanical parts. Do not enter within the operating range of the motorised door or gate while it is moving.

Do not obstruct the motion of the motorised door or gate, as this may cause a dangerous situation.

The motorised door or gate may be used by children over the age of 8 and by people with reduced physical, sensorial or mental abilities, or lack of experience or knowledge, as long as they are properly supervised or have been instructed in the safe use of the device and the relative hazards.

Children must be supervised to make sure they do not play with the device, nor play/remain in the sphere of action of the motorised door or gate.

Keep remote controls and/or any other command devices out of the reach of children, to avoid any accidental activation of the motorised door or gate.

The self-adhesive label (supplied) highlighting the risk of children getting trapped must be attached in a clearly visible place.

In the event of a product fault or malfunction, turn off the power supply switch. Do not attempt to repair or intervene directly, and contact only qualified personnel.

Failure to comply with the above may cause a dangerous situation.

Any repairs or technical interventions must be carried out by qualified personnel.

Cleaning and maintenance work must not be carried out by children unless they are supervised.

To ensure that the system works efficiently and correctly, the manufacturer's indications must be complied with and only qualified personnel must perform routine maintenance on the motorised door or gate. In particular, regular checks are recommended in order to verify that the safety devices are operating correctly.

All installation, maintenance and repair work must be documented and made available to the user.

Only lock and release the door wings when the motor is switched off. Do not enter within the operating range of the wing.

 To dispose of electrical and electronic equipment correctly, users must take the product to special "recycling centres" provided by the municipal authorities.

Machinery Directive

Pursuant to the Machinery Directive (2006/42/EC), the installer who motorises a door or gate has the same obligations as the manufacturer of machinery and as such must:

- prepare the technical data sheet which must contain the documents indicated in Annex V of the Machinery Directive;
(The technical data sheet must be kept and placed at the disposal of competent national authorities for at least ten years from the date of manufacture of the motorised door);
- draw up the EC Declaration of Conformity in accordance with Annex II-A of the Machinery Directive and deliver it to the customer;
- affix the EC marking on the motorised door or gate, in accordance with point 1.7.3 of Annex I of the Machinery Directive;
- ensure compliance of the motorised door or gate with safety regulations, by installing the necessary safety devices.

Declaration of Incorporation

We:

Entrematic Group AB
Lodjursgatan 10
SE-261 44 Landskrona
Sweden

declare under our sole responsibility that the type of equipment :

The TOP603H and TOP903H automation with remote control for residential garages complies with the following directives:

2004/108/EC Electro Magnetic Compatibility Directive (EMCD)
2002/95/EC Restriction of the use of Hazardous Substances in electrical and electronic equipment (RoHS)
1999/5/EC Radio and Telecommunications Terminal Equipment Directive (R&TTE)
2006/42/EC Machinery Directive (MD), in particular the following essential health and safety requisites:
1.1.2,1.1.3,1.2.1,1.2.3,1.2.4,1.2.6,1.3.2,1.3.4,1.5.1,1.5.2,1.5.3,1.5.8,1.5.9,1.5.10,1.5.11,1.6.3,1.7.3,1.7.4
Technical documentation for safe integration is provided

Harmonised European standards which have been applied:
EN 13849-1 EN 61000-6-2 EN 61000-6-4 EN 60204-1 EN 60335-1

Other standards or technical specifications, which have been applied:
EN 60335-2-95 EN 60335-2-103 EN 55014

EC type examination or certificate issued by a notified or competent body (for full address, please contact Entrematic Group AB) concerning the equipment:

The manufacturing process ensures the compliance of the equipment with the technical file.
The manufacturing process is regularly checked by third parties.

The equipment must not be used until the installation company has declared that the final installed door system complies with Machinery Directive 2006/42/EC.

Compilation of technical file:





Marco Pietro Zini
Entrematic Group AB
Lodjursgatan 10
SE-261 44 Landskrona
Sweden

E-mail: marco.zini@entrematic.com

Place	Date	Signature	Position
Landskrona	2014-07-31	Marco Pietro Zini	President Entrance Automation



3. Technical specifications

	Ditec TOP603H	Ditec TOP903H
Power	230V~, 50/60 Hz	230V~, 50/60 Hz
Power	140W	170W
Thrust	600 N	1000 N
Opening speed	210mm/s	210mm/s
Closing speed	140mm/s	140mm/s
Maximum door area (*)	9.5 m ²	17.3 m ²
Maximum door weight	116kg	210kg
Service class	3 - FREQUENT	3 - FREQUENT
Intermittence	S2 = 5 min S3 = 25%	S2 = 5 min S3 = 25%
Ambient temperature	 -20°C  +50°C	 -20°C  +50°C
Degree of protection	IP20	IP20
Acoustic pressure emitted at a distance of 2m	<69 dB (A)	<69 dB (A)
Control panel	TP603EL	TP903EL
Control panel fuse	1.6A T (delayed)	2x1.6A T (delayed)
Motor power supply	24V= / 9.5A	24V= / 10.5A
Power supply for accessories	24V= / 0.3A max 2 s 24V= / 0.08A continuous	24V= / 0.3A max 2 s 24V= / 0.08A continuous
Radio frequency	433.92 MHz	433.92 MHz
Maximum remote control range	15-50m	15-50m
Remote control functions / programmable keys	50	50
Courtesy light	E14 max 60W	E14 max 60W

(*) N.B.: the maximum door area has been calculated using a specific door weight of 12 kg/ m² (most common). For values <12 kg/m² the maximum area in m² is larger. For values >12 kg/m² the maximum area in m² is smaller [see graphs in par. 3.2 and 3.3]

	TOP803T3 guide	TOP803T4 guide
Max. carriage stroke	2890 +/- 25mm	3978 +/- 25mm
Maximum height of door	2450mm	3500mm

3.1 Operating instructions

Service class: 3 (minimum 10-5 years of working life with 30-60 cycles per day).

Applications: FREQUENT (for multi-family type entrances or small apartment blocks with frequent vehicle access).

- The performance characteristics refer to the recommended weight (approx. 2/3 of the maximum permitted weight). When used with the maximum permitted weight, a reduction in the above mentioned performance levels can be expected.
- The service class, running times and number of consecutive cycles are merely indicative, having been statistically determined under average operating conditions and therefore not necessarily applicable to specific conditions of use.
- Each automatic entrance has variable elements such as friction, balancing and environmental factors, all of which may substantially alter the performance characteristics or working life of the entrance itself or its components (including the automatic devices). The installer should apply suitable safety conditions for each particular installation.

3.2 Possible applications with general sectional doors

Maximum dimensions of door- TOP603H (Max. door weight = 116 kg)

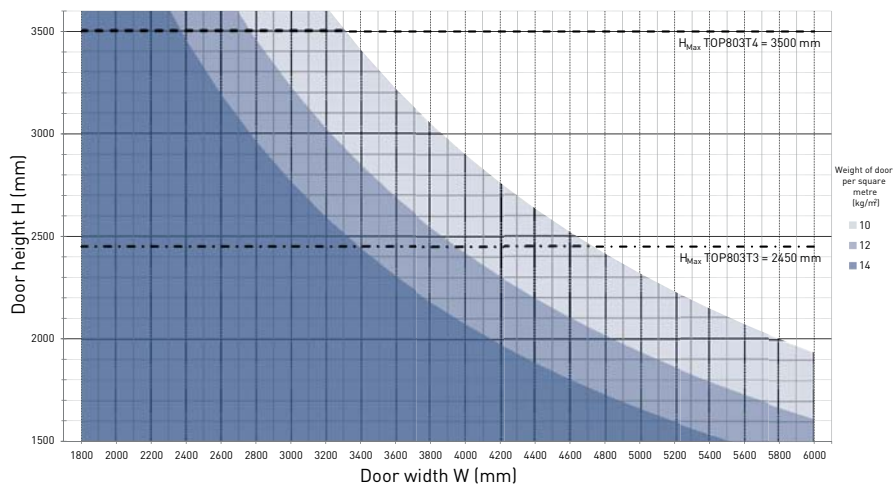

Maximum dimensions of door - TOP903H (Max. door weight = 210 kg)

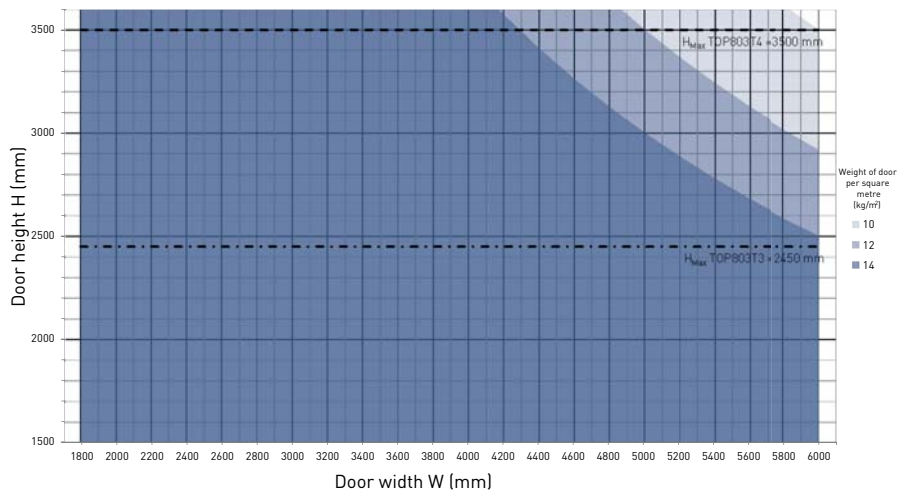

▲ Example 1: sectional door 3.5 metres wide and 2.3 m high, weight 12 kg/m²

TOP603H can be used with the 3 m TOP803T3 guide because it falls within the area enclosed by the 12 kg/m² curve.

● Example 2: sectional door 3.5 metres wide and 2.7 m high, weight 12 kg/m²

TOP603H can be used with the 4 m TOP803T4 guide because it falls within the area enclosed by the 12 kg/m² curve.

■ Example 3: sectional door 3.5 metres wide and 2.6 m high, weight 14 kg/m²

TOP603H CANNOT be used with the 4 m TOP803T4 guide because it does NOT fall within the area enclosed by the 14 kg/m² curve. We recommend using TOP903H.

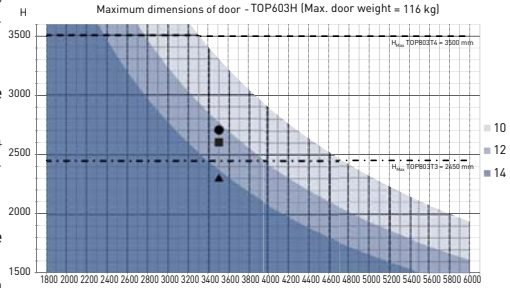

3.3 Possible applications with ENTREMATIC sectional doors

TOP603H

Height	Width									
	1800	2000	2500	3000	3500	4000	4500	5000	5500	6000
3150										
2965										
2815										
2795										
2639										
2483										
2538										
2250										
2125										
2000										
1900										

Dimensions allowed for Style Basic and Style Comfort series doors with Cortex and Tekno design (0.33 mm sheet)

Dimensions allowed for Style Comfort series doors with Plain design (0.6 mm sheet and above)

TOP903H

Height	Width									
	1800	2000	2500	3000	3500	4000	4500	5000	5500	6000
3150										
2965										
2815										
2795										
2639										
2483										
2538										
2250										
2125										
2000										
1900										

Dimensions allowed for Style Comfort series doors with Cortex and Tekno design (0.33 mm sheet)

Dimensions allowed for Style Comfort series doors with Plain design (0.6 mm sheet and above)

4. Dimensions

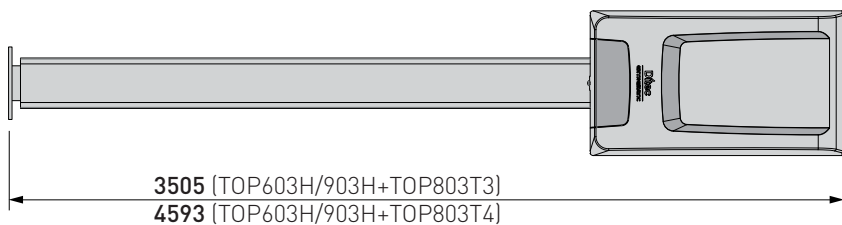
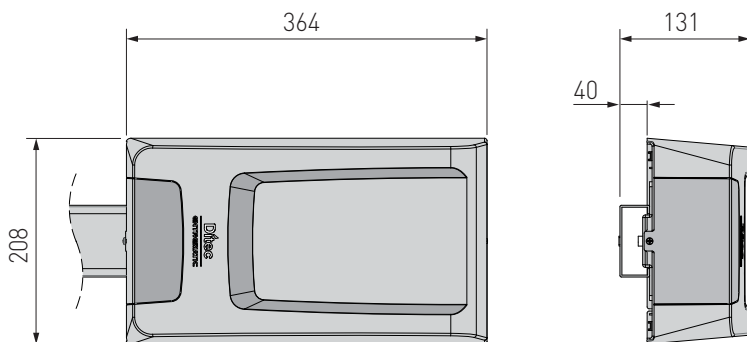

5. Standard installation

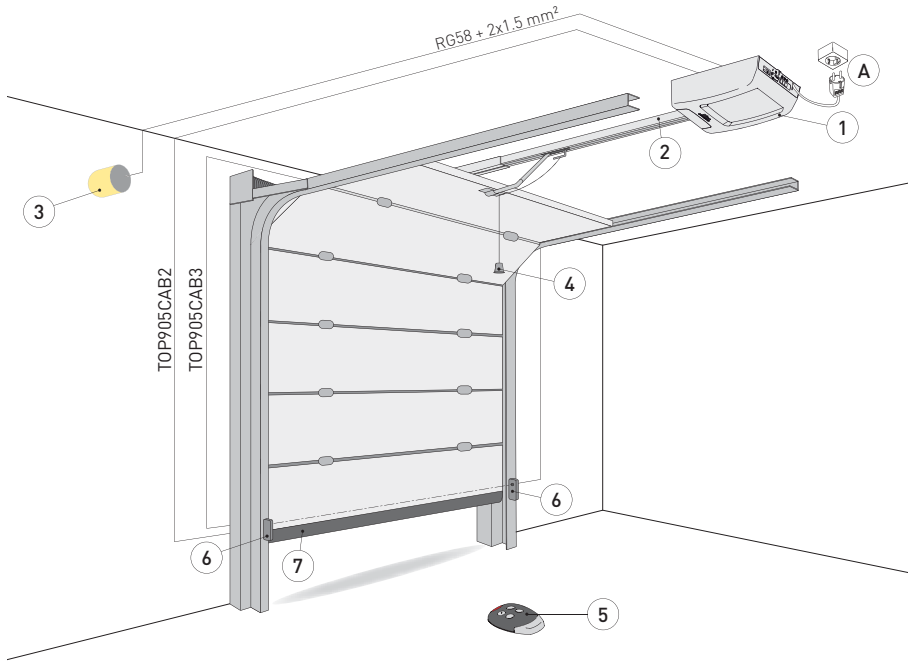

Ref.	Code	Description
1	TOP603H TOP903H	Motor + control panel
2	TOP803T3 TOP803T4	Belt drive system with 3m steel guide Belt drive system with 4m steel guide
3	LAMP	Flashing light 230 V~ (requires the TOP905AC auxiliary card)
4	ASB1 ASB2	Kit for external release with cord and lock Blocking device with cord (2000mm)
5	GOL4	Remote control
6	XEL2 LAB4 LAB4S	Photocells
7		Safety edge
A		Connect the power supply to a suitable earthed socket, about 10-50cm from the pulling unit fixing position.



The declared operating and performance features can only be guaranteed with the use of ENTREMATIC accessories and safety devices.
Unless otherwise specified, all measurements are expressed in mm.

6. Main components

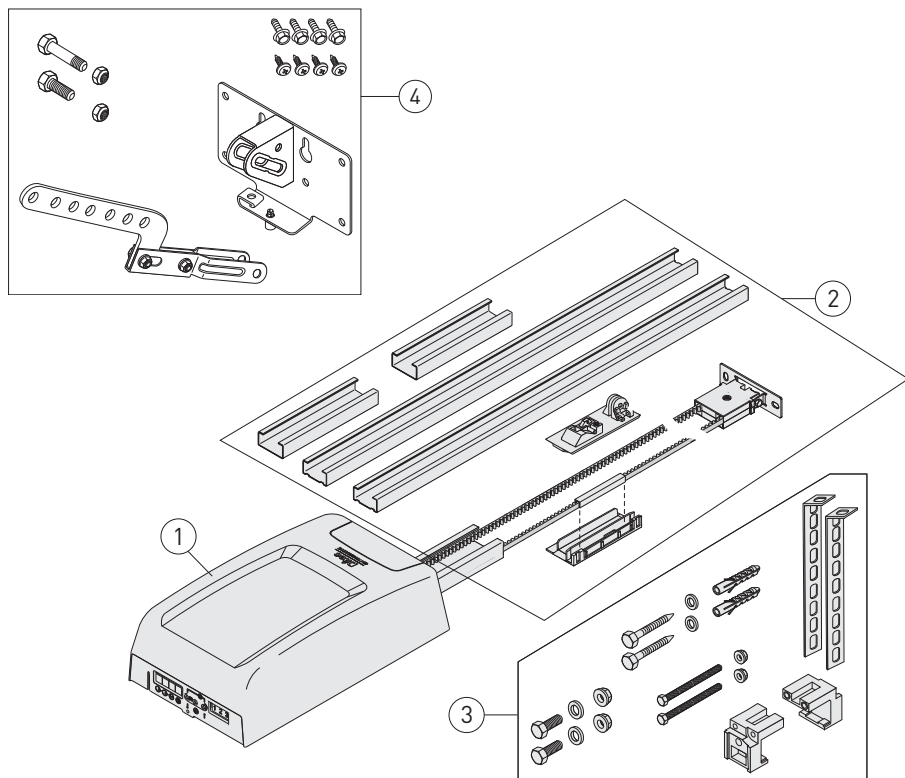

Ref.	Description
1	Pulling unit
2	Drive system
3	Ceiling fixing system
4	Traction arm with retention bracket

7. Assembly guide

1

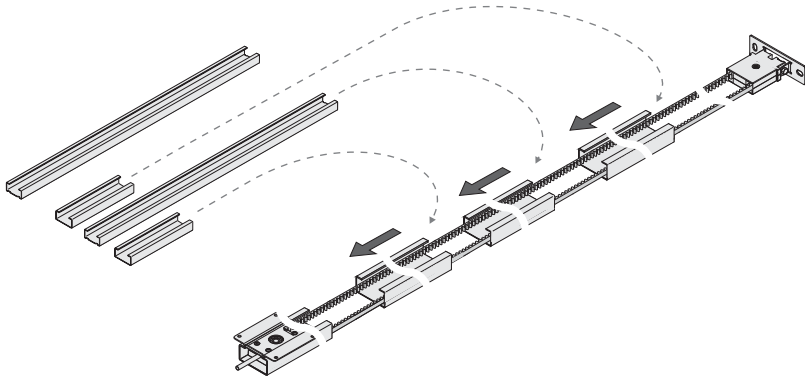

2

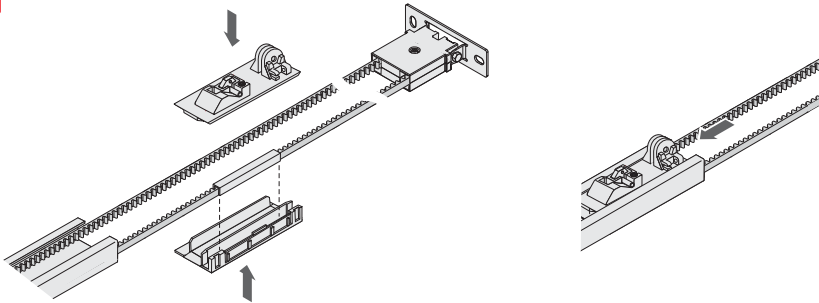

3

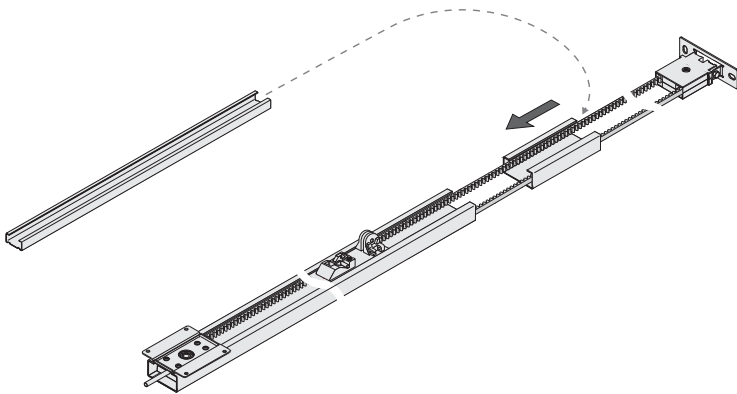

Assemble the drive unit as shown in the figures.

8. Tensioning the belt

A	B
TOP803T3	4-6mm
TOP803T4	6-9mm

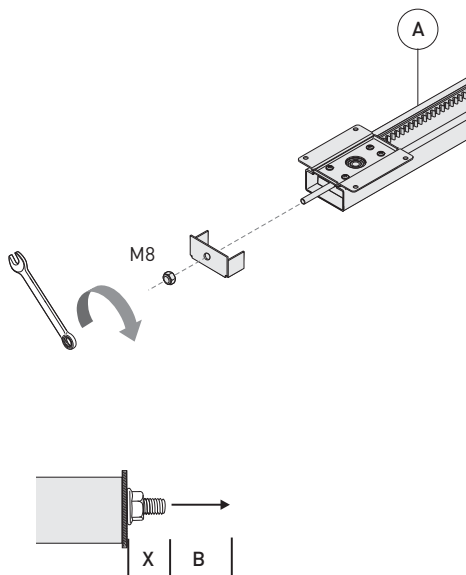
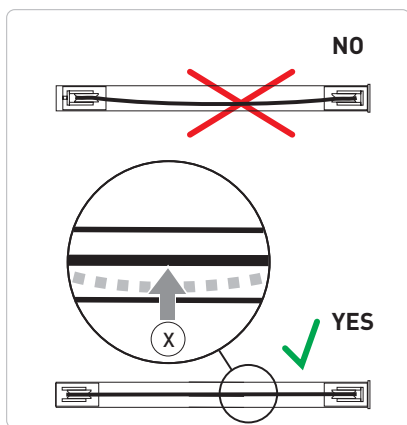

Tighten the locking nut until the belt is correctly tensioned [X] within the guide.
Adjust the dimension [B] according to the type of guide used.

9. Assembling the automation

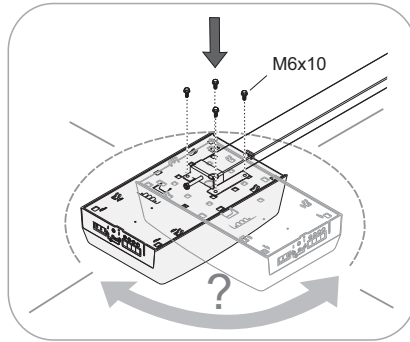
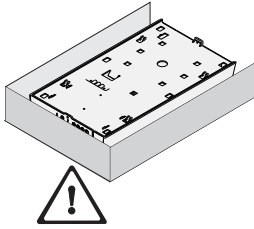

Fit the pulling unit to the drive system.
The pulling unit can be rotated by 90°.

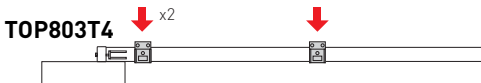
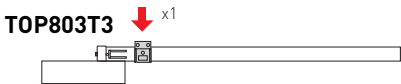
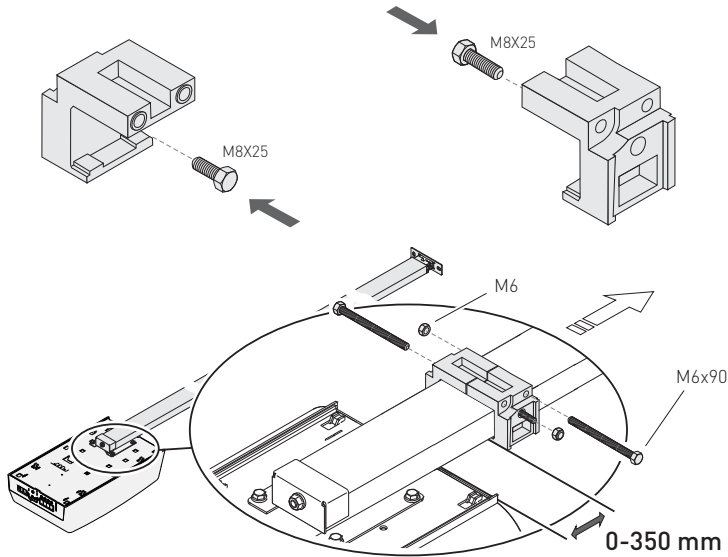

10. Mechanical installation

Select and mark the point where the guide will be mounted on the wall and ceiling.

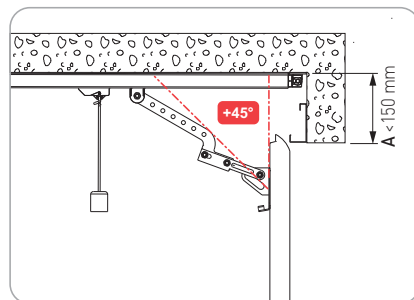
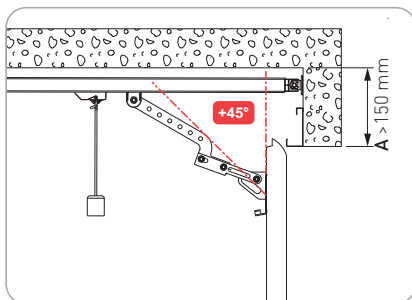
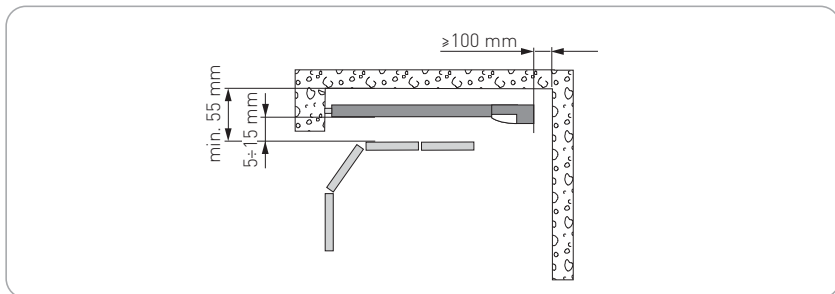
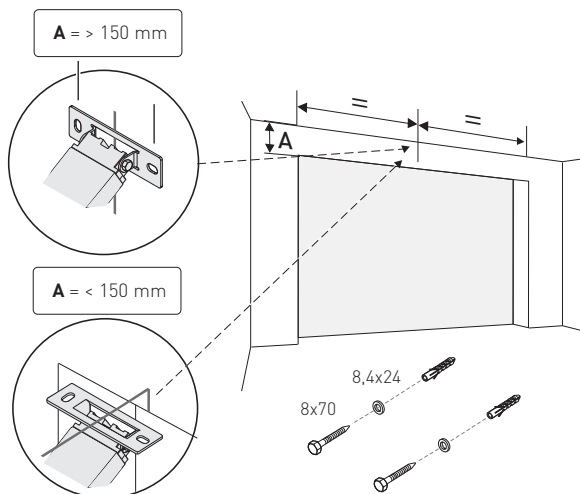

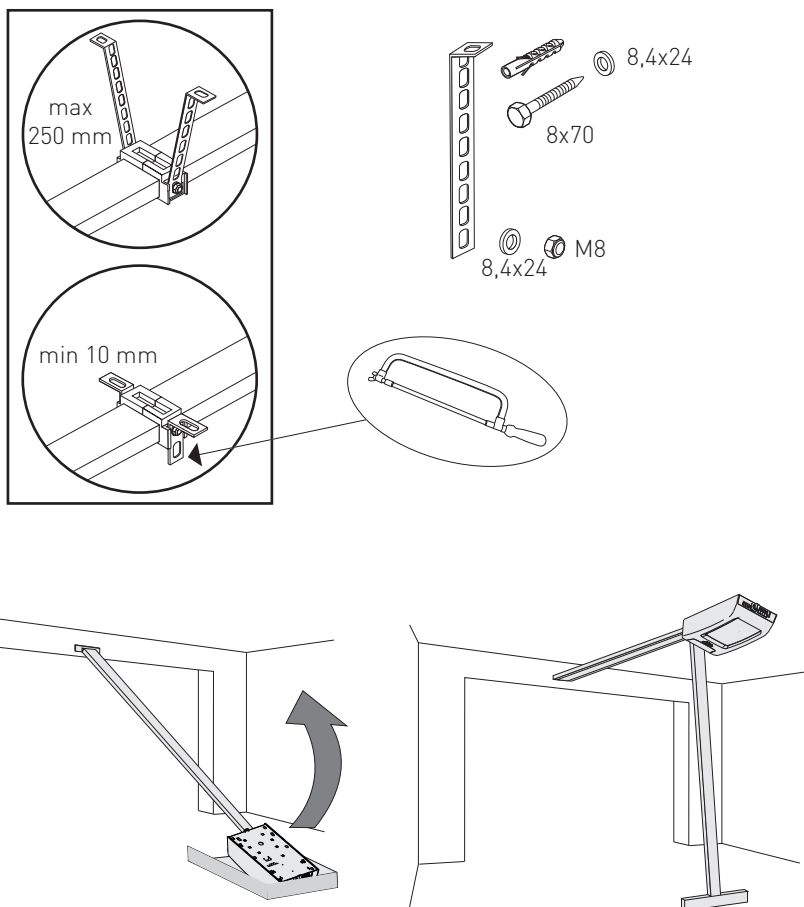

- Check the stability of the door, and make sure it moves smoothly.
- It must be possible to open and close the door easily and smoothly by hand.
- The automation must only be installed in dry places.
- With the pulling unit on the ground, fix the guide to the wall.
- Raise the pulling unit and bend the brackets as necessary (any excess parts can be removed), then attach to the ceiling.



WARNING: the pulling unit is heavy, so be very careful when raising it.

11. Assembling and fastening the arm

1

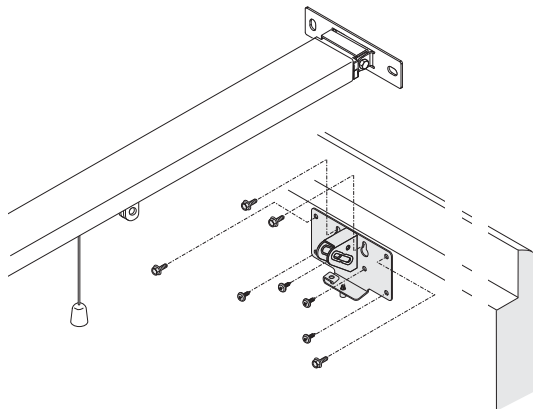

2

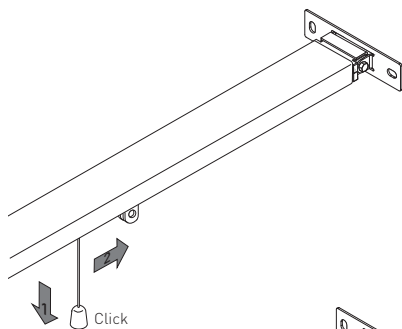

3

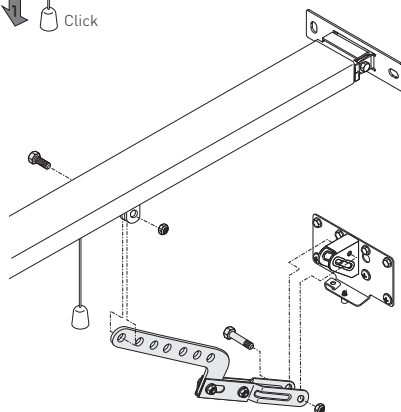

- Fix the retention bracket to the upper part of the door.
- Unlock the automation by pulling the cord downwards until the lock release lever is triggered.
- Bring the carriage near the closed door, and fix the arm as shown in figure 3.

12. Installing the adapter for TOPSB tilting doors

In applications for tilting doors, you must use the TOPSB adapter.



For more information, refer to the TOPSB installation manual.

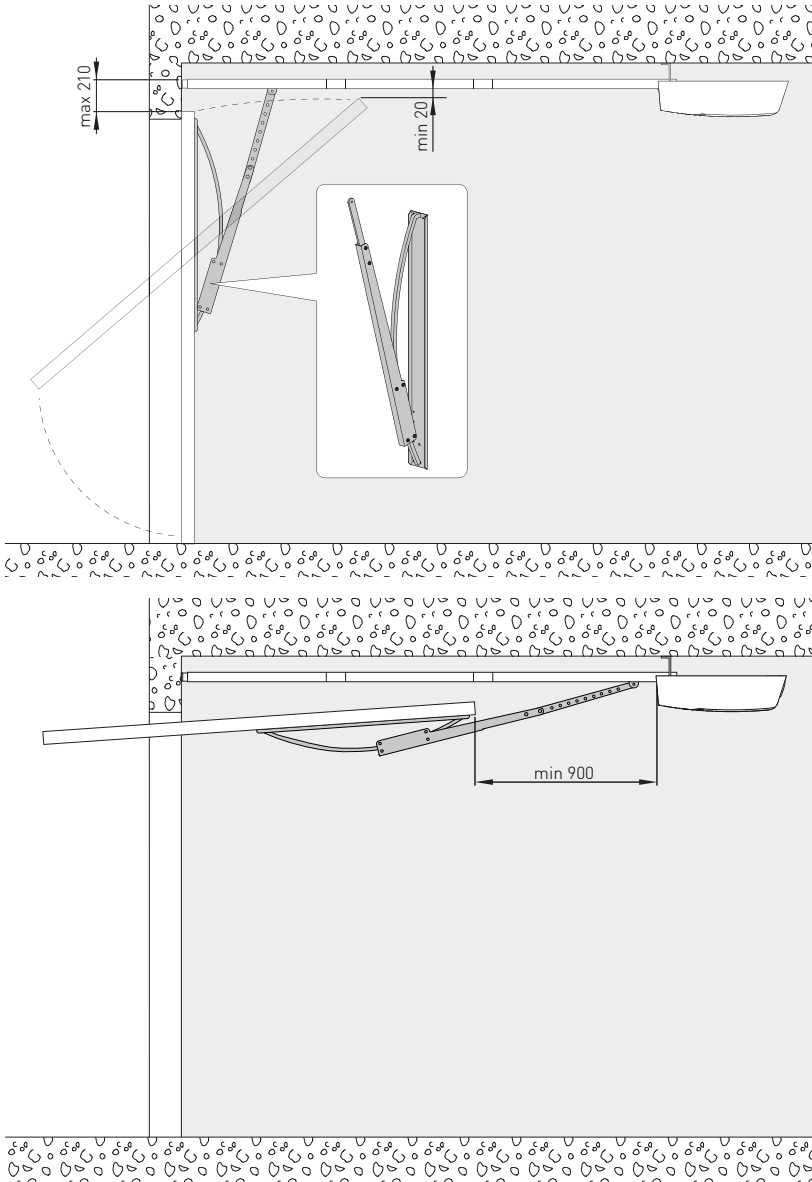

13. Electrical connections TOP603H

Installation, electrical connections and adjustments must be performed by qualified personnel, in accordance with Good Working Methods and in compliance with the current regulations. The automation must be installed in compliance with Standards EN 12453, EN 12445 and EN 12635. The safety devices must be working properly.

Garages without a second entrance must be equipped with an external emergency release device (to be ordered separately).

If there is a pedestrian door incorporated into the garage door, it must be equipped with a safety device that prevents it being activated when the garage door is open.  This safety device must be connected to the EMERGENCY STOP.



In the external automation section, the connections to the mains power supply and any other low voltage wires (230V) must be made on an independent channel separated from the connections to the command and safety devices (SELV = Safety Extra Low Voltage).

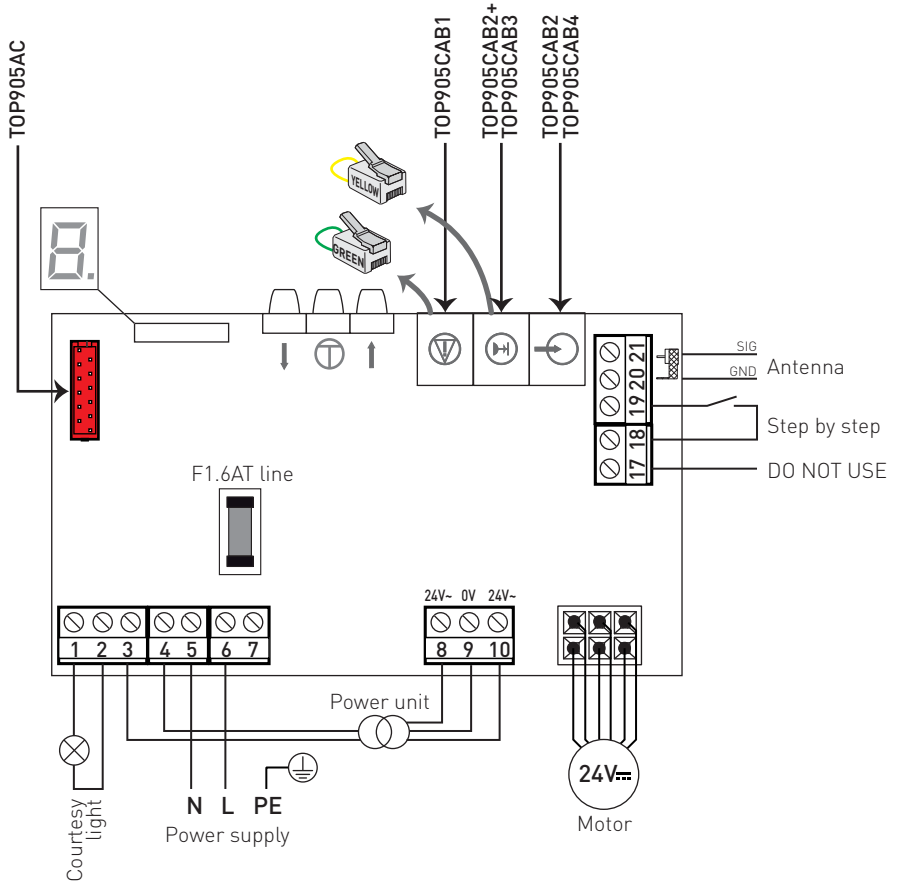

13.1 Wiring the accessories

There are two ways to connect the TOP operator to the stop and open commands and the photocells:

1. By using pre-wired cables (ref. TOP905CAB1, TOP95CAB2, TOP905CAB3, TOP905CAB4), not included in the operator kit.
2. By using made-to-measure cables.

13.1.1 Pre-wired cables

For pre-wired cables, follow the instructions below:

TOP905CAB1 (10 m) - STOP command



WARNING: use EXCLUSIVELY for the STOP command.

TOP905CAB2 (10 m) - OPEN command for powered accessories



TOP905CAB2 (10 m) + TOP905CAB3 (13 m) - Connection of PHOTOCELLS

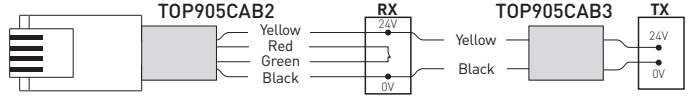

TOP905CAB4 (10 m) - OPEN contact for NON-powered accessories

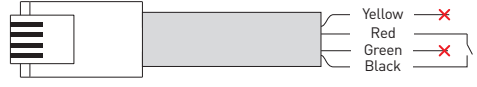



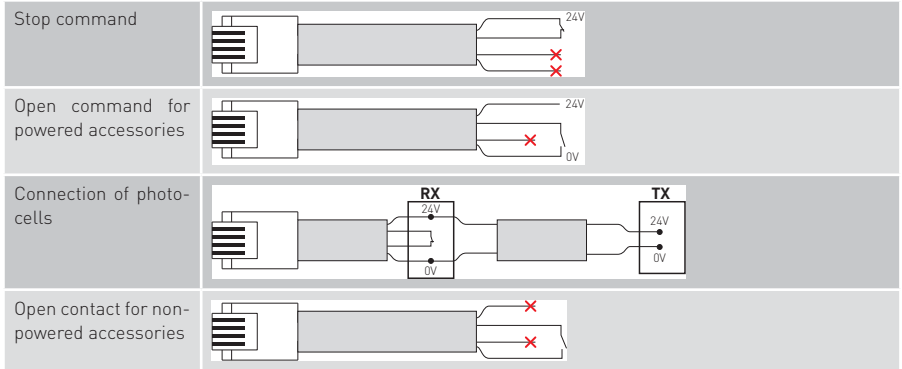

13.1.2 Preparation of made-to-measure cables



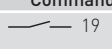

Made-to-measure cables can be made using a cable with the following characteristics: 4-wire telephone cable AWM20251 VW-1 60°C 150V 4x26AWG (L = 20 m max).
 After crimping the RJ11 4P4C connector, the cables must be connected as indicated below:



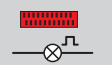

13.2 Commands TOP603H

Command	Function	Description
	STEP-BY-STEP	The closure of the contact activates a sequential opening or closing operation: opening-stop-closing-stop.
	OPENING	With automatic closure enabled (parameter b4), the closure of the contact activates an opening operation.
	STEP-BY-STEP	The closure of the contact activates a sequential opening or closing operation: opening-stop-closing-stop.
	OPENING	With automatic closure enabled (parameter b4), the closure of the contact activates an opening operation.
	STOP	The opening of the safety contact causes the current movement to stop, and the automatic closure is disabled.
	REVERSAL SAFETY	The opening of the safety contact triggers a reversal of the movement (reopening) during the closing operation, and the flashing of the courtesy light. After the 3rd consecutive reversed movement, the automatic closure is disabled (if active) and the courtesy light flashes for about 10 min.

13.3 Outputs and accessories TOP603H

Output	Value - Accessories	Description
	24 V $\overline{\text{=}}$ / 0.3A for 2s 24 V $\overline{\text{=}}$ / 0.08A continuous	Power supply to accessories. The maximum continuous absorption refers to all the accessories installed. Yellow wire (+24V) and black wire (-0V) with TOP905CAB2.
	LAMP 230 V \sim / 25W	Flashing light (with TOP905AC). Activated during opening and closing operations.
	max 1.6A	Electric lock (with TOP905AC). Activated for 1s at each start (even with the door open).
	max 230 V \sim / 60W	Courtesy light. Activated for 120s at the end of every operation. An additional E14 courtesy light can be connected (in parallel) - max 60W or equivalent. DO NOT CONNECT fluorescent tubular lamps. NB: some energy-saving lamps may interfere with the radio signal.
	GOL148REA	Antenna Connect the supplied antenna wire (345mm), or alternatively the GOL148REA antenna, using an RG58 coaxial cable.

 **WARNING:** make a jumper for all unused NC contacts.

 Keep the **YELLOW** and/or **GREEN** connectors if accessories are to be connected.

14. Commands and indications

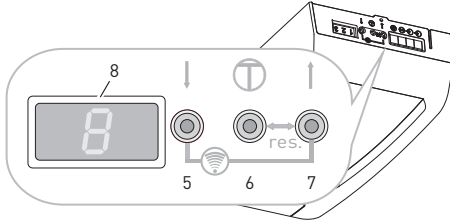



5	Button for door closure / decreased value
6	Menu button / confirm (stroke memorisation)
7	Button for door opening / increased value
8	Display



The procedures and adjustments can only be carried out when the display is in mode A, B or C.

Status messages

- A  door fully OPEN
- B  door between the two end stop positions
- C  door fully CLOSED



While the door is OPENING, the display visualises:



While the door is CLOSING, the display visualises:



14.1 Deleting the memorised stroke values

If you press the  [6] and  [7] keys simultaneously for a few seconds, the display flashes , the stroke values are deleted, and the display visualises L ... 4.

NB: the remote controls are not deleted.

14.2 Restoring the factory settings

Remove the plug from the  connector, then press the  [6] and  [7] keys simultaneously for 12s.

The display flashes , first slowly and then more quickly.

All the adjustments previously made are deleted, and the factory values are restored.

The stroke values are deleted.

Reconnect the plug to the  connector.





The display visualises L ... 4.

NB: the remote controls are not deleted.

15. Self-learning of the stroke TOP603H

WARNING: when an automation stroke self-learning operation is carried out, the obstacle detection device is not active.

NB: the self-learning operation can only be carried out during the initial installation or following an automation RESET. Do not press any keys during this procedure.



1. Turn on the power supply.
 - The display flashes L ... 4.
 - Press and hold the  [7] button. The door will open.
 - The display flashes L ... 4.
 - Release the button when the required opening position is reached.
 - Use the  [7] and  [5] buttons to correct the position if necessary.
 - The courtesy light flashes 4 times during the operation L ... 4.
2. Press the  [6] button. The display flashes L ... 3.
 - The automation memorises the opening position and begins a closing operation.
 - The courtesy light flashes 3 times.
 - When the door reaches the closed position, the display flashes L ... 2. The courtesy light flashes twice.
 - The automation opens automatically as far as the open position. The display flashes L ... 1. The courtesy light flashes once.
 - The automation automatically recloses as far as the closed position, the display visualises  and the door re-opens. The lamp does not flash.
3. The self-learning procedure is complete when the door is open and the courtesy light is ON.

NB: in certain cases, especially when the door moves very smoothly or the traction unit is not connected to the door, the automatic stroke self-learning procedure may fail. This brings the procedure back to the initial display condition L ... 4.

In this situation, you must modify parameter b3 = 0 (see ch. 17-18) to guarantee the correct memorisation of the stroke.

Self-learning of the stroke with a remote transmitter

When the automation is delivered or reset, the remote transmitter assumes the following functions:

- (1) has the same function as 
- (3) has the same function as 
- (2) or (4) has the same function as 



For the self-learning of the stroke, refer to the procedure explained above.

Once the self-learning phase is complete, key [1] is used to command the door. The other keys can be used to command other similar automations or other radio receivers.

16. Memorising / Deleting remote controls

16.1 Memorising remote controls via the control panel

1. Press the \uparrow [7] and \downarrow [5] keys simultaneously for about 1 s. The display flashes **F**.
2. Press the required key on the remote control.
 - The display indicates **F** for about 1 s, and the remote control is memorised.
 - The function of the memorised key is OPEN-STOP-CLOSE-STOP.

NB: with automatic closure enabled (parameter b4), the function of the remote control is OPENING.

16.2 Memorising remote controls from a distance

1. Press the PRG of a previously memorised GOL4 transmitter for 5 seconds (within the range of the receiver) until the LED lights up.
2. Press any one of the CH keys of the new transmitter.
 - The new transmitter can memorise the same keys as the existing transmitter.

NB: be careful not to accidentally memorise your neighbours' transmitters.

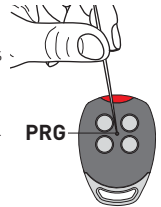

16.3 Deleting remote controls

1. Press the \uparrow [7] and \downarrow [5] buttons simultaneously for more than 6 seconds. The display flashes **F**, first slowly and then more quickly.
 - All the remote controls are deleted.

17. Adjusting the parameters

















1. Press the menu button M [6] for more than 1.5 s. The display goes to the adjustments menu or to the last parameter adjusted. The 2-character menu name flashes. For example A ... 0.
2. Select the required parameter using the \uparrow [7] and/or \downarrow [5] buttons.
3. Press the menu button M [6] for less than 1.5 s. The display indicates the value of the selected parameter. For example, 0.
4. Alter the value using the \uparrow [7] and/or \downarrow [5] buttons. The new value is automatically memorised.
5. Press the M [6] button for less than 1.5 s. The display returns to the selected parameter.
 - To quit the adjustment mode, press the M [6] button for more than 1.5 s.
 - The adjustment mode is automatically quit after 15 s of inactivity.







NB: while the adjustment mode is active, the automation cannot accept any commands.

WARNING: if the programming menu values from A0 to A4 are modified, the display visualises L .. 4 and you must repeat the learning procedure (see chapter 15).

18. Parameters TOP603H

Menu	Function, setting range, unit	Value	Factory settings
A0	Deceleration distance on opening 0 = 0cm 1 = 7cm 2 = 14cm ... 9 = 63cm	0 - 9	2
A1	Deceleration distance on closing 0 = 0cm 1 = 7cm 2 = 14cm ... 9 = 63cm	0 - 9	4
A2	Deceleration speed on closing (mm/s) 0 = 50mm/s 9 = 140mm/s	0 - 9	5
A3	Disengagement on the closing stop 0 = disabled 1 = enabled	0 - 1	1
A4	Direction selection 0 = disabled 1 = enabled This setting is only possible if the EMERGENCY STOP connector (1, green) is disconnected.	0 - 1	0
A5	Thrust adjustment on obstacles during opening 0 - minimum thrust 9 - maximum thrust	0 - 9	3
A6	Thrust adjustment on obstacles during closing 0 - minimum thrust 9 - maximum thrust NB: after detecting an obstacle during a closing operation, the door reverses its stroke for about 800mm. Automatic closure is disabled (if active) and the courtesy light flashes for about 10 min. WARNING: to ensure the closing thrust force values return within the limits established by Standard EN12453, you must set a value of 1 for parameter A6. This operation must be carried out by qualified personnel.	0 - 9	3
A7	Door type: 0 = sectional door 1 = side sectional door with disengagement on obstacle during opening too 2 = side sectional door / tilting door with soft start If A7 has been modified, perform a reset then repeat the learning operation (chapter 15).	0 - 2	0
A8	Early switch-on of courtesy light for opening and closing (sec.) 0 = disabled 1 = min 2 sec 8 = max 16 sec	0 - 8	0

Menu	Function, setting range, unit	Value	Factory settings
	Auxiliary card 0= without TOP905AC 1= with TOP905AC	0 - 1	
	Relay 1 (with auxiliary card TOP905AC) if A9 = 1 0= no function 1= electric lock (activated for 1 s at each start) 2= flashing light (activated when the motor is moving) 3= photocell test (transmitter voltage interrupted) 4= door OPEN (activated with door fully open) 5= door CLOSED (activated with door fully closed) 6= green light (activated with door fully open) 7= red light (deactivated with door fully open)	0 - 7	
	Relay 2 (with auxiliary card TOP905AC) if A9 = 1 0= no function 1= electric lock (activated for 1 s at each start) 2= flashing light (activated when the motor is moving) 3= photocell test (transmitter voltage interrupted) 4= door OPEN (activated with door fully open) 5= door CLOSED (activated with door fully closed) 6= green light (activated with door fully open) 7= red light (deactivated with door fully open)	0 - 7	
	Closing edge protection (with auxiliary card TOP905AC) 0= disabled 1= optic edge FUTURE USE	0 - 1	
	Detection of stroke with little weight / friction 0= door with little weight / low friction 1= door with standard weight / normal friction	0 - 1	
	Selection of automatic closure 0= disabled 1= 10 sec 2= 30 sec 3= 1 min ... 5 = 3 min 6= 5 min ... 8 = 15 min With automatic closure enabled, the OPEN/STOP/CLOSE/STOP command becomes a simple OPENING command. The enabling of automatic closure is visualised on the display with  (point) flashing with the door open, or fixed after a step-by-step STOP command. The step-by-step STOP commands given when automatic closure is enabled are not permanent.	0 - 8	
	DO NOT USE		
	Maintenance alarm 0 = disabled 1..9 (1000 door operations) Example: 5 = 5000 door operations When the maintenance interval has expired, the courtesy light flashes after every movement. A new maintenance alarm setting will reset the counter.	0 - 9	

Menu	Function, setting range, unit	Value	Factory settings
	Number of the control panel version: 8 digits are visualised twice in succession, preceded by "-". Example: -04200510 indicates: Version: 04, Date: 20.05.10		
	Help mode 0= control panel free (menu items adjustable) 1= control panel locked (menu items not adjustable) 2= data output (auxiliary card) - FUTURE USE This setting is only possible if the EMERGENCY STOP connector (1, green) and the photocell connector (2, yellow) are disconnected.	0 - 2	
	Operation count 6 digits are visualised twice in succession, preceded by a  (dash). Example: -008000 indicates: 8,000 strokes		
	DO NOT USE		

19. Electrical connections TOP903H

Installation, electrical connections and adjustments must be performed by qualified personnel, in accordance with Good Working Methods and in compliance with the current regulations. The automation must be installed in compliance with Standards EN 12453, EN 12445 and EN 12635.

The safety devices must be working properly.

Garages without a second entrance must be equipped with an external emergency release device (to be ordered separately).

If there is a pedestrian door incorporated into the garage door, it must be closed and equipped with a safety device that prevents it being activated when the garage door is open. ⚠ This safety device must be connected to the EMERGENCY STOP input.



In the external automation section, the connections to the mains power supply and any other low voltage wires (230V) must be made on an independent channel separated from the connections to the command and safety devices (SELV = Safety Extra Low Voltage).

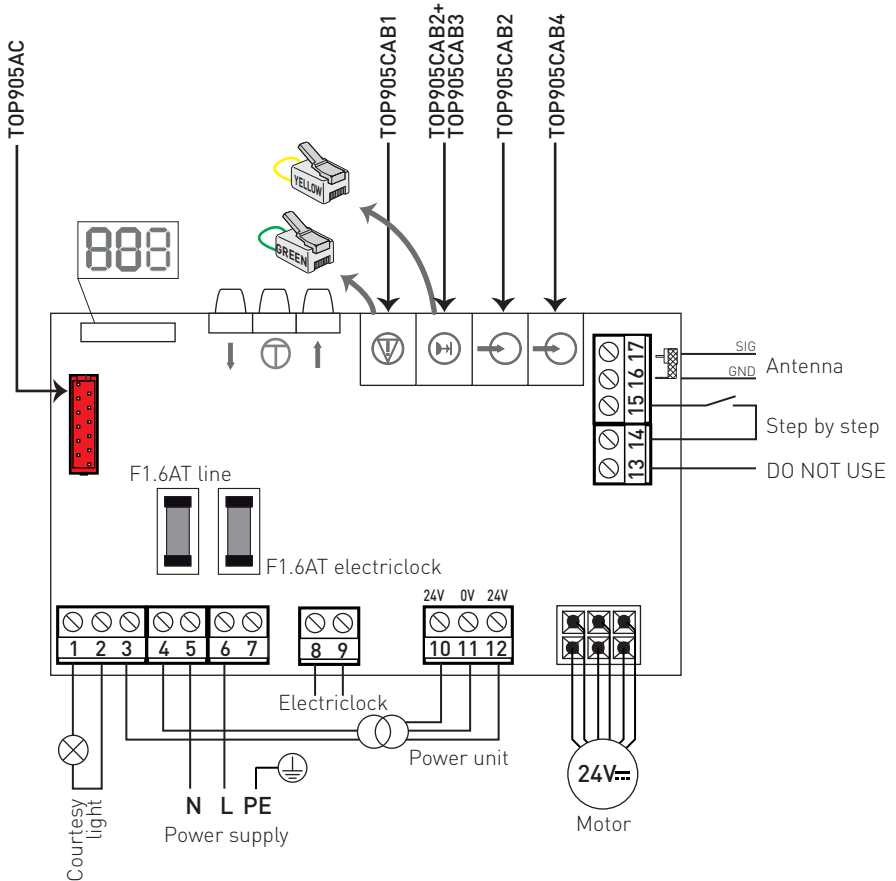

TOP903H

19.1 Wiring the accessories

There are two ways to connect the TOP operator to the stop and open commands and the photocells:

1. By using pre-wired cables (ref. TOP905CAB1, TOP95CAB2, TOP905CAB3, TOP905CAB4), not included in the operator kit.
2. By using made-to-measure cables.

19.1.1 Pre-wired cables

For pre-wired cables, follow the instructions below:

TOP905CAB1 (10 m) - STOP command

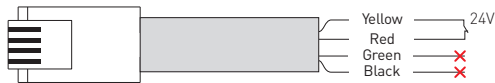

WARNING: use EXCLUSIVELY for the STOP command.

TOP905CAB2 (10 m) - OPEN command for powered accessories



TOP905CAB2 (10 m) + TOP905CAB3 (13 m) - Connection of PHOTOCELLS

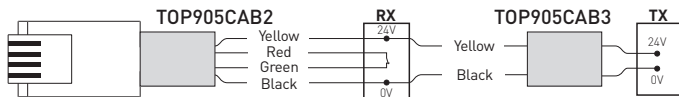

TOP905CAB4 (10 m) - OPEN contact for NON-powered accessories

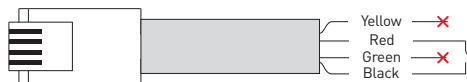



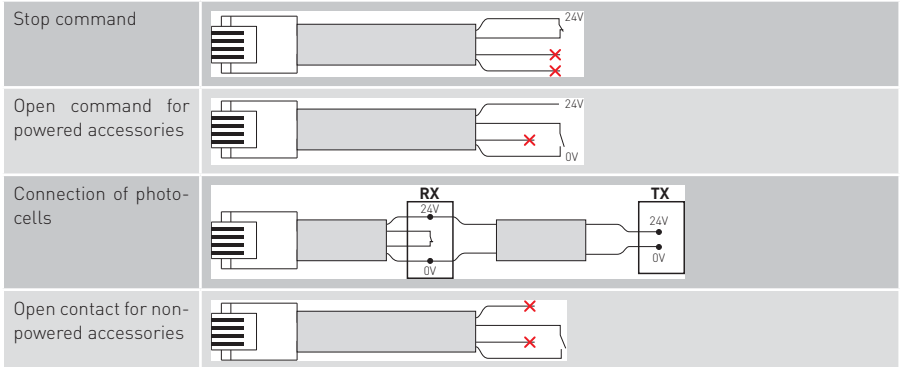

19.1.2 Preparation of made-to-measure cables

Made-to-measure cables can be made using a cable with the following characteristics: 4-wire telephone cable AWM20251 VW-1 60°C 150V 4x26AWG (L = 20 m max).





After crimping the RJ11 4P4C connector, the cables must be connected as indicated below:



19.2 Commands TOP903H

Command	Function	Description
14  15	NO	STEP-BY-STEP The closure of the contact activates a sequential opening or closing operation: opening-stop-closing-stop.
	OPENING	With automatic closure enabled (parameter b4), the closure of the contact activates an opening operation.
	NO	STEP-BY-STEP The closure of the contact activates a sequential opening or closing operation: opening-stop-closing-stop.
	OPENING	With automatic closure enabled (parameter b4), the closure of the contact activates an opening operation.
	ADDITIONAL FUNCTIONS	See parameter C6.
	NO	STEP-BY-STEP The closure of the contact activates a sequential opening or closing operation: opening-stop-closing-stop.
	OPENING	With automatic closure enabled (parameter b4), the closure of the contact activates an opening operation.
	ADDITIONAL FUNCTIONS	See parameter C6.
	NC	STOP The opening of the safety contact causes the current movement to stop, and the automatic closure is disabled (if C5=000).
	NC	REVERSAL SAFETY The opening of the safety contact triggers a reversal of the movement (reopening) during the closing operation, and the flashing of the courtesy light. After the 3rd consecutive reversed movement, the automatic closure is disabled (if active) and the courtesy light flashes for about 10 min.

19.3 Outputs and accessories TOP903H

Output	Value - Accessories	Description
	24 V $\overline{\text{=}}$ / 0.3A for 2s 24 V $\overline{\text{=}}$ / 0.08A continuous	Power supply to accessories. The maximum continuous absorption refers to all the accessories installed. Yellow wire (+24V) and black wire (-0V) with TOP905CAB2.
	LAMP 230 V~ / 25W	Flashing light (with TOP905AC). Activated during opening and closing operations.
8  9	max 1.6A	Electric lock. Activated for 1s at each start (even with the door open).
1  2	max 230V~ / 60W	Courtesy light. Activated for 120s at the end of every operation. An additional E14 courtesy light can be connected (in parallel) - max 60W or equivalent. DO NOT CONNECT fluorescent tubular lamps. NB: some energy-saving lamps may interfere with the radio signal.
16  17	GOL148REA	Antenna Connect the supplied antenna wire (345mm), or alternatively the GOL148REA antenna, using an RG58 coaxial cable.



WARNING: make a jumper for all unused NC contacts.



Keep the **YELLOW** and/or **GREEN** connectors if accessories are to be connected.

20. Commands and indications

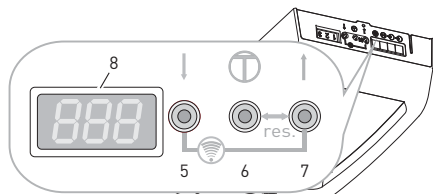

5	Button for door closure / decreased value
6	Menu button / confirm (stroke memorisation)
7	Button for door opening / increased value
8	Display



The procedures and adjustments can only be carried out when the display is in mode A, B or C.

Status messages

A door fully OPEN

B door between the two end stop positions

C door fully CLOSED

While the door is OPENING, the display visualises:

C B A .

While the door is CLOSING, the display visualises:

A B C .

20.1 Deleting the memorised stroke values

If you press the [6] and [7] keys simultaneously for a few seconds, the display flashes , the stroke values are deleted, and the display visualises L4.

NB: the remote controls are not deleted.

20.2 Restoring the factory settings

Remove the plug from the connector, then press the [6] and [7] keys simultaneously for 12s.

The display flashes , first slowly and then more quickly.

All the adjustments previously made are deleted, and the factory values are restored.

The stroke values are deleted.

Reconnect the plug to the connector.

The display visualises L4.

NB: the remote controls are not deleted.

21. Self-learning of the stroke TOP903H

WARNING: when an automation stroke self-learning operation is carried out, the obstacle detection device is not active.

NB: the self-learning operation can only be carried out during the initial installation or following an automation RESET. Do not press any keys during this procedure.

1. Turn on the power supply.
 - The display flashes L4.
 - Press and hold the ↑ [7] button. The door will open.
 - The display flashes L4.
 - Release the button when the required opening position is reached.
 - Use the ↓ [5] button to correct the position if necessary.
 - The courtesy light flashes 4 times during operation L4.
2. Press the Ⓢ [6] button. The display flashes L3.
 - The automation memorises the opening position and begins a closing operation.
 - The courtesy light flashes 3 times.
 - When the door reaches the closed position, the display flashes L2. The courtesy light flashes twice.
 - The automation opens automatically as far as the open position. The display flashes L1. The courtesy light flashes once.
 - The automation automatically recloses as far as the closed position, the display visualises c [] and the door re-opens. The lamp does not flash.
3. The self-learning procedure is complete when the door is open and the courtesy light is ON.

NB: in certain cases, especially when the door moves very smoothly or the traction unit is not connected to the door, the automatic stroke self-learning procedure may fail. This brings the procedure back to the initial display condition L4.

In this situation, you must modify parameter b3 = 000 (see ch. 23-24) to guarantee the correct memorisation of the stroke.

Self-learning of the stroke with a remote transmitter

When the automation is delivered or reset, the remote transmitter assumes the following functions:

- (1) has the same function as ↑ (UP arrow)
- (3) has the same function as ↓ (DOWN arrow)
- (2) or (4) has the same function as Ⓢ (confirm/memorisation)



For the self-learning of the stroke, refer to the procedure explained above.

Once the self-learning phase is complete, key [1] is used to command the door. The other keys can be used to command other similar automations or other radio receivers.

22. Memorising / Deleting remote controls

22.1 Memorising remote controls via the control panel

1. Press the ↑ [7] and ↓ [5] keys simultaneously for about 1 s. The display flashes **8F0**.
2. Select the required function with the ↑ [7] and ↓ [5] keys.
 - The display indicates **8F0 - 8F8**
 - Press the required key on the remote control.
 - The display indicates **8F0 - 8F8** for about 1 s, and the remote control is memorised.
 - The function of the memorised key is:
 - F0 = OPEN-STOP-CLOSE-STOP
 - F1 = OPEN-STOP-OPEN-STOP
 - F2 = CLOSE-STOP-CLOSE-STOP
 - F3 = STOP
 - F4 = PARTIAL OPENING
 - F5 = COURTESY LIGHT ON or RESTART SWITCH-ON TIME
 - F6 = COURTESY LIGHT ON/OFF
 - F7 = OPEN
 - F8 = CLOSE

NB: with automatic closure enabled (parameter b4), the **8F0** function activates an OPENING operation and the STOP of the other functions is not permanent.

22.2 Memorising remote controls from a distance

1. Press the PRG of a previously memorised GOL4 transmitter for 5 seconds (within the range of the receiver) until the LED lights up.
2. Press any one of the CH keys of the new transmitter.
 - The new transmitter can memorise the same keys as the existing transmitter.

NB: be careful not to accidentally memorise your neighbours' transmitters.

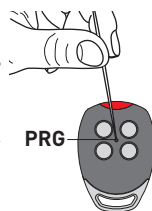

22.3 Deleting remote controls

1. Press the ↑ [7] and ↓ [5] buttons simultaneously for more than 6 seconds. The display flashes **8F0**, first slowly and then more quickly.
 - All the remote controls are deleted.









22.4 Checking the radio reception level

The level of radio reception received can be visualised:

- Press the ↑ [7] and ↓ [5] keys simultaneously for about 1 s. The display flashes **8F0**.
- Press the ↑ [7] and ↓ [5] keys simultaneously again for about 1 s to see the radio level.
 - x = 0 no radio signal ... x = 8 high radio level

The visualisation of the radio level is deactivated when the two keys, ↑ [7] and ↓ [5], are pressed again for about 1 s.



















23. Adjusting the parameters

















1. Press the menu button  [6] for more than 1.5 s. The display goes to the adjustments menu or to the last parameter adjusted. The 2-character menu name flashes. For example, A0.
2. Select the required parameter using the  [7] and/or  [5] buttons.
3. Press the menu button  [6] for less than 1.5 s. The display indicates the value of the selected parameter. For example, 000.
4. Alter the value using the  [7] and/or  [5] buttons. The new value is automatically memorised.
5. Press the  [6] button for less than 1.5 s. The display returns to the selected parameter.
 - To quit the adjustment mode, press the  [6] button for more than 1.5 s.
 - The adjustment mode is automatically quit after 15 s of inactivity.











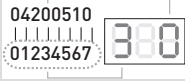





NB: while the adjustment mode is active, the automation cannot accept any commands.







WARNING: if the programming menu values from A0 to A4 are modified, the display visualises L4 and you must repeat the learning procedure (see chapter 21).

24. Parameters TOP903H

Menu	Function, setting range, unit	Value	Factory settings
	Deceleration distance on opening 000 = 0cm 001 = 7cm 002 = 14cm ... 009 = 63cm	000 - 009	
	Deceleration distance on closing 000 = 0cm 001 = 7cm 002 = 14cm ... 009 = 63cm	000 - 009	
	Deceleration speed on closing (mm/s) 000 = 50mm/s 009 = 140mm/s	000 - 009	
	Disengagement on the closing stop 000 = disabled 001 = enabled	000 - 001	
	Direction selection 000 = disabled 001 = enabled This setting is only possible if the EMERGENCY STOP connector (1, green) is disconnected.	000 - 001	
	Thrust adjustment on obstacles during opening 000 - minimum thrust 009 - maximum thrust	000 - 009	
	Thrust adjustment on obstacles during closing 000 - minimum thrust 009 - maximum thrust NB: after detecting an obstacle during a closing operation, the automation reverses its stroke for about 800mm. Automatic closure is disabled (if active) and the courtesy light flashes for about 10 min. WARNING: to ensure the closing thrust force values return within the limits established by Standard EN12453, you must set a value of 001 for parameter A6. This operation must be carried out by qualified personnel.	000 - 009	
	Door type: 000 = sectional door 001 = side sectional door with disengagement on obstacle during opening too 002 = side sectional door / tilting door with soft start If A7 has been modified, perform a reset then repeat the learning operation (chapter 21).	000 - 002	
	Early switch-on of courtesy light for opening and closing (sec.) 0 = disabled 1 = min 2 sec 8 = max 16 sec	001 - 008	

Menu	Function, setting range, unit	Value	Factory settings
	Auxiliary card 000 = without TOP905AC 001 = with TOP905AC	000 - 001	
	Relay 1 (with auxiliary card TOP905AC) if A9 = 1 000 = no function 001 = electric lock (activated for 1 s at each start) 002 = flashing light (activated when the motor is moving) 003 = photocell test (transmitter voltage interrupted) 004 = door OPEN (activated with door fully open) 005 = door CLOSED (activated with door fully closed) 006 = green light (activated with door fully open) 007 = red light (deactivated with door fully open)	000 - 007	
	Relay 2 (with auxiliary card TOP905AC) if A9 = 1 000 = no function 001 = electric lock (activated for 1 s at each start) 002 = flashing light (activated when the motor is moving) 003 = photocell test (transmitter voltage interrupted) 004 = door OPEN (activated with door fully open) 500 = door CLOSED (activated with door fully closed) 006 = green light (activated with door fully open) 007 = red light (deactivated with door fully open)	000 - 007	
	Closing edge protection (with auxiliary card TOP905AC) 000 = disabled 001 = optic edge FUTURE USE 002 = edge 8k2	000 - 001	
	Detection of stroke with little weight / friction 000 = door with little weight / low friction 001 = door with standard weight / normal friction	000 - 001	
	Selection of automatic closure 000 = disabled 001 = 5 sec - 010 = 50 sec 011 = 1 min - 040 = 30 min With automatic closure enabled, the OPEN/STOP/CLOSE/ STOP command becomes a simple OPENING command. The enabling of automatic closure is visualised on the display with  (3 points) flashing with the door open, or fixed after a step-by-step STOP command. The step-by-step STOP commands given when automatic clo- sure is enabled are not permanent.	000 - 008	
	DO NOT USE		
	Maintenance alarm 000 = disabled 001..009 (1,000 door operations) Example: 005 = 5,000 door operations When the maintenance interval has expired, the courtesy light flashes after every movement. A new maintenance alarm setting will reset the counter.	000 - 009	

Menu	Function, setting range, unit	Value	Factory settings
	Number of the control panel version: The digits from 000 to 007 are visualised in sequence. Example: version 04 of 20.05.10 		
	Help mode 000= control panel free, menu items adjustable 001= control panel locked, menu items not adjustable 002= data output (auxiliary card) - FUTURE USE This setting is only possible if the EMERGENCY STOP connector (1, green) and the photocell connector (2, yellow) are disconnected.	000 - 002	
	Operation count (not adjustable). The digits from 0 to 5 are visualised in sequence. Example: 8,000 operations 		
	DO NOT USE		
	Adjustment of automatic closing time after partial opening. 000 = disabled 001 = 5 secs... 010 = 50 secs 011 = 1 min ... 040 = 30 min	000 - 040	
	Selection of partial opening distance. 000 = 5 cm 100 = 500 cm	000 - 100	
	Adjustment of the courtesy light switch-on time. 000 = 0 sec 001 = 10 sec 060 = 600 sec	000 - 060	
	Adjustment of the automatic closing time after photocell intervention. 000 = disabled 001 = 0.5 s ... 019 = 9.5 s The count begins with the door fully open, and the closing operation is performed even with automatic closure (b4 / C1) disabled. WARNING: automatic closure is not disabled on the third consecutive direction reversal.	000 - 019	
	Selection of automatic closure after a STOP  000 = disabled 001 = enabled	000 - 001	

Menu	Function, setting range, unit		Value	Factory settings		
	Selection of additional command functions 		000 - 003			
		A 			b 	
	000	OPEN-STOP-CLOSE-STOP			PARTIAL OPENING	OPEN-STOP CLOSE-STOP CLOSE-STOP
	001	OPEN-STOP-CLOSE-STOP			OPEN-STOP-CLOSE-STOP	
	002	OPEN-STOP-OPEN-STOP			CLOSE-STOP-CLOSE-STOP	
003	OPEN	CLOSE				
	<p>Parking assistance (only with photocells installed). Once the door has opened and the car has passed through, the courtesy light flashes quickly 3 times when the photocells are disengaged to indicate that the door can be closed because the car is no longer in the passage opening. NB: you are advised to install internal photocells.</p> <p>000 = disabled 001 = enabled</p>		000 - 001			

25. Troubleshooting

Problem	Possible cause	Solution
The courtesy light flashes at regular intervals.	The door has detected an obstacle.	Check the door moves smoothly, and remove any obstacles.
The courtesy light flashes 4 times.	The door has not acquired the stroke.	Perform the learning procedure as explained in chapter 15 or 21.
The safety devices are not working.	Incorrect setting of the door or safety device.	Perform a reset and repeat the learning procedure (chapter 15 or 21). If the problem persists, contact Technical Service.
The automation doesn't work.	No supply voltage, or incorrect voltage. Faulty fuse.	Replace the fuse (see chapter 26 - Maintenance).
Faulty automation.	The carriage release is not correctly coupled. The toothed belt is not correctly tensioned. The door is blocked.	Check the release, belt or door movement.
The automation doesn't open.	STOP command activated or faulty. Alarm	Check the STOP command. If the problem persists, contact Technical Service.
The automation doesn't close.	Safety command activated or faulty. Alarm	Check the safety devices. If the problem persists, contact Technical Service.
The automation closes the door slowly (soft start) while the courtesy light is flashing.	The automation is performing the self-learning procedure (see ch. 15 or 21).	Wait until the procedure is completed. If the problem persists, contact Technical Service.
The automation stops during its stroke.	Make sure the door can move smoothly, and check the safety device is working properly.	Perform a reset and repeat the learning procedure (chapter 15 or 21).
The remote control doesn't work.	Flat batteries. LED not illuminated.	Replace the batteries.
	If the message of the function assigned to the transmission command is not visualised when the remote control is enabled.	Memorise the remote control (see ch. 16 or 22).
	Poor reception.	Install an optional antenna.
The remote control doesn't always work.	Radio level too weak. Radio interference from other transmission sources.	Check the radio level (see ch. 22 - TOP903H only).
The opening command doesn't work.	Faulty wall-mounting switch.	Check the wall-mounting switch and the connection wire.

25.1 Alarms

Self-diagnosis

After the learning procedure, after every motor start-up and after every 2.25 hours in the idle state, the system performs a self-diagnosis test.



TOP603H error messages

2	EEprom data
3	Current measurement
4	Photocell hardware
5	Switch-off thyristors
6	Switch-off relay
7	Watchdog test
8	ROM test
9	RAM test

TOP903H error messages

002	EEprom data
003	Current measurement
004	Photocell hardware
005	Switch-off thyristors
006	Switch-off relay
007	Watchdog test
008	ROM test
009	RAM test
010	SE test

If an alarm occurs, perform a RESET (see chapter 14.1 or 20.1).

NB: if the same error occurs in two successive self-diagnosis tests, the control system will be disabled (commands are rejected).

After about 1 minute, the system performs another self-diagnosis test.

If no errors are detected, the control system is enabled again.

If the error persists, perform a RESET of the factory settings (see chapter 14.2 or 20.2).

All the settings are deleted and the factory values are restored.

Launch a new learning procedure (see chapter 15 or 21) and make the new parameter adjustments (see chapter 18 or 24).

If the problem persists, contact Technical Service.

26. Maintenance

Monthly maintenance tasks

- Check the emergency release is working properly.
- Check the safety devices (if installed) are working properly.
- Check the obstacle detection function is working properly.

Six-monthly maintenance tasks

- Check the stability of the automation and make sure the screws and nuts are correctly tightened.

Replacing the fuse

Disconnect the mains plug.

- Remove the cover from the pulling unit.
- Take the faulty fuse S1 (S2) out of the fuse-holder and replace it. Make sure the new fuse is of the correct value.
- Replace the pulling unit cover.

Restore the mains connection.

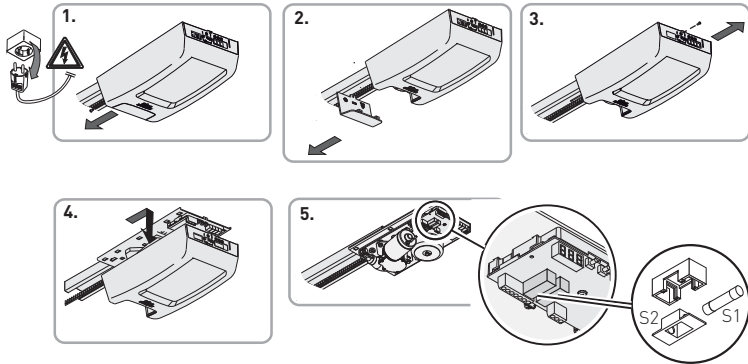

Replacing the courtesy light

Disconnect the mains plug.

- Remove the diffuser from the pulling unit.
- Replace the E14-40 W light bulb (max 60W or equivalent).

WARNING: handle with care since the light bulb may be very hot.

NB: some energy-saving bulbs may interfere with the radio signal.

- Replace the diffuser on the pulling unit.
- Restore the mains connection.

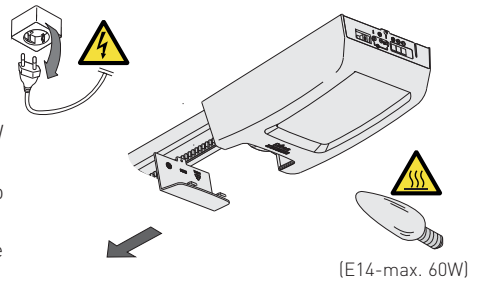

Replacing the remote control battery

Be extremely careful when replacing the battery.

Pay attention to the polarities.

Do not handle the battery with pliers or other tools, to avoid the risk of discharge or explosion.

To ensure an optimum performance, you are advised to replace the battery once a year or when you notice a substantial loss of range.

Dispose of used batteries in an environmentally-friendly way.

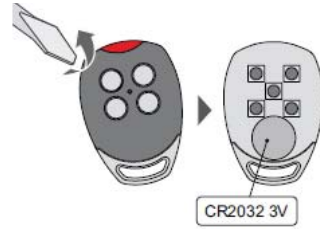

NB: for spare parts, see the spares price list.



Only use original spare parts when repairing or replacing products.

The installer must supply all information concerning the automatic, manual and emergency operation of the motorised door or gate, and must provide the user with the operating instructions.

The installer must prepare and keep a maintenance record showing all the routine and extraordinary maintenance work carried out.

All the rights concerning this material are the exclusive property of Entrematic Group AB.

Although the contents of this publication have been drawn up with the greatest care, Entrematic Group AB cannot be held responsible in any way for any damage caused by mistakes or omissions. We reserve the right to make changes without prior notice.

Copying, scanning or changing in any way is expressly forbidden unless authorised in writing by Entrematic Group AB.

ENTRE//MATIC



Entrematic Group AB
Lodjursgatan 10
SE-261 44, Landskrona
Sweden
www.ditecentrematic.com

