

## Entrematic E1T

Installation manual for control panel for automations with one 400 V three-phase motor.

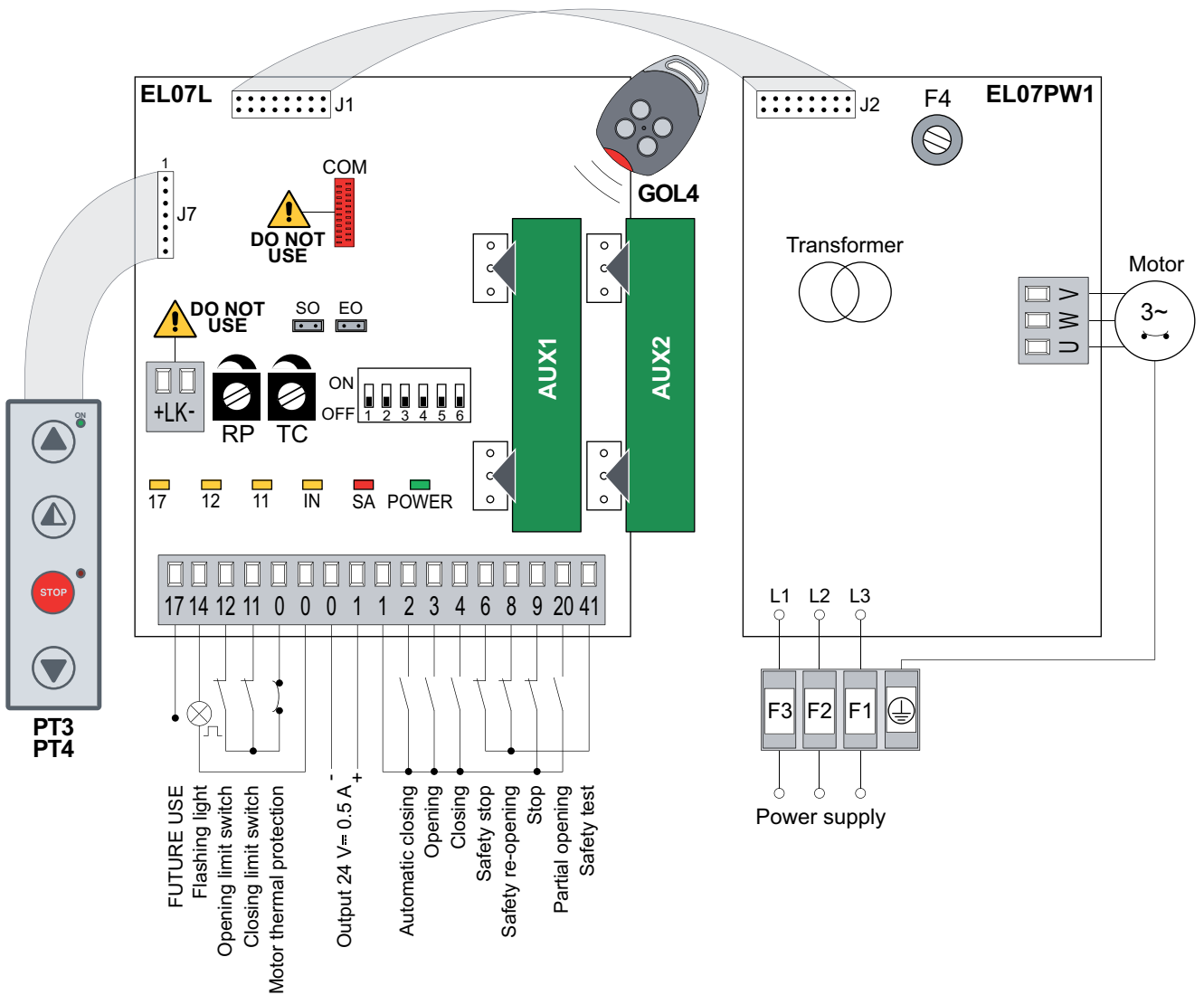

IP1897EN  
 Technical manual

## INDEX

Subject	Page
1. General safety precautions	3
2. EC declaration of conformity	4
3. Technical data	4
3.1 Applications	4
4. Connection of power supply	4
5. Commands	5
5.1 SOFA1-SOFA2 self-controlled safety edge	5
6. Outputs and accessories	6
7. Adjustments	7
8. Start-up	8
9. Troubleshooting	9
10. Example application for sliding gates	10
11. Example application for sectional overhead doors	11

## CAPTION



This symbol indicates instructions or notes regarding safety issues which require particular attention.



This symbol indicates informations which are useful for correct product function.



This symbol indicates instructions or notes intended for technical and expert personnel.



This symbol indicates operations not to be effected for not compromise the correct operation of the automation.



This symbol indicates options and parameters which are only available with the indicated item.



This symbol indicates options and parameters which are not available with the indicated item.

### All right reserved

All data and specifications have been drawn up and checked with the greatest care. The manufacturer cannot however take any responsibility for eventual errors, omissions or incomplete data due to technical or illustrative purposes.

## 1. GENERAL SAFETY PRECAUTIONS



This installation manual is intended for qualified personnel only.

The installation, the power connections and the settings must be completed in conformity with Good Working Methods and with the regulations in force.

Before installing the product, carefully read the instructions. Bad installation could be hazardous. The packaging materials (plastic, polystyrene, etc.) should not be discarded in the environment or left within reach of children, as these are a potential source of hazard.

Before beginning the installation check that the product is in perfect condition.

Do not install the product in explosive areas and atmospheres: the presence of flammable gas or fumes represents a serious threat to safety.

The safety devices (photocells, sensitive edges, emergency stop, etc.) must be installed taking into account: the provisions and the directives in force, Good Working Methods, the installation area, the functional logic of the system and the forces developed by the automation.



Before making power connections, check that the rating corresponds to that of the mains supply. A multipolar disconnection switch with a contact opening gap of at least 3 mm must be included in the mains supply. Check that upstream of the electrical installation an adequate residual current circuit breaker and an overcurrent cut out are fitted.

When requested, connect the automation to an effective earthing system carried out as indicated by current safety regulations.

During installation, maintenance and repair operations, cut off the power supply before opening the cover to access the electrical parts.



To handle electronic parts, wear earthed antistatic conductive bracelets. The manufacturer of the motorisation declines all responsibility in the event of components which are not compatible with the safe and correct operation of the product.

For repairs or replacements of products only original spare parts must be used.

## 2. EC DECLARATION OF CONFORMITY

Manufacturer: DITEC S.p.A.

Address: via Mons. Banfi, 3 21042 Caronno P.Ia (VA) - ITALY

declares that the control panel E1T is in conformity with the provisions of the following EC directives:

EMC Directive 2004/108/EC;

Low Voltage Directive 2006/95/EC.

Caronno Pertusella, 13-12-2010

Silvano Angaroni  
(Managing Director)

## 3. TECHNICAL DATA

	E1T
Power supply	400 V~ 50 Hz
F1 fuse	F8A
F2 fuse	F8A
F3 fuse	F8A
F4 fuse	F3,15A
Motor output	400 V~ 6 A
Accessories power supply	24 V= 0,5 A
Temperature	min -20 °C max +55 °C
Degree of protection	IP55
Box dimensions	238x357x120



*NOTE: the given operating and performance features can only be guaranteed with the use of DITEC accessories and safety devices.*

## 3.1 Applications

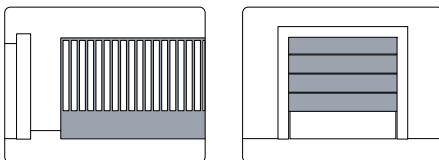

## 4. CONNECTION OF POWER SUPPLY

Fix the control panel permanently. Pass the cables along from the lower side of the container.

Before connecting the power supply, make sure the plate data correspond to that of the mains power supply. An omnipolar disconnection switch with minimum contact gaps of 3 mm must be included in the mains supply. Check that upstream of the electrical installation there is an adequate residual current circuit breaker and a suitable overcurrent cutout.

Use a H07RN-F 4G1,5 type electric cable and connect to the terminals L1, L2, L3, ⊕ (yellow/green) in the automation.

Secure the cable using the special cable clamp and remove the outer sheath near the terminal only.

Make sure there are no sharp edges that may damage the power supply cable.

Connection to the mains power supply, in the section outside the automation, is made with independent channels and separated from the connections to the control and safety devices.

## 5. COMMANDS

Command	Function	Description
1 — 2	N.O.	AUTOMATIC CLOSING The permanent closing of the contact enables automatic closing.
1 — 3	N.O.	OPENING With DIP1=ON, the closing of the contact activates the opening operation.
		STEP-BY-STEP With DIP1=OFF, the closing of the contact activates opening or closing operations in the following sequence: open-stop-close-open. <i>NOTE: if automatic closing is enabled, the stop is not permanent but lasts for a duration set by TC.</i>
1 — 4	N.O.	CLOSING The closing of the contact activates the closing operation.
41 — 6	N.C.	SAFETY STOP All operations are stopped and/or blocked when the safety contact is opened.
41 — 8	N.C.	REVERSE SAFETY CONTACT The opening of the safety contact triggers a reversal of motion (re-opening) during closing.
1 — 9	N.C.	STOP The opening of the safety contact stops the current operation.
		EMERGENCY STOP To enable the emergency stop function (e.g. with a specific red button), connect the opening and closing controls to terminal 9 instead of terminal 1 (9-3, 9-4, 9-20).
1 — 9	N.O.	HOLD-TO-RUN FUNCTION The opening of the 1-9 contact enables the hold-to-run function. - hold-to-run opening 1-3 [with DIP1=ON]; - hold-to-run closing 1-4. <i>NOTE: any safety devices, automatic closing and plug-in cards inserted in AUX1 and AUX2 are disabled.</i>
1 — 20	N.O.	PARTIAL OPENING The closing of the contact activates a partial opening operation of the duration set with the RP trimmer. Once the automation stops, the partial opening control performs the opposite operation to the one performed before stop.
0 — 11	N.C.	CLOSING LIMIT SWITCH The opening of the limit switch contact stops the closing operation.
0 — 12	N.C.	OPENING LIMIT SWITCH The opening of the limit switch contact stops the opening operation.
17		<b>FUTURE USE</b>











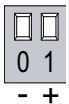





**WARNING:** make a jumper for all the N.C. contacts if not in use. The terminals with the same number are equal.



### 5.1 SOFA1-SOFA2 self-controlled safety edge



Command	Function	Description
	SAFETY TEST	Place the SOFA1-SOFA2 device into its housing for plug-in cards AUX1-AUX2. <i>NOTE: connecting terminal 41 enables a safety edge test cycle before every operation. If the test fails the SA led flashes and the test is repeated.</i>
1 — 6	N.C.	SAFETY STOP Connect the output contact of device SOFA1-SOFA2 to terminals 1-6 on the control panel (in series with the photocell output contact, if installed).
1 — 8	N.C.	REVERSE SAFETY CONTACT Connect the output contact of device SOFA1-SOFA2 to terminals 1-8 on the control panel (in series with the photocell output contact, if installed).



## 6. OUTPUTS AND ACCESSORIES











Output	Value - Accessories	Description
	24 V $\overline{\text{=}}$ 0.5 A	<b>Accessories power supply.</b> Power supply output for external accessories, including automation status lamp.
1  11	24 V $\overline{\text{=}}$ 3 W	<b>Open automation lamp.</b> The light switches off when the automation is closed.
1  12	24 V $\overline{\text{=}}$ 3 W	<b>Closed automation lamp.</b> The light switches off when the automation is open.
0  14	<b>LAMPH</b>	<b>Flashing light.</b> Activated during opening and closing operations.
<b>AUX1 AUX2</b>		The control panel has two housings for plug-in cards such as a radio receiver type, magnetic loops, etc. Plug-in card operating is selected using DIP1. <i>WARNING: the plug-in cards must be inserted and removed with the power supply disconnected.</i>
		<b>DO NOT USE</b>
		<b>DO NOT USE</b>
	400 V $\sim$ 6 A	<b>Three-phase motor.</b> Connect the contact of the motor circuit breaker in series to the limit switches. <i>NOTE: if the rotation direction of the motor is incorrect for the desired direction of movement, swap the L2 and L3 phases.</i>
	<b>PT3</b> 	<b>Membrane push-button panel.</b> Starts the opening operation. <i>NOTE: connect the push-button panel connector to J7. Connect the push-button panel to J7 rotated through 180° to activate the closing operation.</i>
	<b>PT3</b> 	<b>Membrane push-button panel.</b> Causes the blocking of the movement.
	<b>PT3</b> 	<b>Membrane push-button panel.</b> Starts the closing operation. <i>NOTE: connect the push-button panel connector to J7. Connect the push-button panel to J7 rotated through 180° to activate the closing operation.</i>
	<b>PT4</b> 	<b>Membrane push-button panel.</b> Starts the opening operation. <i>NOTE: the green LED on indicates the presence of the 24 V<math>\overline{\text{=}}</math> power supply.</i>
	<b>PT4</b> 	<b>Membrane push-button panel.</b> Starts the partial opening operation.
	<b>PT4</b> 	<b>Membrane push-button panel.</b> Starts and stops the STOP operation. <i>NOTE: the red LED on indicates that the STOP has been activated. The flashing red LED indicates that the safety devices have been activated.</i>
	<b>PT4</b> 	<b>Membrane push-button panel.</b> Starts the closing operation.

## 7. ADJUSTMENTS

	Description	OFF 	ON 
DIP1	<b>Command 1-3 operation.</b> <i>NOTE: it also sets operating mode of the plugin cards connected on AUX1 and AUX2.</i>	Step-by-step.	Opening.
DIP2	<b>Restore automatic closing time.</b>	50%	100%
DIP3	<b>3 seconds preflashing.</b>	Disabled during opening. Enabled only with automatic closing with TC >3 s.	Enabled for both opening and closing.
DIP4	<b>Application type.</b>	Sliding gate or sectional overhead door.	<b>DO NOT USE</b>
DIP5	<b>Dynamic brake.</b>	Disabled.	<b>DO NOT USE</b>
DIP6	<b>FUTURE USE</b>	/	/

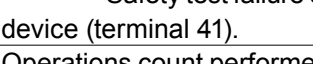
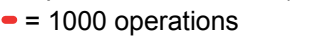
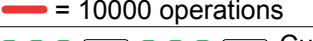
	Description	OFF 	ON 
SO	<b>Reversal safety switch function.</b>	With the automation blocked, if the contact 1-8 or 41-8 is open, it is possible to activate the opening operation.	With the automation blocked, if the contact 1-8 or 41-8 is open, any operation is impossible.
EO	<b>DO NOT USE</b>	/	/

Trimmer	Description
RP  0 s      30 s	<b>Partial opening adjustment.</b> From 0 to 30 s.
TC  0 s      120 s	<b>Setting automatic closing time.</b> From 0 to 120 s. <i>NOTE: after the activation of the stop command, once contact 1-9 has closed again, the automatic closing is only activated after a total, partial or step-by-step opening command.</i>

LED	On	Flashing
17 	<b>FUTURE USE</b>	
12 	0-12 limit switch contact is open.	/
11 	0-11 limit switch contact is open.	/
IN 	Receipt of command or change in status of a dip-switch.	/
SA 	At least one of the safety contacts is open.	<p> STOP operation activated by push-button panel PT4.</p> <p> Safety test failure on SOFA1-SOFA2 device (terminal 41).</p> <p>Operations count performed (only when control panel is switched on):</p> <p> = 1000 operations</p> <p> = 10000 operations</p>
POWER 	Power supply on.	<p> Current overload on flashing light output.</p> <p> Shortcircuiting of the flashing light driver.</p>

## 8. START-UP



**WARNING** *The operations in point 3 are performed without safety devices.  
The trimmer can only be adjusted with the automation idle.*

- 1- Make a jumper for the N.C. safety contacts.
- 2- Set DIP4=OFF.
- 3- Switch on and check that the automation is operating correctly with subsequent opening and closing commands.  
Check that the limit switches are activated.  
*NOTE: if the direction of rotation of the motor is incorrect for the desired direction of the automation, swap the L2 and L3 phases.*
- 4- Connect the safety devices (removing the relative jumpers) and check they work correctly.  
*WARNING: check that the working forces exerted by the door wings are compliant with EN12453-EN12445 regulations.*
- 5- If required, activate automatic closing using command 1-2 and adjust the time using the TC trimmer.
- 6- If required, activate partial opening using command 1-20 and adjust the time using the RP trimmer.
- 7- If required, connect the radio receiver to the relative AUX connector, program the transmitters as described in the relative manual and check that all elements function correctly.
- 8- Connect any other accessories and check they operate correctly.
- 9- Once the start-up and check procedures are completed, close the container.



**NOTE:** *in the event of servicing or if the control panel is to be replaced, repeat the start-up procedure.*



## 9. TROUBLESHOOTING

<b>Problem</b>	<b>Possible causes</b>	<b>Remedy</b>
The automation does not open or close.	No power. (POWER led off).	Check that the control panel is powered correctly.
	Short circuited accessories. (POWER led off).	Disconnect all accessories from terminals 0-1 (voltage must be 24 V $\overline{DC}$ ) and reconnect one at a time.
	Blown line fuses. (POWER led off).	Replace fuses.
	Safety contacts are open. (SA led on).	Check that the safety contacts are closed correctly (N.C.).
	Safety contacts not correctly connected or SOFA1-SOFA2 self-controlled safety edge not functioning correctly. (SA led flashing).	Check connections to terminals 6-8 on control panel and connections to the SOFA1-SOFA2 self-controlled safety edge.
	Release microswitch open (if present). (11 and 12 led on).	Check that the hatch is closed correctly and the microswitch makes contact (if present).
	The motor thermal overload switch is open. (11 and 12 led on).	Check the continuity of the thermal contact.
	Photocells are activated. (SA led on).	Check that the photocells are clean and operating correctly.
	The automatic closing does not work.	Check that contact 1-2 is closed.
External safety devices not activating.	Incorrect connections between the photocells and the control panel.	Connect N.C. safety devices together in series and remove any bridges on the control panel terminal board.

## 10. EXAMPLE APPLICATION FOR SLIDING GATES

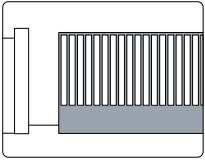

(Fig. 10.1) When the control panel is used in applications for sliding gates:

- set DIP4=OFF;
- connect opening and closing limit switches N.C. contacts to terminals 0-11-12.

With the above connections, when limit switches operate the wing stops.



**NOTE:** if the SOFA1-SOFA2 self-controlled safety edge is used, make the connections indicated on page 5.



**NOTE:** it is possible to use the remote control with step-by-step function and, at the same time, the terminal 3 with opening function, making the connections indicated in fig. 10.2 and setting DIP1=OFF.

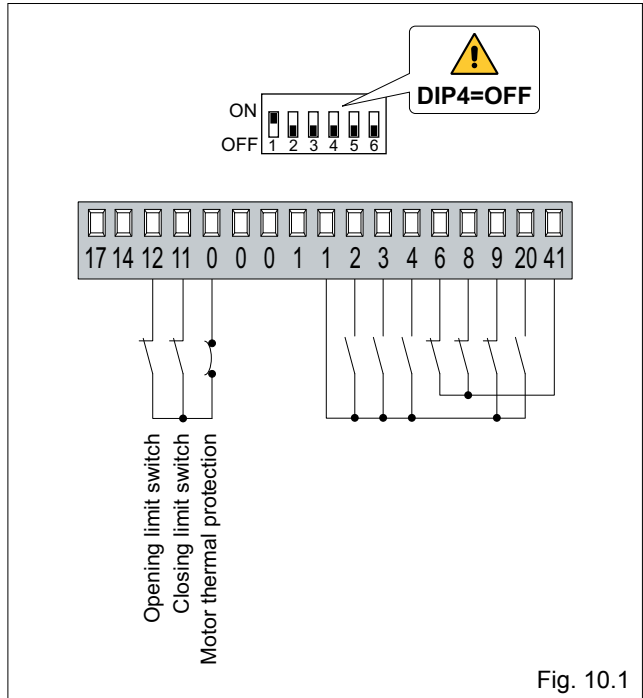

Fig. 10.1

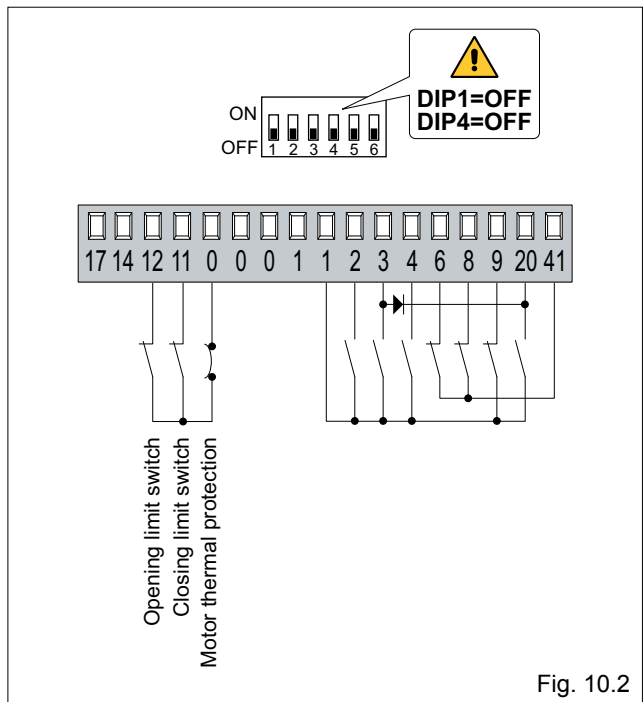
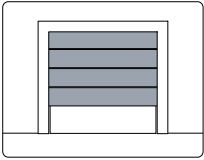

Fig. 10.2

## 11. EXAMPLE APPLICATION FOR SECTIONAL OVERHEAD DOORS



(Fig. 11.1) When the control panel is used in applications for sectional overhead doors:

- set DIP1=ON;
- set DIP2=ON;
- set DIP4=OFF;
- connect opening and closing limit switches N.C. contacts to terminals 0-11-12.

**i** **NOTE:** to use the control panel in hold-to-run mode, disconnect terminal 9.

In this case, the opening command (1-3, 1-20) and the closing command (1-4) operate only if kept pressed, if released the automation will stop. Automatic closing and radio remote controls are disabled.

(Fig. 11.2) If the SOFA1-SOFA2 self-controlled safety edge is connected on closing, make the connections indicated in the figure.

**!** **WARNING:** if the closing edge remains pressed on the floor, set SO=OFF.

**i** **NOTE:** membrane push-button panels PT3 (fig. 11.1) or PT4 (fig. 11.2) can be connected to the connector J7.

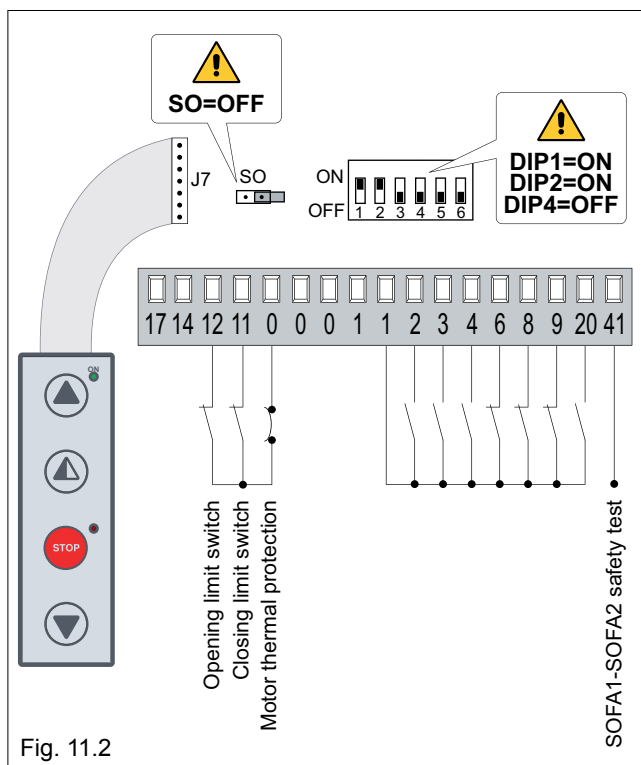
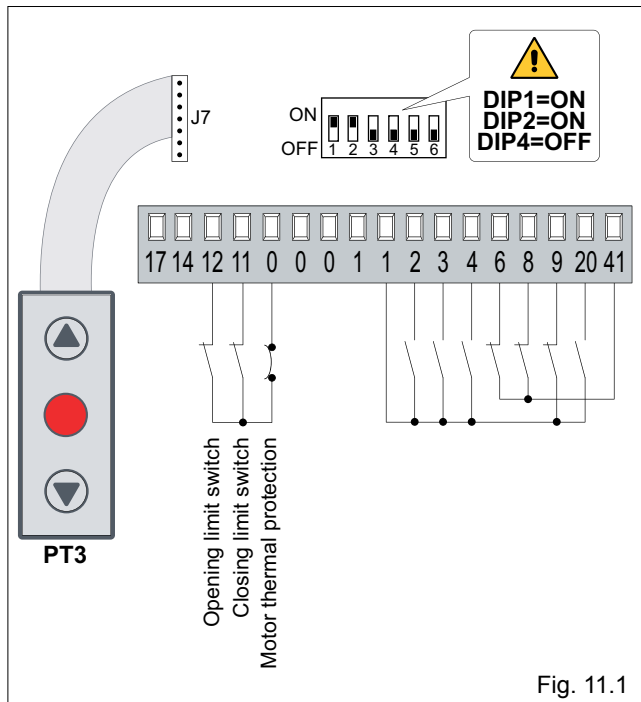

---

# ENTRE//MATIC



**Entrematic Group AB**  
Lodjursgatan 10  
SE-261 44, Landskrona  
Sweden  
[www.ditecentrematic.com](http://www.ditecentrematic.com)

