

D10 and D10 Turbo
Pocket mechanical
installation guide



CENTURION



**LIGHT-
INDUSTRIAL
SLIDING GATE
OPERATOR**

1. Introduction >>

This guide is designed specifically for installers who are familiar with the installation of standard sliding gate motors, but do not know the specifics of the **D10** and **D10 Turbo**

Always ensure that all the safety instructions described in the installation manual are adhered to during and after the installation process is completed.

2. Important Safety Instructions >>



Please do not proceed with the installation until you have read and fully understand the Safety Instructions included in your product packaging

The Safety Instructions are also available on www.centsys.com, and may also be obtained by contacting Centurion Systems on +27 860 236 887 or +27 11 699 2400

3. Icons used in this guide >>



This icon indicates tips and other information that could be useful during the installation



This icon denotes variations and other aspects that should be considered during installation



This icon indicates warning, caution or attention! Please take special note of critical aspects that **MUST** be adhered to in order to prevent injury

4. General description >>

The **D10** is a heavy duty sliding gate operator designed to open and close sliding gates. The **D10 Turbo** is perfectly suited for sites with lighter gates requiring a high number of operations per day, and can reach almost double the speed of the standard **D10**. However, the **D10 Turbo** is not recommended for gates weighing more than 240kg, as the inertia generated by heavier loads might prove detrimental to the gearbox at such high speeds. A die-cast aluminium gearbox, coupled to a powerful 24V DC motor and switch mode charger, make the **D10** the automatic choice for townhouse complexes and office parks. Gate travel limits are managed by an opto-electronic system, comprising of a gate-mounted origin magnet and an internal rotary encoder. This system yields precise and repeatable control over gate position.

5. D10/D10 Turbo identification >>

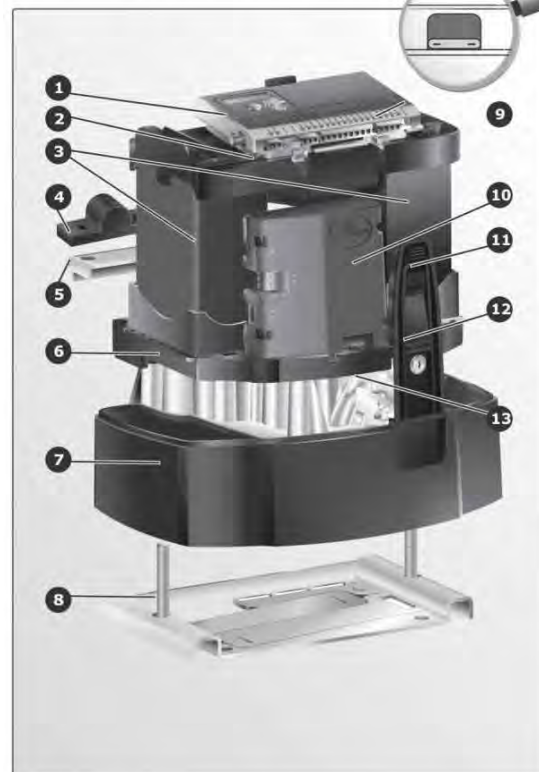

- | | |
|---------------------------------------|--|
| 1. D10/D10 Turbo controller | 8. Foundation plate |
| 2. Courtesy light fuse (3A F/B) | 9. Motor fuse (30A ATO) |
| 3. 2 x 12V 7.2Ah battery | 10. D10/D10 Turbo charger |
| 4. Gate mounted origin marker | 11. Manual release handle |
| 5. Origin marker bracket | 12. Lock cover |
| 6. Origin sensor (clip under battery) | 13. Encoder sensor (clip behind charger) |

Lower cover

6. Technical specifications >>

It is a 24V DC battery operated unit with the following limitations:

	D10	D10 Turbo
Operator push force - starting	40kgf	20kgf
Operator push force - rated	30kgf	15kgf
Gate mass - maximum	1000kg	240kg
Gate length - maximum	100m	50m
Maximum numbers of operations per day	750*☆	750*☆

* Based on a push force of less than 50% of rated ☆ With a brush replacement interval of two years

7. Preparation of site >>

General considerations for the installation

For comprehensive information, please refer to the full installation manual available for download on www.centsys.com

Install the gate operator only if:

- It will not pose a hazard to the public
- There is sufficient clearance to a roadway and/or public thoroughfares
- The installation will meet all municipal and/or local authority requirements once completed
- The gate mass, length and application is within the operator specifications
- The gate is in good working order, meaning:
 - That it moves freely
 - Does not move on its own if left in any position
 - It can be installed to have sufficient clearance between moving parts when opening and closing to reduce the risk of personal injury and entrapment
- Pushbuttons or keyswitches, when required, can be positioned so that the gate is in line of sight of the operator

Make sure the gate mass, starting - and rated-pull-force limitations are not exceeded.

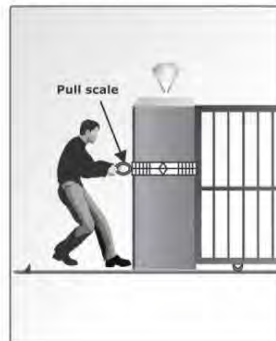

Typical anti-lift arrangements

Guide-rollers must ensure that the gate is held vertically through the entire length of the gate travel. For improved safety fit additional support posts to prevent gate from falling over if guide-rollers fail.



Ensure that the gate cannot be lifted off the motor pinion with the anti-lift bracket fitted

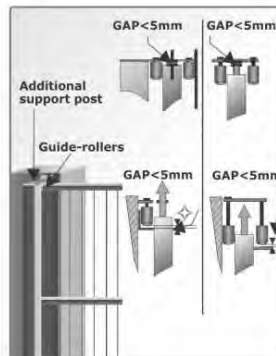

Endstops

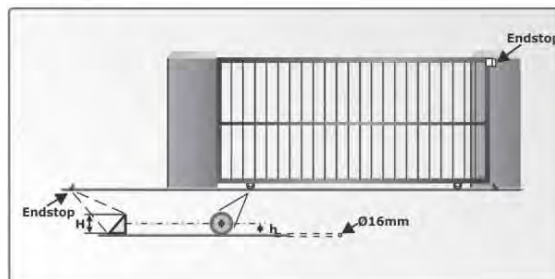

Fit endstops capable of stopping the gate at rated speed.



Make $H > h$ to ensure gate will not jump over endstop as shown above

Since the **D10 Turbo** operates at exceptionally high speeds, it is mandatory to install the following additional safety equipment in order to ensure the safest possible installation:

- Opening safety beams, which will prevent the gate from moving should anyone be in the path of the gate while opening

- Closing safety beams, which will prevent the gate from moving should anyone be in the path of the gate while closing
- Passive Sensitive Edge to help absorb the kinetic energy of the gate in the event of a collision and provide additional time for the inherent electronic anti-crushing technology of the operator to react. Must be installed on all shearing edges

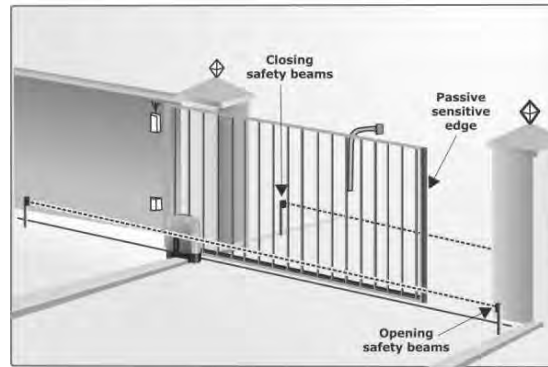

Additionally, the IRBOC feature must be invoked on the controller so that the gate will immediately reverse direction, in the event of a collision, regardless of whether it is commencing with the opening or closing cycle

8. Lubrication >>



Do not attempt to run the operator without first filling the gearbox with lubricant

In order to prevent possible leakage during shipping, the unit is shipped with no oil inside the gearbox. A bottle containing 80ml of a special synthetic oil is included with the product, and this must be introduced before operating the product.

Oil filling procedure

It is more convenient to introduce oil before bolting the unit down, as shown in the illustration below. The **D10/ D10 Turbo** does not require routine oil changes. However in the event of the unit losing oil due to stripping down or mechanical damage, the correct replacement oil is **Castrol SAF XO 75W-90 synthetic final drive lubricant**



Oil specifications

CENTURION product code:
OIL80MLXO/H
Castrol SAF-XO 75w-90 Synthetic Final Drive Lubricant



- Remove dipstick from gearbox
- Cut the tip off the nozzle which will allow for the oil to pass through the nozzle; unscrew the oil bottle cap; remove the seal from beneath the oil bottle cap; replace the oil bottle cap onto the bottle and attach the extension tube to the nozzle
- Fill the gearbox with the oil provided



9. Cabling requirements >>

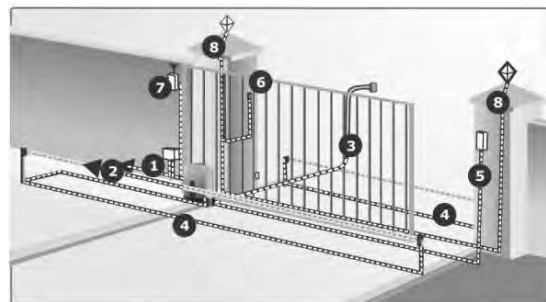

Legend

1. 220V-240V AC mains cable via double pole mains isolator switch (3 core LNE 1.5mm² SWA)* ✱

Optional wiring (all cable is multi-stranded):

2. Intercom cable from motor to dwelling (n1 + 6 core 0.5mm²)
3. Intercom cable from motor to entry panel (n2 0.5mm²)
4. **Safe Close and Safe Open:** Recommended infrared safety beams (3 core 0.5mm²)
5. Access control device (3 core 0.5mm²)

- 6. **Ped:** Optional pedestrian keyswitch (a) or keypad (b) (3 core 0.5mm²)
- 7. **Trg:** Optional external radio receiver (3 core 0.5mm²)
- 8. **Light:** Optional pillar lights (3 core LNE SWA, size according to power requirements)

n1 = number of cores required by intercom

n2 = number of cores required by intercom

- * Possibly increase cable thickness if pillar lights are installed
- ☆ Type of cable must adhere to municipal bylaws but typically SWA (steel wire armoured) cable is recommended. The armouring provides excellent screening, which gives better protection against lightning – earth one end of the screening)
- ❖ Allows for all features such as pedestrian opening, status LED, etc., to be operated from the intercom handset inside the dwelling. Number of cores and type of cable could vary depending on brand of access control system being used
- ❖ For optimum range, an external receiver can be mounted on the wall

10. Manual operation >>

Manual release operation

In the event of power failure, or product malfunction, it may be required to lock the cover in place whilst 'latching' the manual release (i.e. manual release permanently enabled). This helps prevent theft of the unit, or its components, and provides full protection from the elements

1. Manual release handle in closed position.
2. Open lock cover and insert key. Turn the key a quarter-turn, counter-clockwise to unlock.
3. Pull the manual release handle down to enable manual release.



Manual release latching

Now that manual release is enabled, you may follow the process below to lock the cover in place.

4. With the release handle lowered, insert the split pin, (supplied with the mounting hardware kit), through the hole in the gearbox as indicated.
5. Make sure that the split pin goes all the way in as shown.

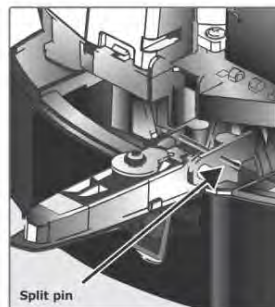
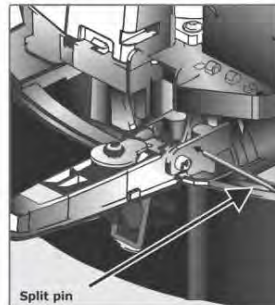

6. Raise handle and then turn key a quarter-turn clockwise to lock. Remove key and close lock.



11. D10/D10 Turbo operator installation



Ensure that all the standard considerations for a quality gate installation are adhered to as detailed in CENTURION's detailed installation manuals. These must include:

- Correct access in and out of the premises
- Endstops are mandatory and must be capable of stopping the gate at rated speed
- Guide-rollers and anti-lift brackets are correctly fitted
- The gate mass, starting- and rated-pull-force limitations are not exceeded
- The **D10/D10 Turbo** is positioned correctly and does not protrude into the driveway

Locate operator position

1. To ensure operator does not protrude into driveway, install base plate at least flush with the driveway entrance.
2. Determine a suitable position and vertical height for the operator by considering Figures A, B and C.

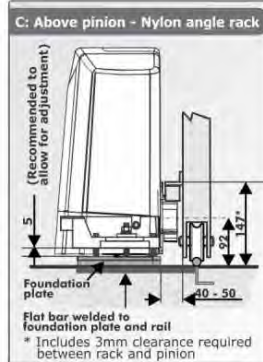
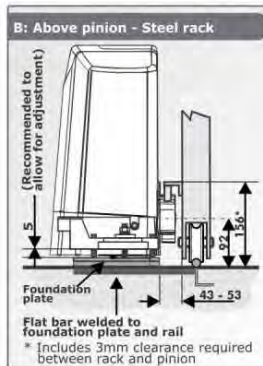
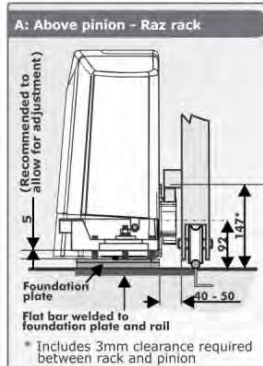

Foundation plate installation

The foundation plate can either be set into a concrete foundation, or bolted down onto an existing concrete plinth, refer to illustrations below.

Option 1:

New concrete foundation

When using a concrete foundation it is recommended that the foundation plate is welded to the rail/track of the gate using a short length of flat bar as shown in the illustration. This makes it possible to complete the whole mechanical and electrical installation without having to wait for the concrete to set. After completing the installation the concrete can be poured and the operator left in manual mode until the concrete has set.

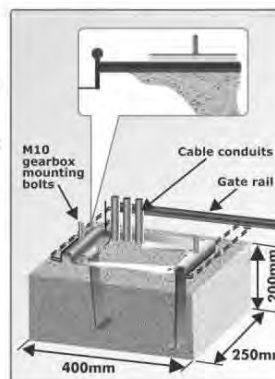

- Ensure that the M10 gearbox mounting bolts are properly tightened
- Cable conduits must be installed before pouring the concrete



Option 2:

Bolting foundation plate onto an existing concrete plinth

If bolting onto an existing concrete plinth, place the foundation plate down in the correct position and use the plate as a template for marking the rawl bolt holes.



Ensure that the M10 gearbox mounting bolts are properly tightened

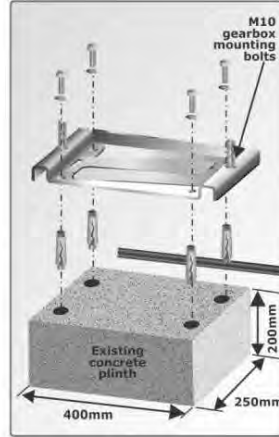

Route cables and secure foundation plate

1. Route cables as determined in Section 9: Cabling requirements.
2. The cable conduits or SWA cable glands should terminate onto the cable termination flange provided in the foundation plate, as depicted in the illustration
3. Make sure that all cables protrude at least 500mm from the cable termination flange.



If bolting the foundation plate, the left-hand concrete anchor may need to be broken off in order to clear incoming conduits

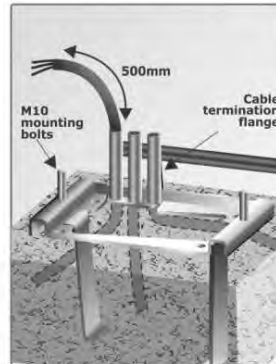

Make sure that the M10 bolts, which secure the gearbox, are in place

1. Insert M8 captive nuts for the jacking screws as shown.
2. Screw the M8 grub screw jacking screws into the captive nuts.

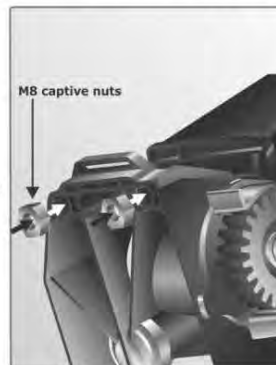

3. Adjust jacking screws to give 4-6 mm chassis foundation plate clearance.



A 4mm Allen key with "ball end" is handy



Mount the rack



The rack must be securely mounted to the side of the gate. It must be parallel with the gate rail, and there must be a 2 - 3mm gap between the teeth of the pinion and the rack, along the entire travel of the gate

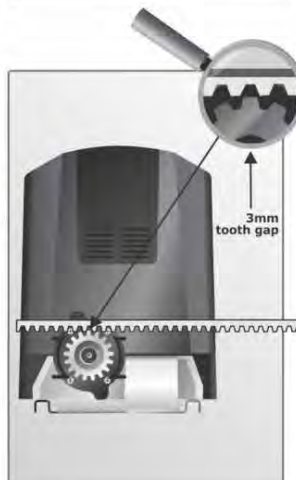

Steel rack

1. Fix rack using the steel angle brackets provided.
2. Brackets must be spaced no more than 300mm apart.
3. When joining different lengths of steel rack, a simple way of ensuring correct pitch spacing, is to clamp a small off-cut between the two pieces.

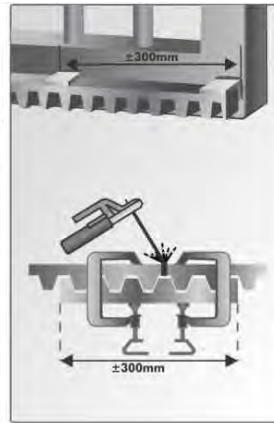

RAZ rack

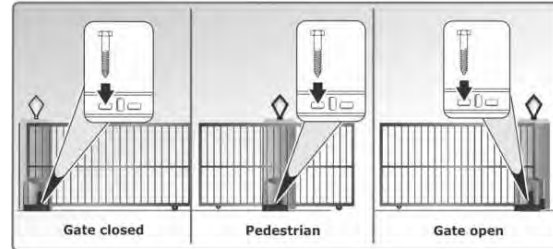

1. Use at least three TEK screws per half metre section of rack.



Fit additional fixing screw through the horizontal slots to secure the rack to the gate directly above the pinion when the gate is in the closed, pedestrian and open positions

Mounting the origin marker

1. Close the gate completely.
2. Mount the origin marker to the rack a minimum of 500mm from the origin sensor.

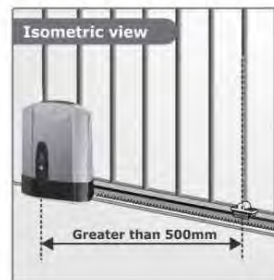

Steel rack

3. For steel rack mount the origin marker onto the rack using the bracket provided.
4. Weld the bracket to the rack.
5. Bolt the origin marker onto the bracket using the fasteners provided.

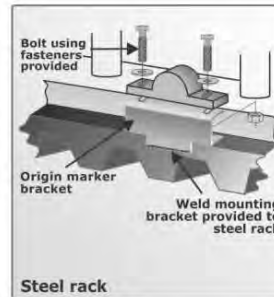

Steel rack

RAZ rack

6. With RAZ rack the origin marker mounts directly on top of the rack without a bracket.
7. Drill mounting holes directly into the rack and bolt into position.
8. File away the front lip of the rack if you need to move the origin marker closer to the operator as the gate slides past.

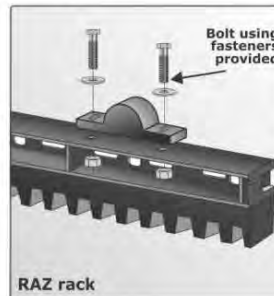

RAZ rack

Nylon angle rack

9. With nylon angle rack it is necessary to use the bracket provided.
10. It is preferable to use self-tapping fasteners to secure the bracket into the side of the nylon rack as shown.
11. Make a small tack weld to secure the back of the bracket onto the angle iron section of the rack.
12. Bolt the origin marker onto the bracket using the fasteners provided.

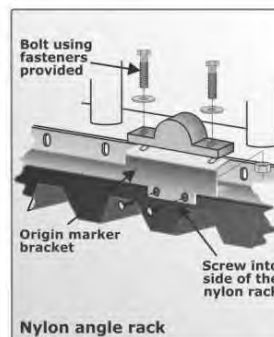

Nylon angle rack

Mounting the origin marker (continued)

13. Manually slide the gate OPEN until the origin marker is in line with the origin sensor.



14. Ensure distance between face of marker and front face of sensor is between 13 and 20mm.



Take care with the orientation of the arrow on the origin marker. This arrow must face the operator

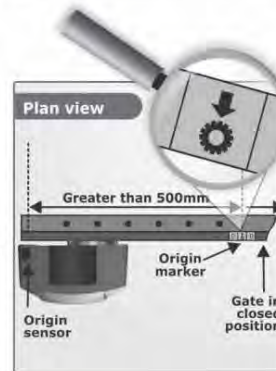

15. Adjust distance by sliding the origin marker along the slotted mounting holes until the specified distance is achieved.



For best results keep gap between marker and sensor as small as possible

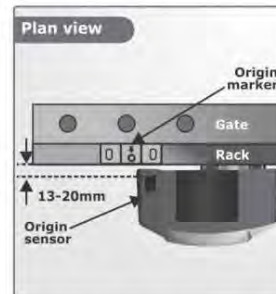

- It is possible to make the distance between the marker and the sensor much greater than 500mm. However, if using the pedestrian opening facility, although the position of the marker will not affect the width of the pedestrian opening, it is preferable to have the marker mounted inside of the pedestrian opening point

Apply warning decal/signage

Apply the supplied Warning! decals/signage to the gate



12. Basic maintenance >>

CENTURION operators are designed to be maintenance-free. However, there are some basic checks that should be carried out regularly, (every six months). These checks will increase the long term reliability of the system and prevent erratic operation of your gate.



Isolate mains supply as well as disconnecting the battery before cleaning or working on the equipment.

General

- Keep the track clear of stones, dirt and obstructions
- Ensure that all rollers run freely
- Put the operator into Manual Mode and check that the gate runs freely on its rail and does not catch or foul against the walls or pillars
- Ensure that the gate wheels and guide-rollers are rotating freely and are not worn. In high-volume applications it will be necessary to replace these components regularly
- Ensure that the rack is properly secured to the gate and that it does not press down onto the operator pinion at any point along its travel
- Keep shrubs and vegetation clear of the motor and rack
- Check that the key still operates the camlock - spray with lubrication if necessary
- Keep the inside of the motor housing clear of insects and dust

Battery

CENTURION operators, which are fitted with maintenance-free lead acid batteries, should provide at least three years of normal service life.

For sites utilising an external large capacity (+/-35Ah) low maintenance battery, ensure that the level of liquid (electrolyte level) is correct.

In all instances check for corrosion of the battery terminals. Clean and apply copper based grease as necessary.

Charger

The **D10** and **D10 Turbo** operators have chargers separate to the main controller. In the case of product malfunction, the charger fuse should be checked, but only by a qualified electrician. Always isolate the mains supply to the operator before attempting to remove and check the fuse.

Check the "Mains Present" icon on the main diagnostic screen or switch to the battery charger diagnostic screen and check the charger voltage – right hand value. This should indicate, 27.6V for the **D10** and **D10 Turbo**. Each charger has a red light (LED) to indicate mains supply.

Gearbox Oil Level

Check the oil level as described in section 8 of this document or refer to the online manuals on our website, (www.centsys.com). Alternatively, please contact your CENTURION installer for assistance.

13. Installation handover >>

Once the installation has been successfully completed and tested, it is important for the installer to explain the operation and safety requirements of the system.

NEVER ASSUME THE USER KNOWS HOW TO SAFELY OPERATE AN AUTOMATED GATE!

Even if the user has used one before, it does not mean he knows how to SAFELY operate it. Make sure that the user fully understands the following safety requirements before finally handing over the site.

The following needs to be understood by the user:

- How to operate the manual release mechanism.
(Show them how by demonstration)
- How the obstruction detection and all other safety features work.
(Show them how by demonstration)
- All the features and benefits of the operator, i.e. safety beams, ChronoGuard, etc.
- **All the safety considerations associated with operating an automated gate. The user should be able to pass this knowledge on to all other users of the automated system and must be made aware of this responsibility.**



- Do not activate the gate operator unless you can see it and can determine that its area of travel is clear of people, pets, or other obstructions
- **NO ONE MAY CROSS THE PATH OF A MOVING GATE.** Always keep people and objects away from the gate and its area of travel
- **NEVER LET CHILDREN OPERATE OR PLAY WITH THE GATE CONTROLS,** and do not allow children or pets near the gate area
- Be careful with moving parts and avoid close proximity to areas where fingers or hands could be pinched
- Secure all easily accessed gate operator controls in order to prevent unauthorized use of the gate
- Keep the automated gate system properly maintained, and ensure that all working areas are free of debris and other objects that could affect the gate operation and safety
- On a monthly basis, check the obstruction detection system and safety devices for correct operation
- All repair and service work to this product must be done by a suitably qualified person
- This product was designed and built strictly for the use indicated in this documentation. Any other use, not expressly indicated here, could compromise the good condition/operation of the product and/or be a source of danger!

CENTURION SYSTEMS (Pty) Ltd. does not accept any liability caused by improper use, of the product, or for use other than that for which the automated system was designed.

Ensure that the customer is in possession of the User Guide and that you have completed the installation details in the back of the User Guide.



Sharecall 0860-CENTURION (0860 236 887)
Head Office: +27 11 699 2400

Sharecall Technical Support 0861 003 123 or
+27 11 699 2481
from 07h00 to 18h00 (GMT+2)

(Sharecall numbers applicable when dialed from within South Africa only)



0.07.A.0047_22072013

www.centsys.com