

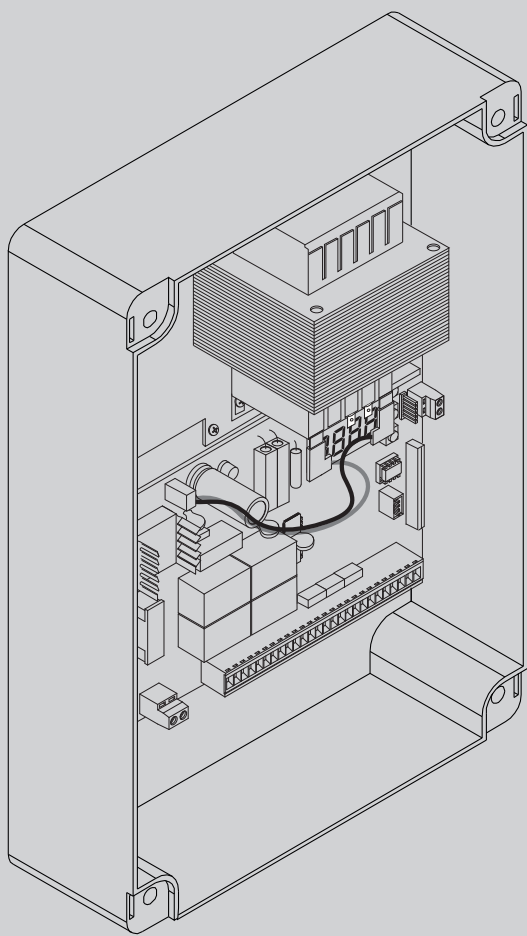

Ultra

D814123 0AA00_01 13-12-19

CONTROL PANEL



INSTALLATION MANUAL

THALIA

BFT



AZIENDA CON
SISTEMA DI GESTIONE
CERTIFICATO DA DNV GL
= ISO 9001 =
= ISO 14001 =

QUICK INSTALLATION

D814123 0AA00_01

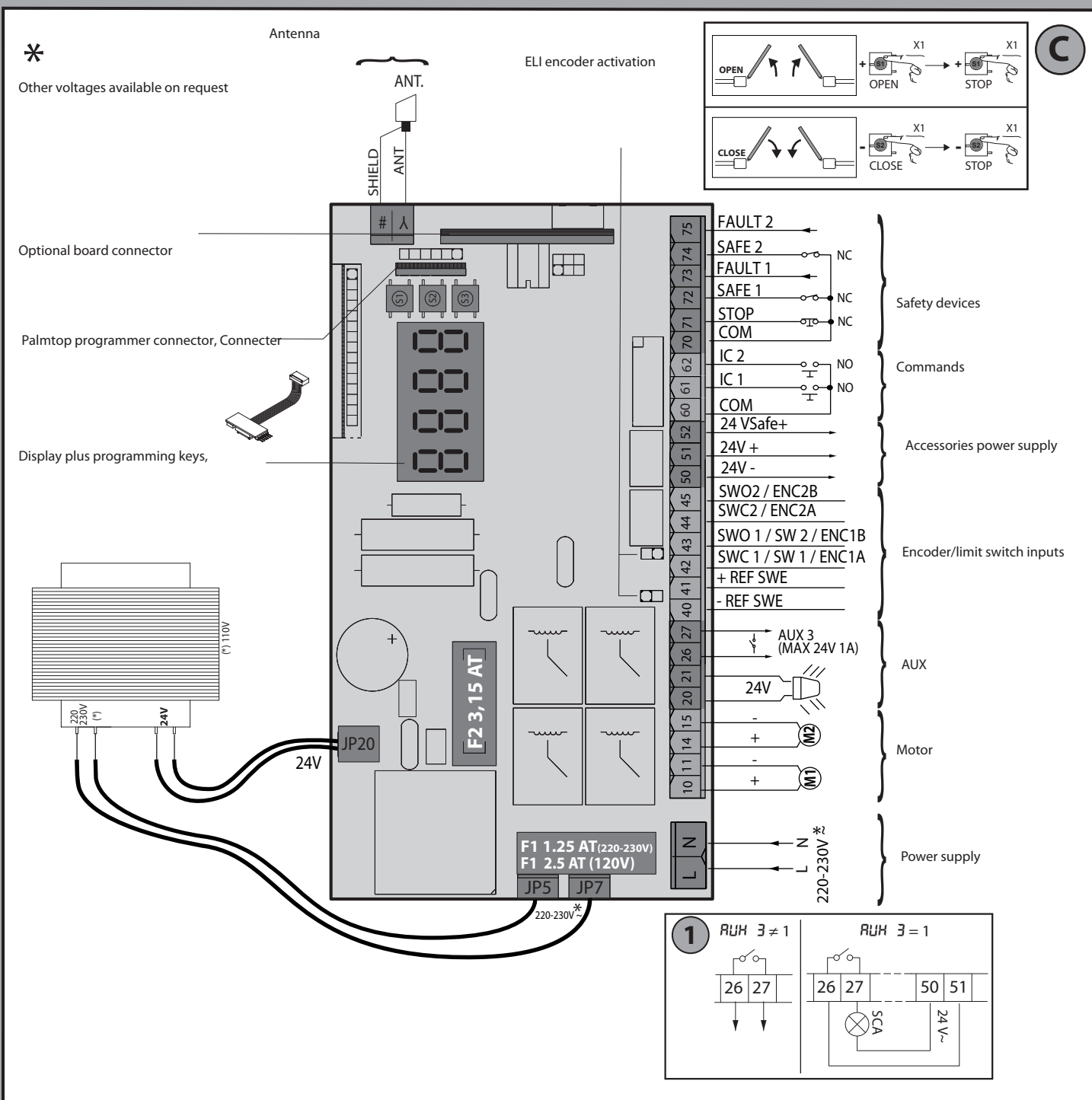
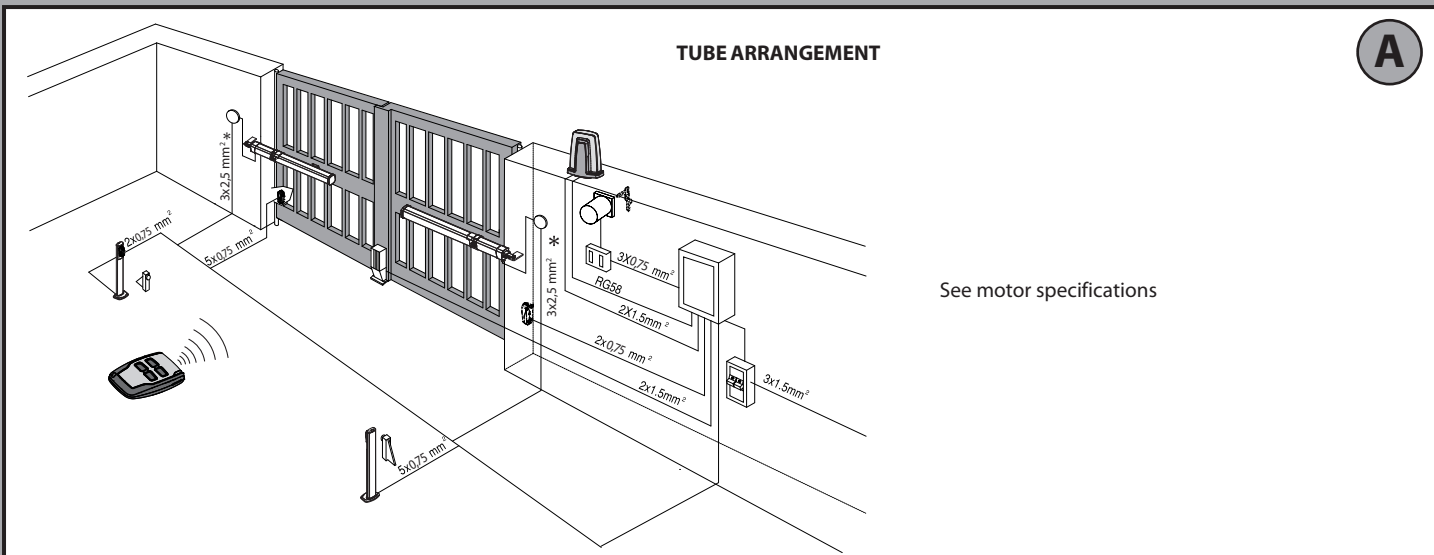

D1

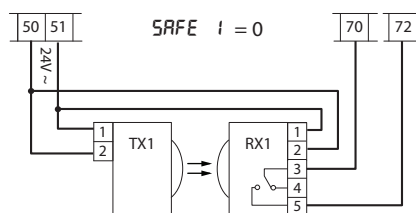

Photocells not checked (Check every 6 months)

D2

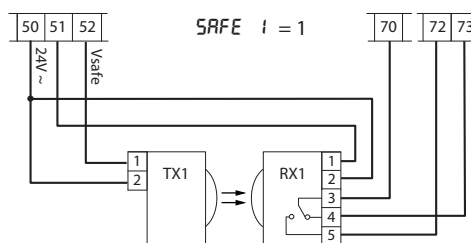

Photocell checked

ENGLISH

IT IS NECESSARY TO FOLLOW THIS SEQUENCE OF ADJUSTMENTS:

- 1 - Adjusting the limit switches
- 2 - Autoset
- 3 - Programming remote controls
- 4 - Setting of parameters/logic, where necessary

After each adjustment of the end stop position a new autoset is required.
After each modification of the motor type, a new autoset must be carried out

If the simplified menu is used:

- In GIUNO ULTRA BT A 20 - GIUNO ULTRA BT A 50 - E5 BT A18 - E5 BT A12 motors: phase 1 (end stop adjustment) is included in the simplified menu.
- In other motors: phase 1 (end stop adjustment) must be carried out before activating the simplified menu

ELI 250 BT

ε ιΡο ΡοτορΕ - εΥΡΕ dE ΡοτΕυΡ - ΡοτορΕντΥΡ - Ροτορ εΥΡΕ - ε ιΡο Ροτορ: 1

E

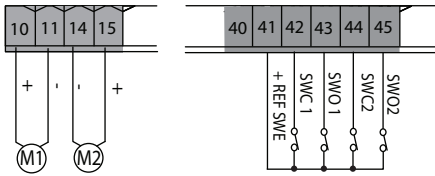

ELI 250 BT	
Maximum power	180W
Maximum cycle	continuous cycle

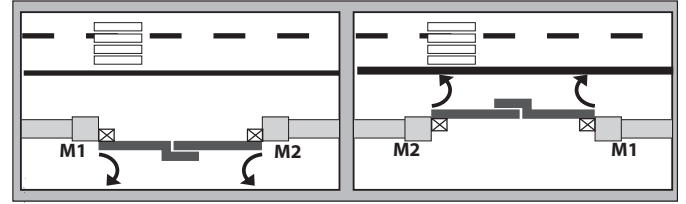
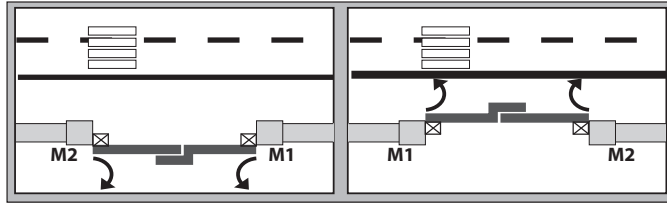

open in other direct.

= 0 (int)

open in other direct.

= 1 (EHL)

change mot

= 0

change mot

= 0

PHOBOS N BT

ε ιΡο ΡοτορΕ - εΥΡΕ dE ΡοτΕυΡ - ΡοτορΕντΥΡ - Ροτορ εΥΡΕ - ε ιΡο Ροτορ: 2

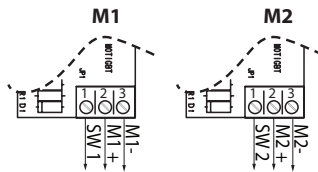
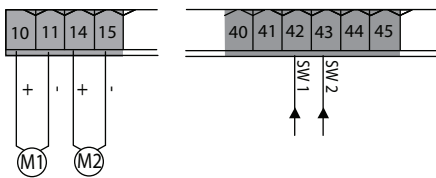

PHOBOS N BT	
Maximum power n	40W
Cycle maximum	S3 13s-1-13s-1 x30 pause

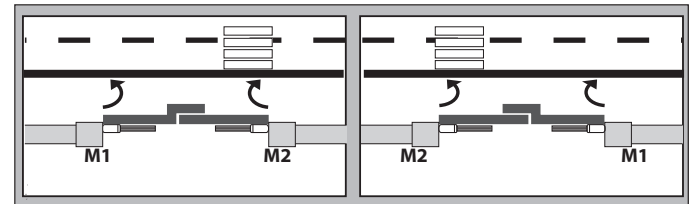
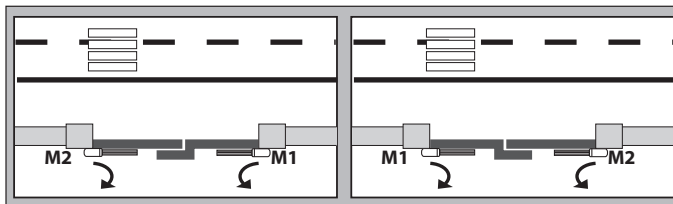

open in other direct.

= 0 (int)

open in other direct.

= 1 (EHL)

change mot = 0

change mot = 0

IGEA BT

ε ιΡο ΡοτορΕ - εΥΡΕ dE ΡοτΕυΡ - ΡοτορΕντΥΡ - Ροτορ εΥΡΕ - ε ιΡο Ροτορ: 3

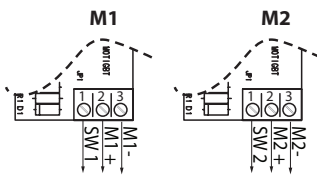
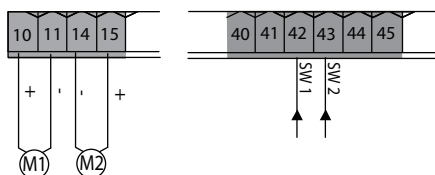

IGEA BT	
Maximum power	70W
Maximum cycle	continuous cycle

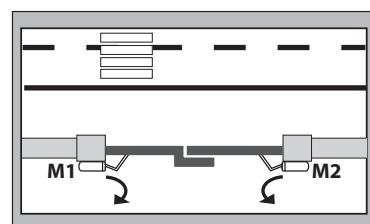
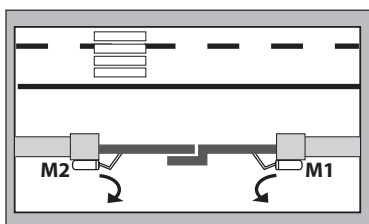

open in other direct.

= 0 (int)

open in other direct.

= 1 (EHL)

change mot

= 0

change mot

= 0

SUB BT тип мотор - тип де мотор - мотор тип - мотор тип - тип мотор: 6

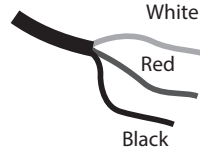
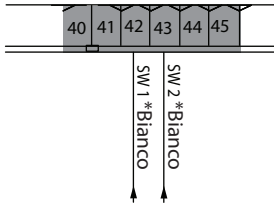
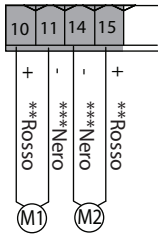

SUB BT	
Maximum power	90W
Maximum cycle	S3 17s-1-17s-1 x21 pause 90 min.
LEAF MAX	400 kg
	2 m
TYPE OF USE - SEMI-INTENSIVE	Semi-intensive

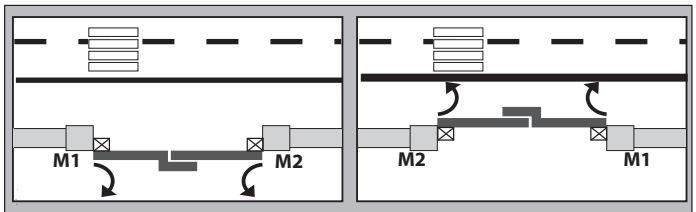
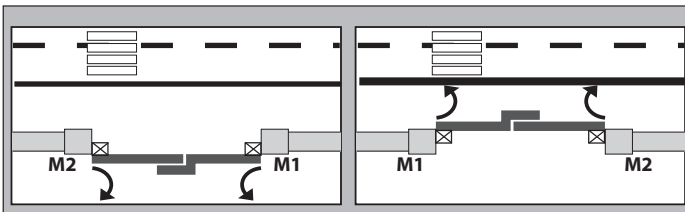

open in other direct.

= 0 (int)

open in other direct.

= 1 (EHL)

change mot

= 0

change mot

= 0

PHOBOS BT A / KUSTOS BT A тип мотор - тип де мотор - мотор тип - мотор тип - тип мотор: 7

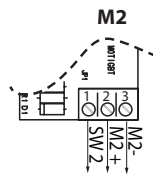
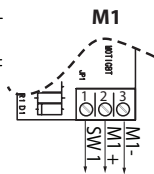
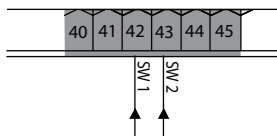
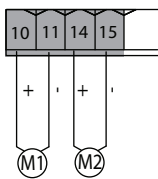

	PHOBOS BT A	KUSTOS BT A
Maximum power -	40W	40W
Maximum cycle	S3 13s-1-13s-1 x30 pause 90min.	S3 13s-1-13s-1 x30 pause 90min.

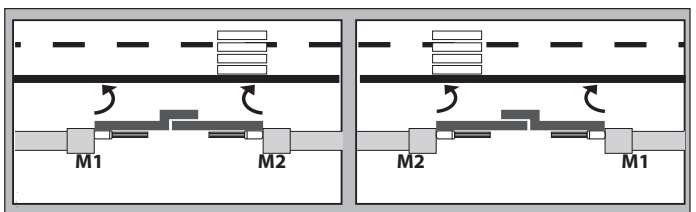
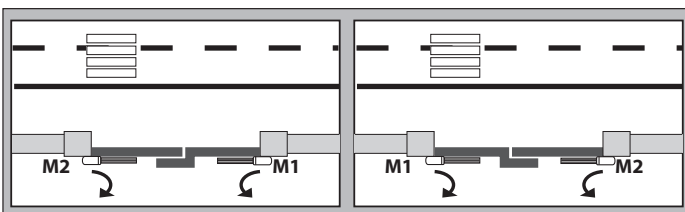

open in other direct.

= 0 (int)

open in other direct.

= 1 (EHL)

change mot

= 0

change mot

= 0

GIUNO ULTRA тип По Потер - type de PotEur - PotarEntYP - Potar tYPE - тип Потар: 8

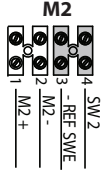
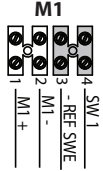
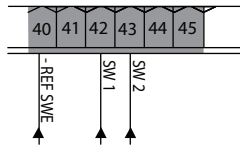
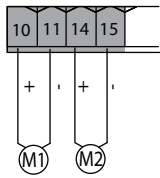

rEG. Fc - LSG AdJ - rEGLFc - EndSchE inSt

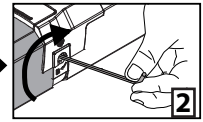
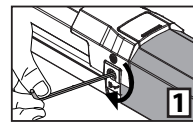

	GIUNO ULTRA BT A 20	GIUNO ULTRA BT A 50
Maximum power	90W	90W
Maximum cycle	S3 10s-5-14s-5 x40 pausa - pause - pause pause - pausa - pause 90 min.	S3 10s-5-14s-5 x40 pausa - pause - pause pause - pausa - pauze 90 min.
LEAF MAX.	150 kg	150 - 400 kg
	2 m	5 - 2 m
TYPE OF USE - SEMI-INTENSIVE	Semi-intensive	

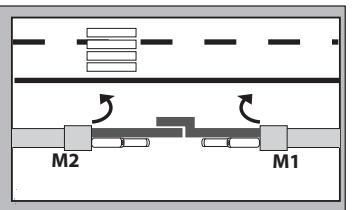
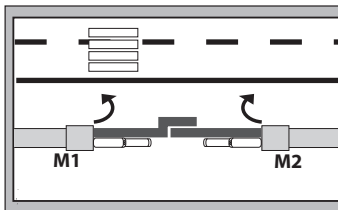
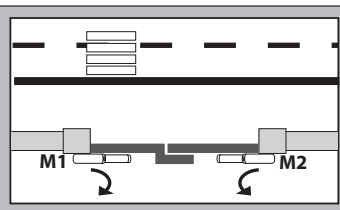
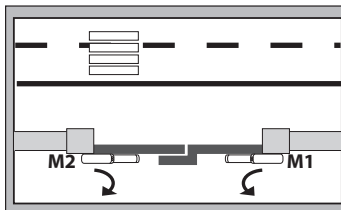

open in other direct.

= 0 (Int)

open in other direct.

= 1 (Eht)

change mot

= 0

change mot

= 0

ATTENTION: with actuators with integrated locks, the permanently active slowdown to a value higher than 5 is mandatory.





E5 BT A18 *ε ι Ρο Μοτορ Ε - ε ΤΥΡΕ dE ΡοτΕUρ - Ροτορ ΕνεΤΥΡ - Ροτορ ε ΤΥΡΕ - ε ι Ρο Μοτορ:* **11**

E5 BT A12 *ε ι Ρο Μοτορ Ε - ε ΤΥΡΕ dE ΡοτΕUρ - Ροτορ ΕνεΤΥΡ - Ροτορ ε ΤΥΡΕ - ε ι Ρο Μοτορ:* **12**

E

D814123 0AA00_01

Select the correct motor model

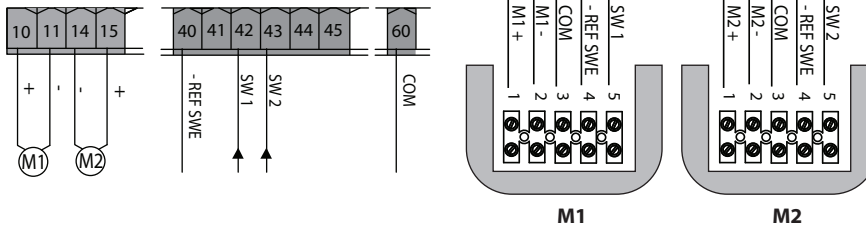

	E5 BT A18	E5 BT A12
Maximum power	40W	40W
Maximum cycle	20 cycles/h	100 cycles/h
LEAF MAX	see the motor's manual	see the table below
Maximum cable length	30m	30m

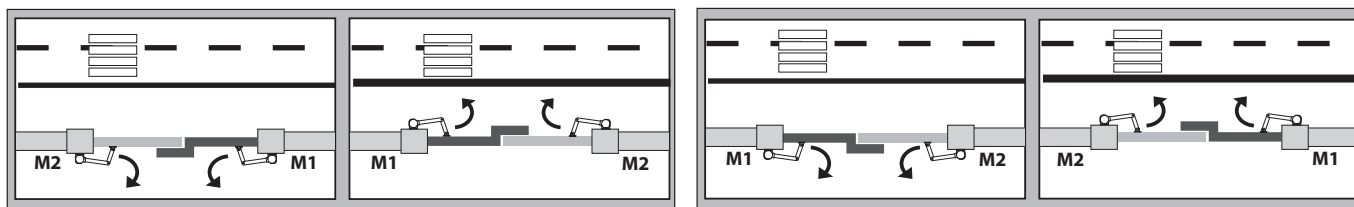

open in other direct.

= 0 (int)

open in other direct.

= 1 (EHT)

change mot

= 0

change mot

= 0

E5 BT A12

ON pedestrian gates, adjust the speed so as to limit the energy of the leaf within a maximum value of 1.69 Joule (as required by the EN16005 regulation). Use the table to determine the minimum closing times between 90° and 10°.

Leaf width (mm)	Leaf weight (kg)				
	50	60	70	80	90
750 mm	3,0 s	3,0 s	3,0 s	3,0 s	3,5 s
850 mm	3,0 s	3,0 s	3,5 s	3,5 s	4,0 s
1000 mm	3,5 s	3,5 s	4,0 s	4,0 s	4,5 s
1200 mm	4,0 s	4,5 s	4,5 s	5,0 s	5,5 s

The approaching phase (from 10° to the limit switch position) must take place in at least 1.5 s.

Example: if the leaf weighs 80 kg and has a width of 1000 mm, adjust the manoeuvre speed from 90° and 10° in at least 4.0 s.

For intermediate values, use the higher value: if the leaf weighs 75 kg consider a value of 80 kg, if its width is 1100 mm use a value of 1200 mm.

IMPORTANT: Low-energy operation is not considered a proper safety measure if the leaf is used by elderly, invalid, disabled people and children. In this case, provide additional safety measures, according to the provisions of the legislation in force.

ELI BT A 40 LS *ε ΙΡα Ποτορε - εΤΥΡΕ δΕ ΝοτεΥρ - ΠοτορεντεΥΡ - Ποτορε εΤΥΡΕ - ε ΙΡα Ποτορε:*

13

E

with limit stop

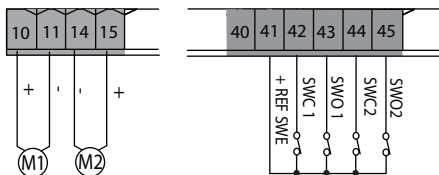

ELI BT A 40 LS	
Maximum power	180W
Maximum cycle	continuous cycle

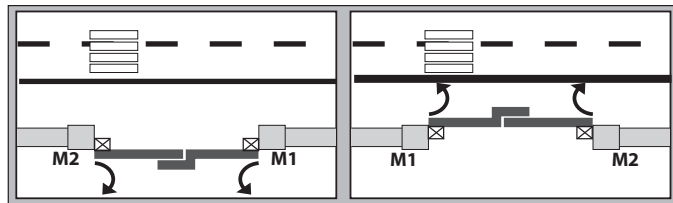

open in other direct.

= 0 (int)

change mot

= 0

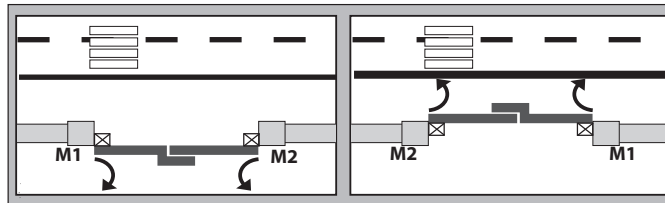

open in other direct.

= 1 (EHL)

change mot

= 0

ELI BT A 35 LS *ε ΙΡα Ποτορε - εΤΥΡΕ δΕ ΝοτεΥρ - ΠοτορεντεΥΡ - Ποτορε εΤΥΡΕ - ε ΙΡα Ποτορε:*

14

with limit stop

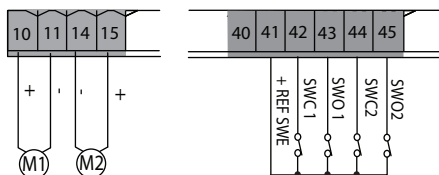

ELI BT A 35 LS	
Maximum power	40W
Maximum cycle	40 cycles/h

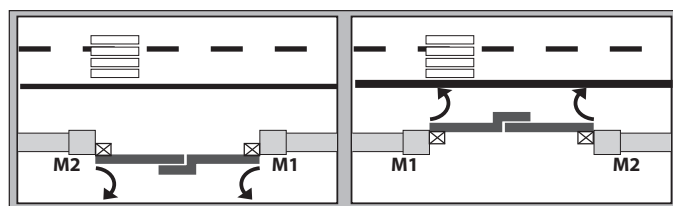

open in other direct.

= 0 (int)

change mot

= 0

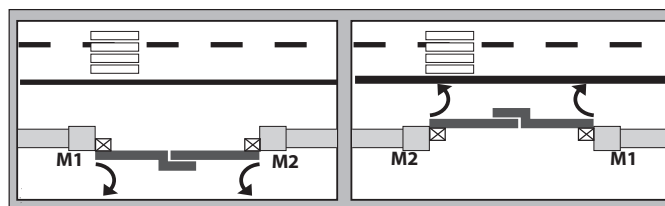

open in other direct.

= 1 (EHL)

change mot

= 0

ELI BT A 40 *ε ΙΡα Ποτορε - εΤΥΡΕ δΕ ΝοτεΥρ - ΠοτορεντεΥΡ - Ποτορε εΤΥΡΕ - ε ΙΡα Ποτορε:*

15

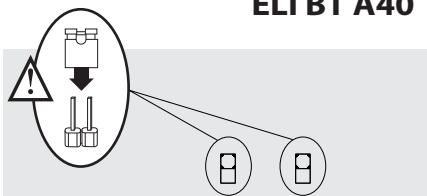

*White **Brown ***Green

ELI BT A 40	
Maximum power	180W
Maximum cycle	continuous cycle

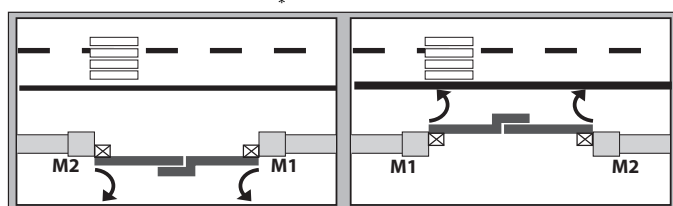

open in other direct.

= 0 (int)

change mot

= 0

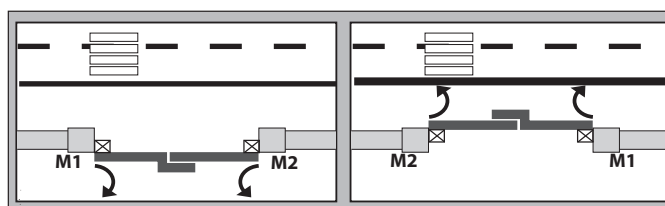

open in other direct.

= 1 (EHL)

change mot

= 0

ELI BT A35

тип двигателя - тип двигателя - двигатель - тип двигателя - тип двигателя

16

E

D814123 0AA00_01

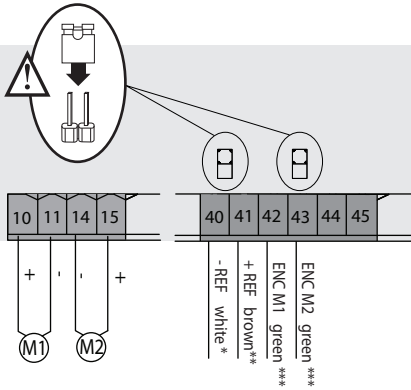

*White **Brown ***Green

ELI BT A35	
Maximum power	40W
Maximum cycle	40 cycles/h

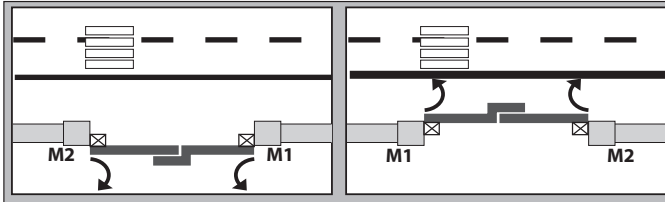

open in other direct.

change mot

= 0 (int)
= 0

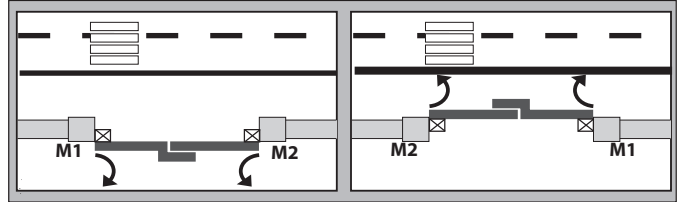

open in other direct.
i

change mot

= 1 (EHL)
= 0

SIMPLIFIED MENU

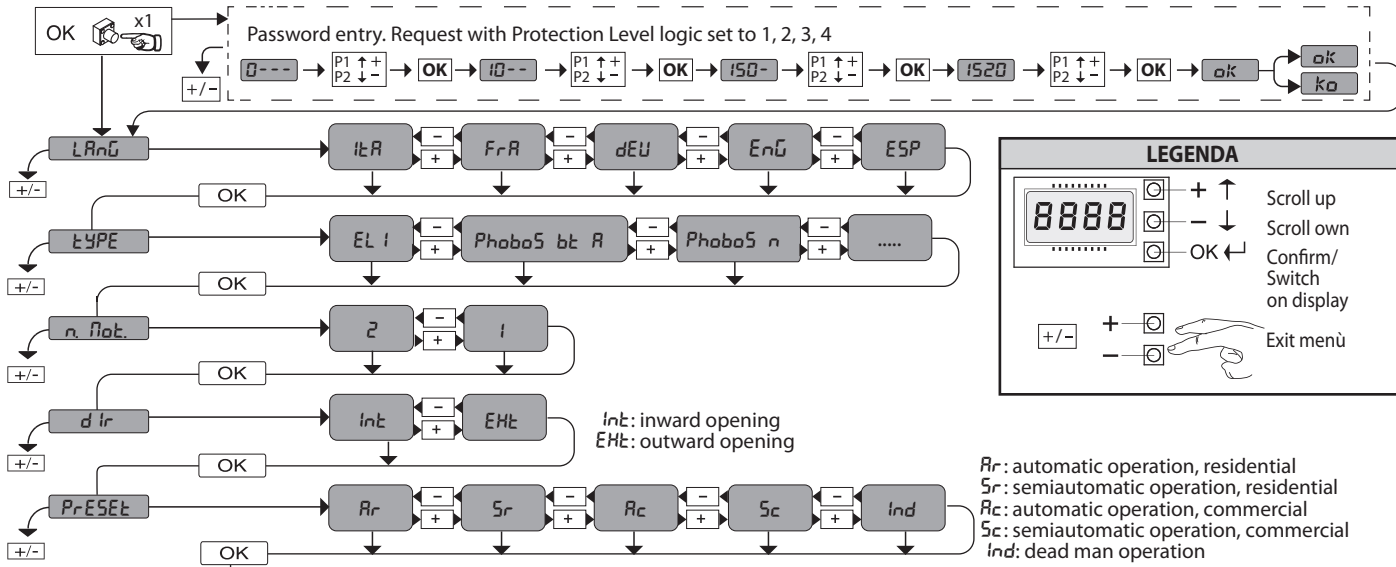

LEGENDA

+ ↑ Scroll up
 - ↓ Scroll own
 OK ↵ Confirm/ Switch on display
 +/- Exit menu

PRESET	DEFAULT	Rr	Sr	Rc	Sc	Ind
PARAMETERS						
LOGIC						
TCA	0	1	0	1	0	0
Step-by-step movement	0	1	0	1	0	0
Pre-alarm	0	0	0	1	1	0
Deadman	0	0	0	0	0	1
Block pulses during opening	0	0	0	1	1	0

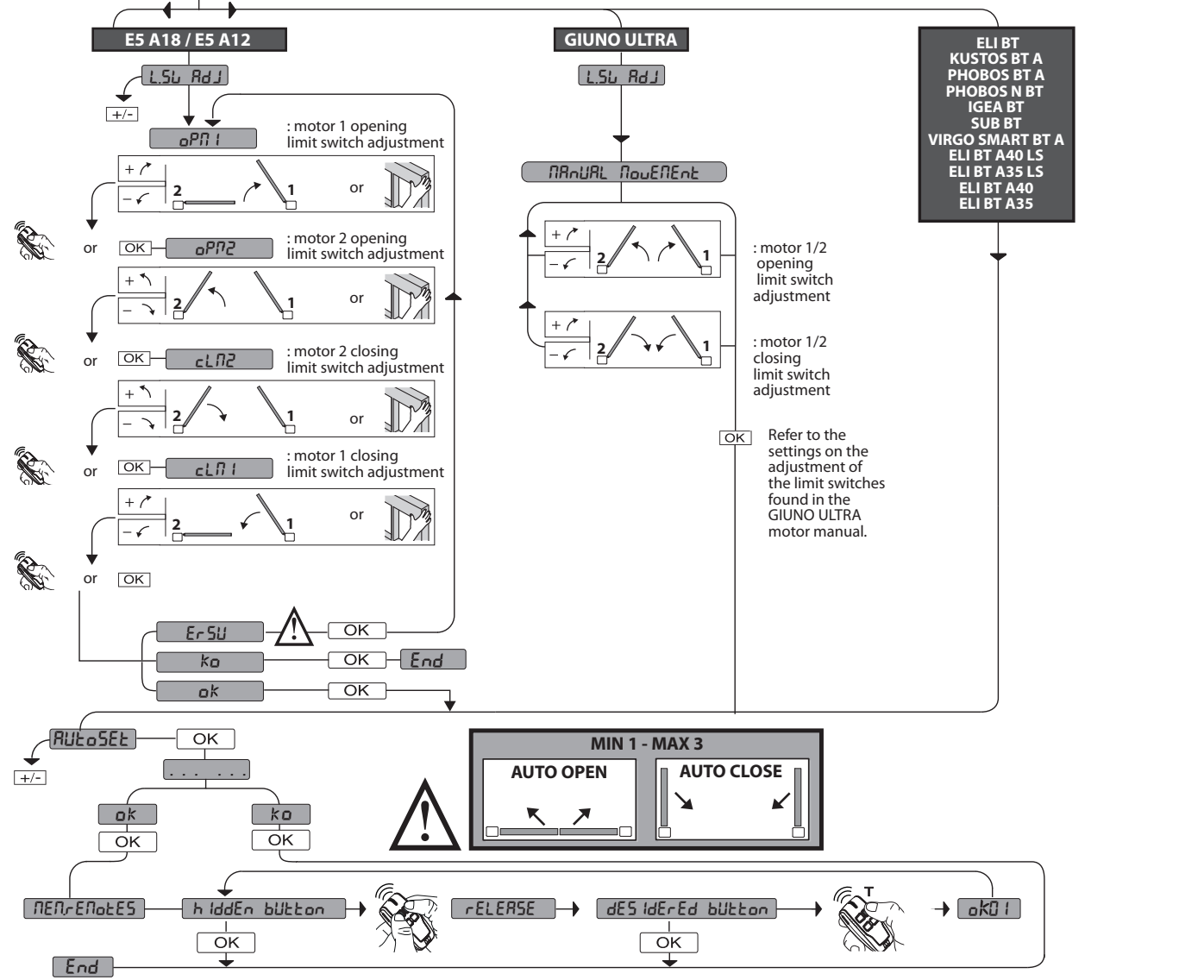

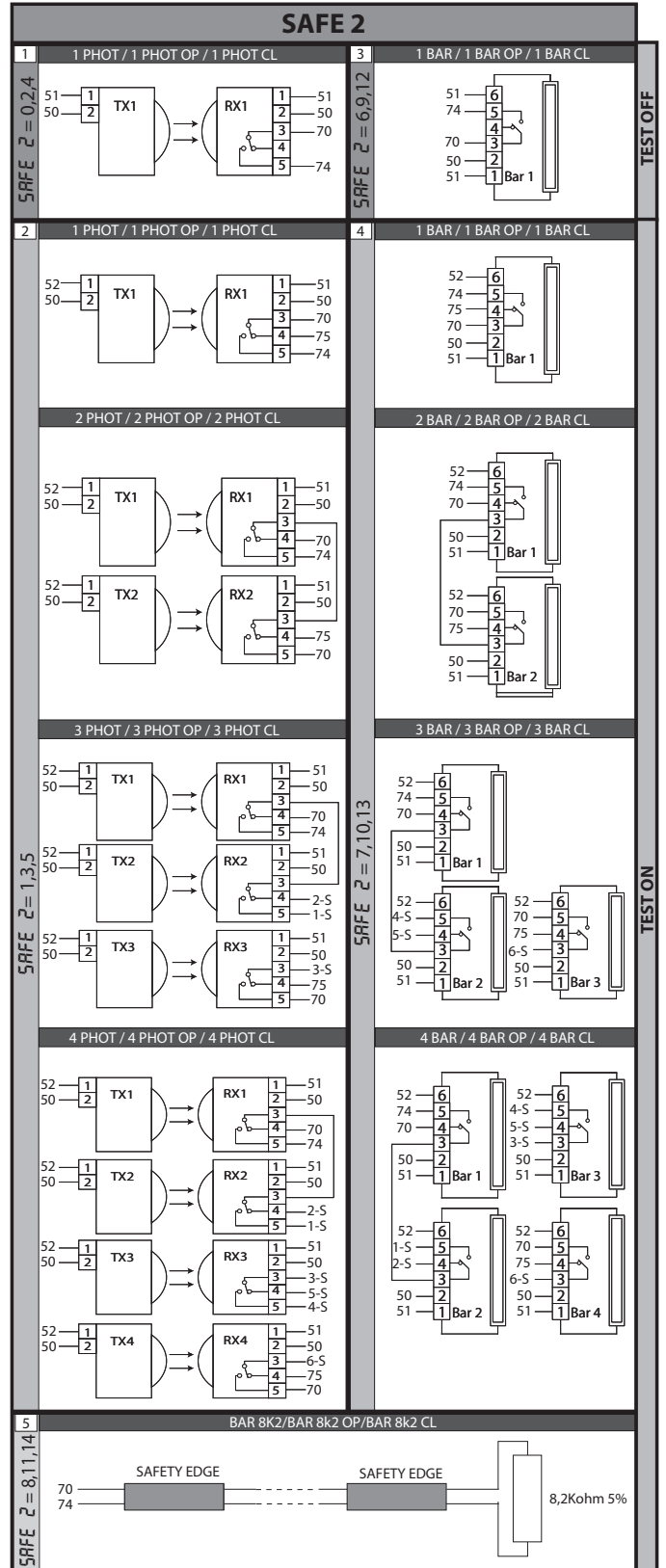
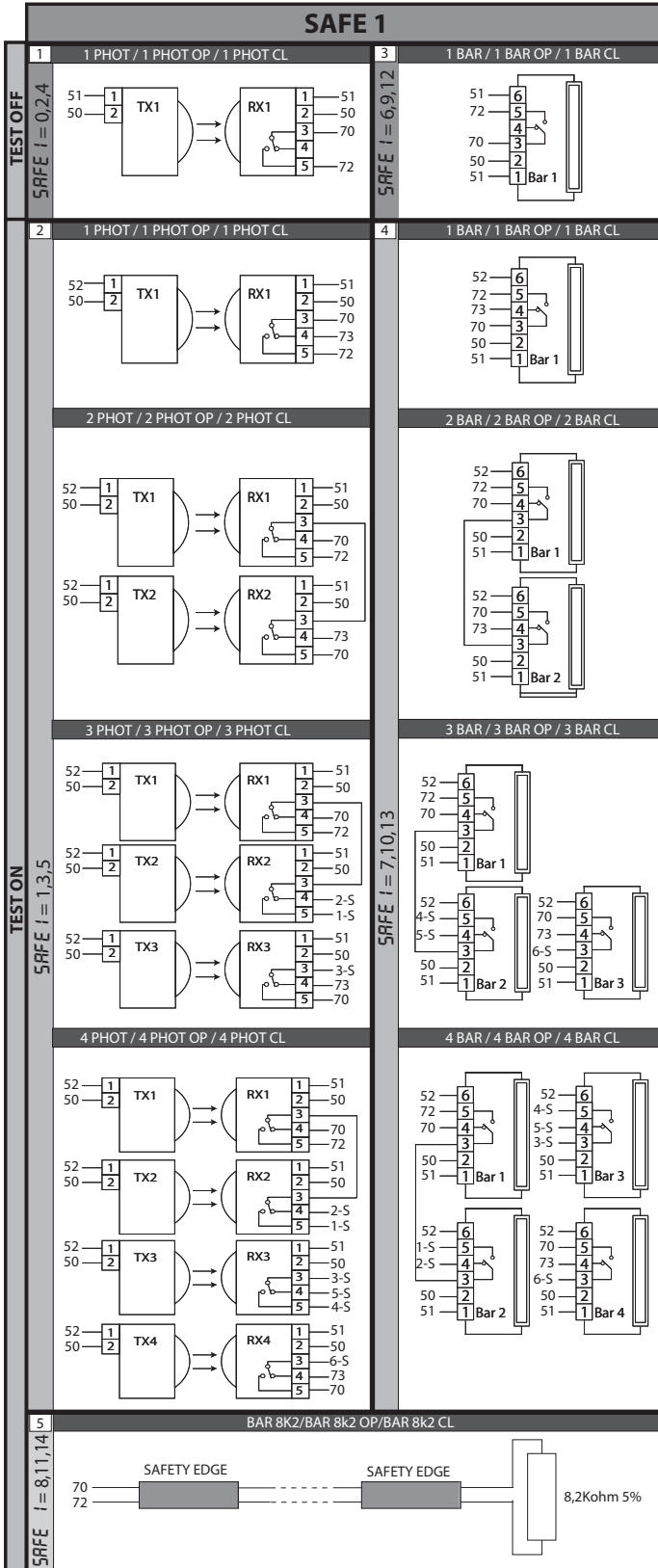
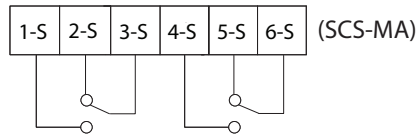
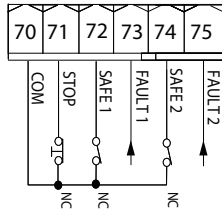
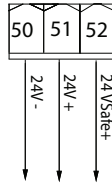

Numero massimo di dispositivi verificati: 6 (ma non più di 4 per tipo),
 Maximum number of tested devices: 6 (but no more than 4 per type),
 Nombre maximum dispositif vérifiés: 6 (mais pas plus de 4 par type),
 Max. Anzahl der überprüften Geräte: 6 (jedoch nicht mehr als 4 je Typ),
 Número máximo dispositivos comprobados: 6 (pero no más de 4 por tipo),
 Maximumaantal "trusted devices": 6 (maar niet meer dan 4 per type)

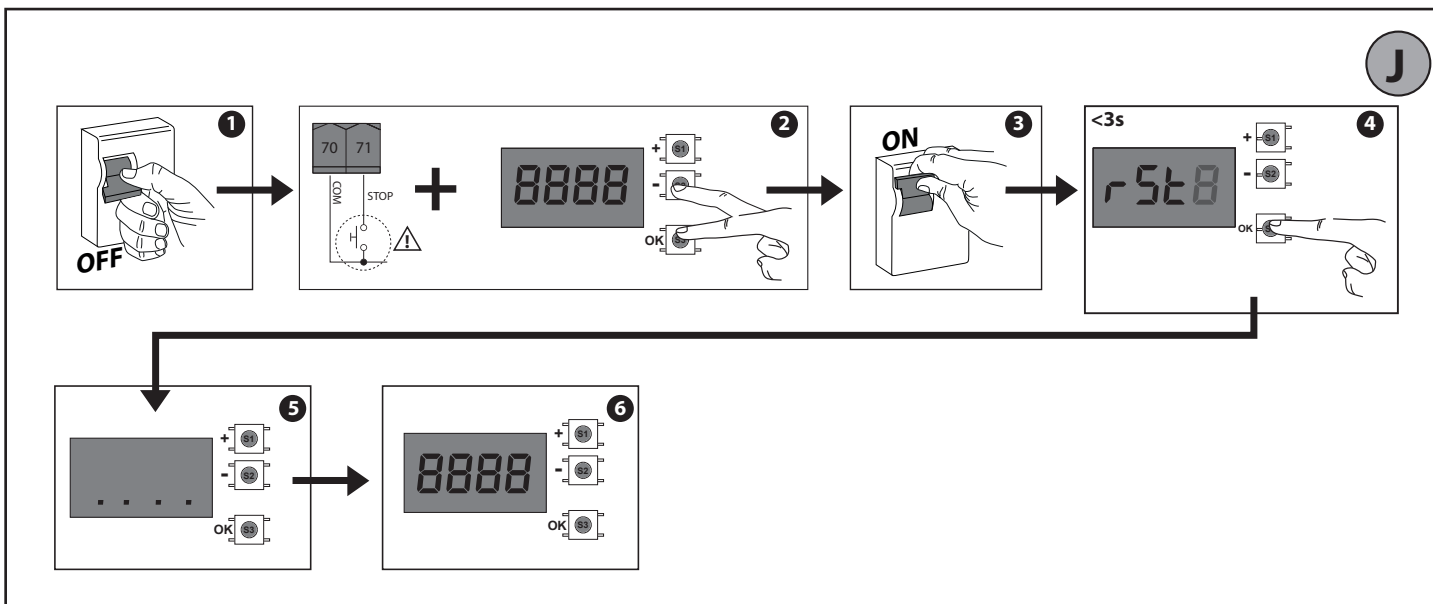
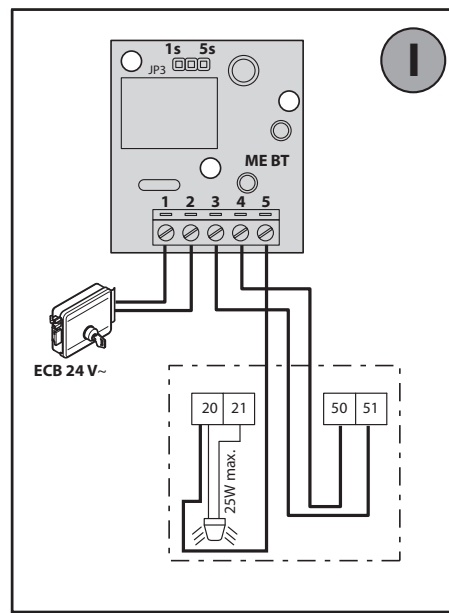
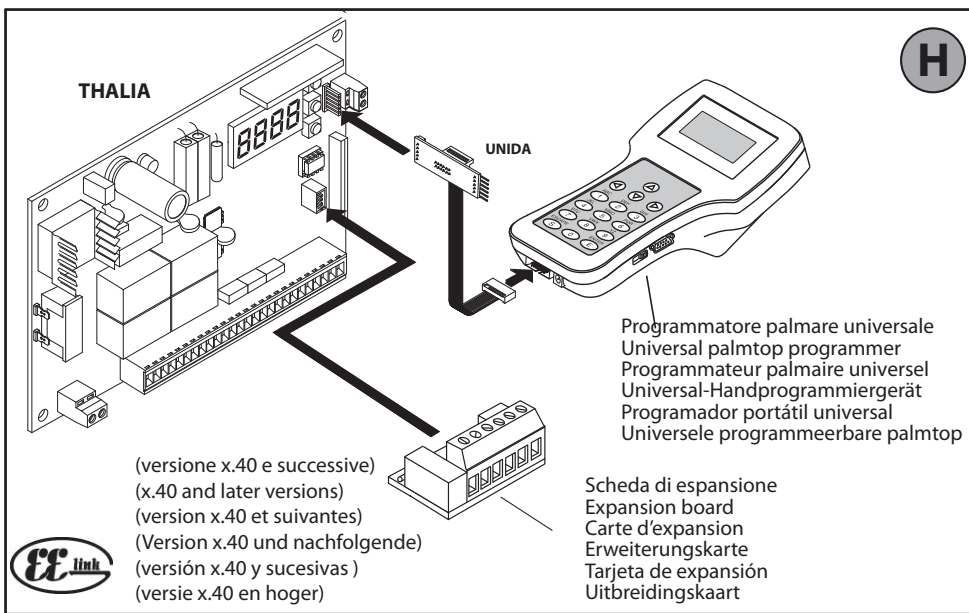
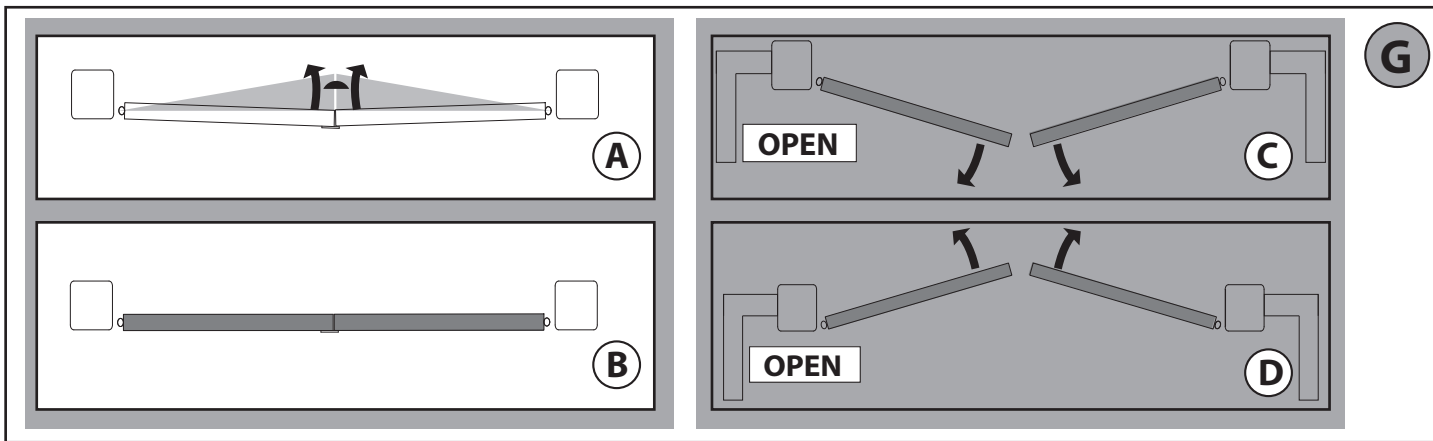

ACCESS MENUS FIG. 1

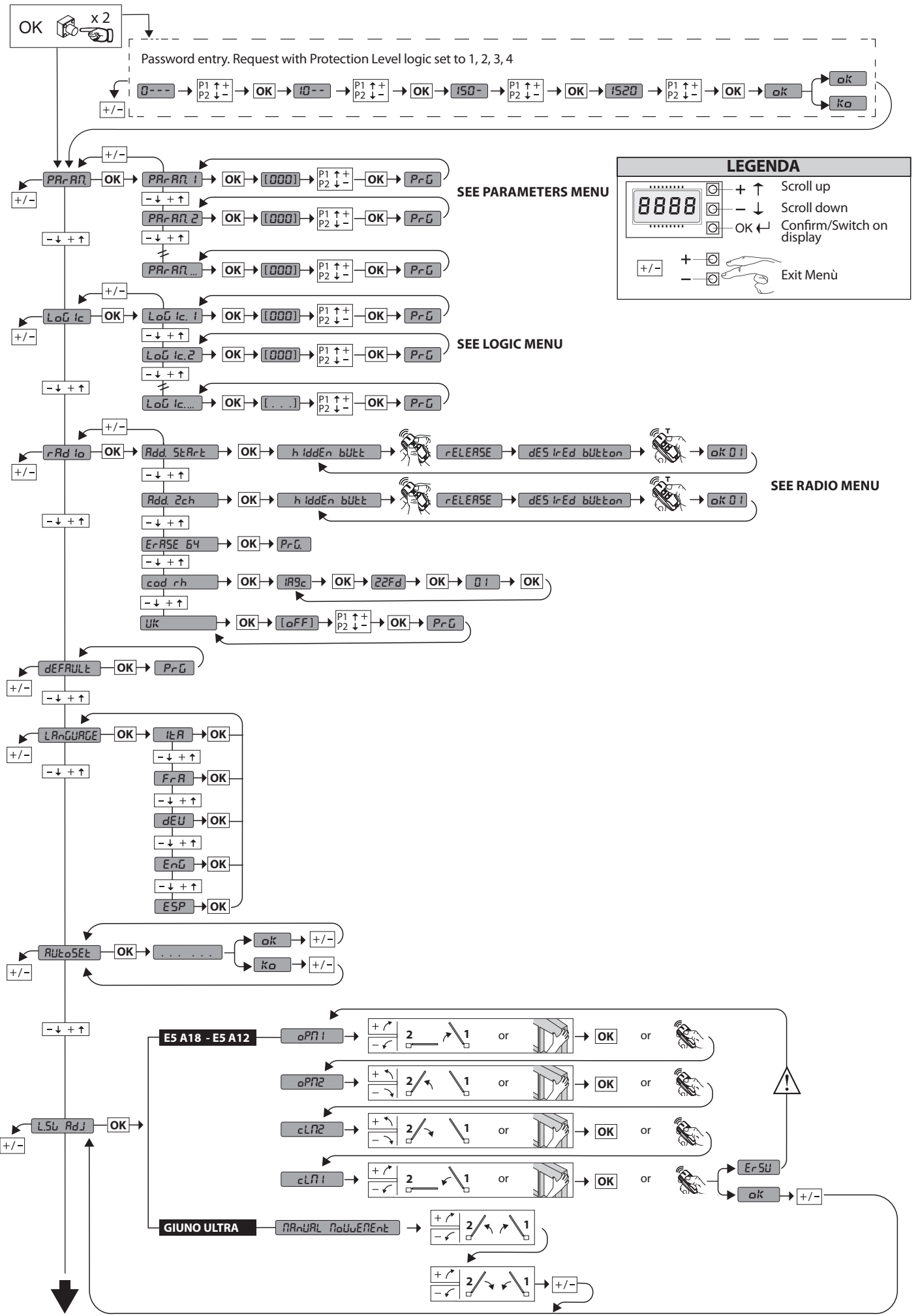

ACCESS MENUS FIG. 1

D814123 0AA00_01

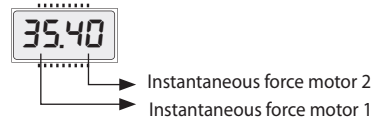
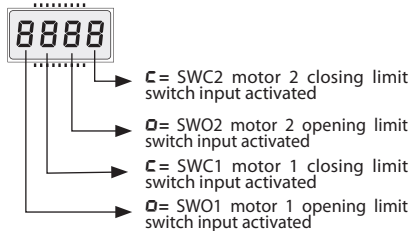
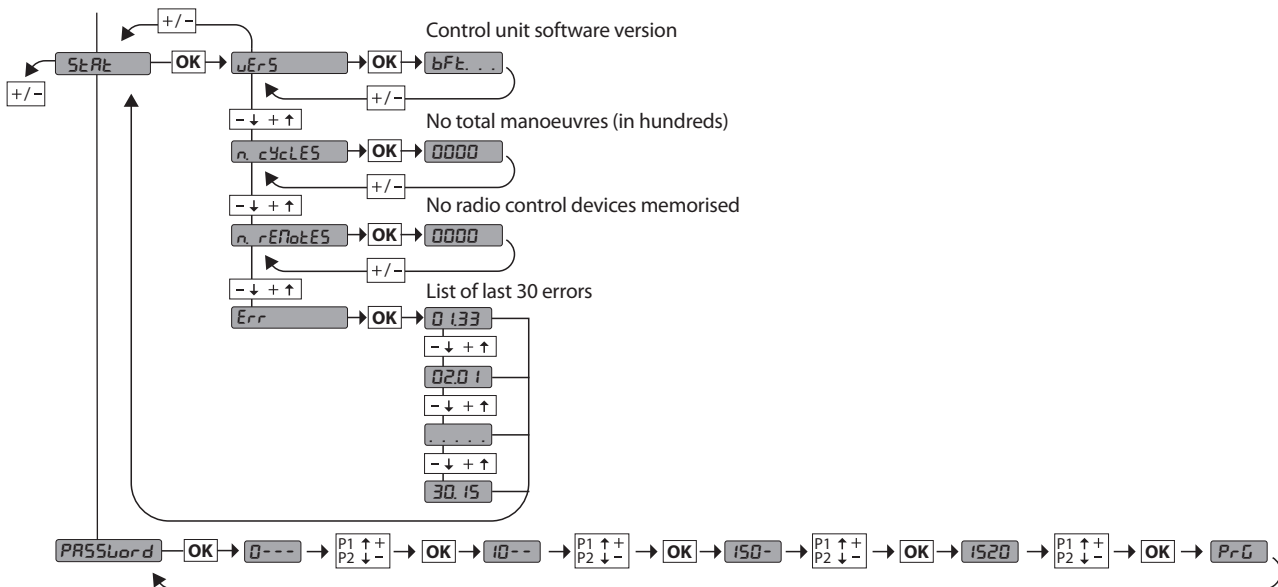

Diagnosics code	DESCRIPTION	NOTES
StErE	START E external start input activated	
StErI	START I internal start input activated	
oPEn	OPEN input activated	
cLS	CLOSE input activated	
PEd	PED pedestrian input activated	
tIME	TIMER input activated	
StoP	STOP input activated	
Phot	Activation of PHOT photocell input or, if configured as verified photocell, Activation of the associated FAULT input	
PhoP	Activation of PHOT OP opening photocell input or, if configured as active verified photocell only when opening, Activation of the associated FAULT input	
PhcL	Activation of PHOT CL closing photocell input or, if configured as active verified photocell only when closing, Activation of the associated FAULT input	
bAr	Activation of BAR safety edge input or, if configured as verified safety edge, Activation of the associated FAULT input	
bArO	Activation of BAR safety edge input with ACTIVE reversal ONLY WHILE OPENING, or, if configured as verified safety edge active only while opening, Activation of the associated FAULT input	
bArC	Activation of BAR safety edge input with ACTIVE reversal ONLY WHILE CLOSING, or, if configured as verified safety edge active only while closing, Activation of the associated FAULT input	
SEt	The board is standing by to perform a complete opening-closing cycle uninterrupted by intermediate stops in order to acquire the torque required for movement. WARNING! Obstacle detection not active	
Er01	Photocell test failed	Check photocell connection and/or logic settings
Er02	Safety edge test failed	Check safety edge connection and/or logic settings
Er03	Opening photocell test failed	Check photocell connection and/or parameter/logic setting
Er04	Closing photocell test failed	Check photocell connection and/or parameter/logic setting
Er06	8k2 safety edge test failed	Check safety edge connection and/or parameter/logic settings
Er07	Opening safety edge test failed	Check safety edge connection and/or parameter/logic settings
Er08	Closing safety edge test failed	Check safety edge connection and/or parameter/logic settings
Er1H*	Board hardware test error	- Check connections to motor - Hardware problems with board (contact technical assistance)
Er2H*	Encoder error	- Motor or encoder signal power cables inverted/disconnected or incorrect programming (see Fig. E) - Actuator movement is too slow or stopped with respect to programmed operation.
Er3H*	Reverse due to obstacle - Amperestop	Check for obstacles in path
Er4H*	Thermal cutout	Allow automated device to cool
Er5H*	Communication error with remote devices	Check connection with serial-connected accessory devices and/or expansion boards
Er70, Er71, Er74, Er75	Internal system supervision control error.	Try switching the board off and back on again. If the problem persists, contact the technical assistance department.
Er72	Consistency error of the control unit's parameters (Logics and Parameters)	Pressing OK the detected settings are confirmed. The board will keep on working with the detected settings. ⚠ The board settings must be checked (Parameters and Logics)
Er73	D-track parameter error	Pressing OK, the board will keep on working with D-track as a default. ⚠ An autotest is required
Er5u	Error during limit switch adjustment Only for E5 BT A18 / E5 BT A12	Motor or encoder signal power cables inverted/disconnected or incorrect programming. (see Fig. E)
ErF3	Error in the configuration of the logics (SAFE inputs, motor type)	Check that the SAFE logic or motor type configuration is correct.

*H= 0, 1, ..., 9, A, B, C, D, E, F

INSTALLATION MANUAL

2) GENERAL INFORMATION

The **THALIA** control panel comes with standard factory settings. Any change must be made using the programmer with built-in display or universal handheld programmer. The Control unit completely supports the EELINK protocol. Its main features are:

- Control of 1 or 2 24V BT motors
Note: 2 motors of the same type must be used.
- Electronic torque control with obstacle detection
- Limit switch control inputs based on motor selected
- Separate inputs for safety devices
- Built-in radio receiver rolling code with transmitter cloning.

The board has a terminal strip of the removable kind to make maintenance or replacement easier. It comes with a series of prewired jumpers to make the installer's job on site easier.

The jumpers concern terminals: 70-71, 70-72, 70-74. If the above-mentioned terminals are being used, remove the relevant jumpers.

TESTING

The **THALIA** panel controls (checks) the start relays and safety devices (photocells) before performing each opening and closing cycle.

If there is a malfunction, make sure that the connected devices are working properly and check the wiring.

3) TECHNICAL SPECIFICATIONS

Power supply	220-230V 50/60 Hz*
Low voltage/mains insulation	> 2MΩ 500V ---
Operating temperature range	-20 / +55°C
Thermal overload protection	Software
Dielectric rigidity	mains/LV 3750V~ for 1 minute
Motor output current	max. 7.5A+7.5A

Motor relay switching current	10A
Maximum motor power	180W + 180W (24V ---)
Accessories power supply	24V~ (demand max. 1A) 24V~safe
AUX 0	NO 24V ---powered contact (max.1A)
AUX 3	NO contact (24V~/max.1A)
Fuses	see Fig. C
N° of combinations	4 billion
Max.n° of transmitters that can be memorized	63

(*other voltages to order)

Usable transmitter versions:

All ROLLING CODE transmitters compatible with ((€R-Ready))

4) TUBE ARRANGEMENT Fig. A

5) TERMINAL BOARD WIRING Fig. C

WARNINGS - When performing wiring and installation, refer to the standards in force and, whatever the case, apply good practice principles.

Wires carrying different voltages must be kept physically separate from each other, or they must be suitably insulated with at least 1mm of additional insulation. Wires must be secured with additional fastening near the terminals, using devices such as cable clamps.

All connecting cables must be kept far enough away from the dissipater.

WARNING! For connection to the mains power supply, use a multicore cable with a cross-sectional area of at least 3x1.5mm² of the kind provided for by the regulations in force. To connect the motors, use a cable with a cross-sectional area of at least 1.5mm² of the kind provided for by the regulations in force. The cable must be type H05RN-F at least.

	Terminal	Definition	Description
Power supply	L	LINE	Single-phase power supply 220-230V 50/60 Hz*
	N	NEUTRAL	
	JP5	TRANSF PRIM	Transformer primary winding connection, 220-230V.
	JP7		
	JP21	TRANSF SEC	Board power supply: 24V~ Transformer secondary winding 24V= Buffer battery power supply
Motor	10	MOT1 +	Connection motor 1. Time lag during closing. Check connections shown in Fig.E
	11	MOT1 -	
	14	MOT2 +	Connection motor 2. Time lag during opening. Check connections shown in Fig.E
	15	MOT2 -	
Aux	20	AUX 0 - 24V POWERED CONTACT (N.O.) (MAX. 1A)	AUX 0 configurable output - Default setting FLASHING LIGHT. 2ND RADIO CHANNEL/ SCA GATE OPEN LIGHT/ COURTESY LIGHT command/ ZONE LIGHT command/ STAIR LIGHT/ GATE OPEN ALARM/ FLASHING LIGHT/ SOLENOID LATCH/ MAGNETIC LOCK/ MAINTENANCE/ FLASHING LIGHT AND MAINTENANCE. Refer to "AUX output configuration" table.
	21		
	26	AUX 3 - FREE CONTACT (N.O.) (Max. 24V 1A)	AUX 3 configurable output - Default setting 2ND RADIO CHANNEL Output. 2ND RADIO CHANNEL/ SCA GATE OPEN LIGHT/ COURTESY LIGHT command/ ZONE LIGHT command/ STAIR LIGHT/ GATE OPEN ALARM/ FLASHING LIGHT/ SOLENOID LATCH/ MAGNETIC LOCK. Refer to "AUX output configuration" table.
	27		
Limit switch for ELI 250 BT VIRGOSMART BT A ELI BT A35 LS ELI BT A40 LS 5 wires	41	+ REF SWE	Limit switch common
	42	SWC 1	Motor 1 closing limit switch SWC1 (N.C.).
	43	SWO 1	Motor 1 opening limit switch SWO1 (N.C.).
	44	SWC 2	Motor 2 closing limit switch SWC2 (N.C.).
	45	SWO 2	Motor 2 opening limit switch SWO2 (N.C.).
Limit switch for PHOBOS N BT IGEA BT SUB BT PHOBOS BT A KUSTOS BT A VIRGO SMART BT A 3 wires	42	SW 1	Limit switch control motor 1. For actuators with single-wire limit switch control.
	43	SW 2	Limit switch control motor 2. For actuators with single-wire limit switch control.
Limit switch for GIUNO ULTRA BT A20 GIUNO ULTRA BT A50 E5 BT A18 E5 BT A12	40	- REF SWE	Limit switch common
	42	SW 1	Limit switch control motor 1.
	43	SW 2	Limit switch control motor 2.
Limit switch for ELI BT A35 LS ELI BT A40 LS	40	- REF SWE	Encoder power supply, white cable
	41	+ REF SWE	Encoder power supply, brown cable
	42	ENC M1	Engine 1 encoder signal, green cable ⚠ Close the jumper JP28
	43	ENC M2	Engine 2 encoder signal, green cable ⚠ Close the jumper JP29
Accessories power supply	50	24V-	Accessories power supply output.
	51	24V+	
	52	24Vsafe+	Tested safety device power supply output (photocell transmitter and safety edge transmitter). Output active only during operating cycle.

INSTALLATION MANUAL

D814123 0AA00_01

	Terminal	Definition	Description
Commands	60	Common	IC 1 and IC 2 inputs common
	61	IC 1	Configurable command input 1 (N.O.) - Default START E. START E / START I / OPEN / CLOSE / PED / TIMER / TIMER PED Refer to the "Command input configuration" table.
	62	IC 2	Configurable command input 2 (N.O.) - Default PED. START E / START I / OPEN / CLOSE / PED / TIMER / TIMER PED Refer to the "Command input configuration" table.
Safety devices	70	Common	STOP, SAFE 1 and SAFE 2 inputs common
	71	STOP	The command stops movement. (N.C.) If not used, leave jumper inserted.
	72	SAFE 1	Configurable safety input 1 (N.C.) - Default PHOT. PHOT / PHOT TEST / PHOT OP / PHOT OP TEST / PHOT CL / PHOT CL TEST / BAR / BAR TEST / BAR 8K2 / BAR OP / BAR OP TEST / BAR 8K2 OP / BAR CL / BAR CL TEST / BAR 8K2 CL Refer to the "Safety input configuration" table.
	73	FAULT 1	Test input for safety devices connected to SAFE 1.
	74	SAFE 2	Configurable safety input 2 (N.C.) - Default BAR. PHOT / PHOT TEST / PHOT OP / PHOT OP TEST / PHOT CL / PHOT CL TEST / BAR / BAR TEST / BAR 8K2 / BAR OP / BAR OP TEST / BAR 8K2 OP / BAR CL / BAR CL TEST / BAR 8K2 CL Refer to the "Safety input configuration" table.
	75	FAULT 2	Test input for safety devices connected to SAFE 2.
Antenna	Y	ANTENNA	Antenna input.
	#	SHIELD	Use an antenna tuned to 433MHz. Use RG58 coax cable to connect the Antenna and Receiver. Metal bodies close to the antenna can interfere with radio reception. If the transmitter's range is limited, move the antenna to a more suitable position.

AUX output configuration

Aux logic= 0 - 2ND RADIO CHANNEL output. Contact stays closed for 1s when 2nd radio channel is activated.
Aux logic= 1 - SCA GATE OPEN LIGHT output. Contact stays closed during opening and with leaf open, intermittent during closing, open with leaf closed.
Aux logic= 2 - COURTESY LIGHT command output. Contact stays on for 90 seconds after the last operation.
Aux logic= 3 - ZONE LIGHT command output. Contact stays closed for the full duration of operation.
Aux logic= 4 - STAIR LIGHT output. Contact stays closed for 1 second at start of operation.
Aux logic= 5 - GATE OPEN ALARM output. Contact stays closed if the leaf stays open for double the set TCA time.
Aux logic= 6 - FLASHING LIGHT output. Contact stays closed while leaves are operating.
Aux logic= 7 - SOLENOID LATCH output. Contact stays closed for 2 seconds each time gate is opened.
Aux logic= 8 - MAGNETIC LOCK output. Contact stays closed while gate is closed.
Aux logic= 9 - MAINTENANCE output. Contact stays closed once the value set for the Maintenance parameter is reached, to report that maintenance is required.
Aux logic= 10 - FLASHING LIGHT AND MAINTENANCE output. Contact stays closed while leaves are operating. If the value set for the Maintenance parameter is reached, once the gate has finished moving and the leaf is closed, the contact closes for 10 sec. and opens for 5 sec. 4 times to report that maintenance is required.

Command input configuration

IC logic= 0 - Input configured as Start E. Operation according to 5LEP-bY-5LEP logic. External start for traffic light control.
IC logic= 1 - Input configured as Start I. Operation according to 5LEP-bY-5LEP logic. Internal start for traffic light control.
IC logic= 2 - Input configured as Open. The command causes the leaves to open. If the input stays closed, the leaves stay open until the contact is opened. When the contact is open, the automated device closes following the TCA time, where activated.
IC logic= 3 - Input configured as Closed. The command causes the leaves to close.
IC logic= 4 - Input configured as Ped. The command causes the leaf to open to the pedestrian (partial) opening position. Operation according to 5LEP-bY-5LEP logic
IC logic= 5 - Input configured as Timer. Operation same as open except closing is guaranteed even after a mains power outage.
IC logic= 6 - Input configured as Timer Ped. The command causes the leaf to open to the pedestrian (partial) opening position. If the input stays closed, the leaf stays open until the contact is opened. If the input stays closed and a Start E, Start I or Open command is activated, a complete opening-closing cycle is performed before returning to the pedestrian opening position. Closing is guaranteed even after a mains power outage.

Safety input configuration

SAFE logic= 0 - Input configured as Phot (photocell) non tested (*). (fig.F, ref.1). Enables connection of devices not equipped with supplementary test contacts. When beam is broken, photocells are active during both opening and closing. When beam is broken during closing, movement is reversed only once the photocell is cleared. If not used, leave jumper inserted.
SAFE logic= 1 - Input configured as Phot test (tested photocell). (fig.F, ref.2). Switches photocell testing on at start of operation. When beam is broken, photocells are active during both opening and closing. When beam is broken during closing, movement is reversed only once the photocell is cleared.
SAFE logic= 2 - Input configured as Phot op (photocell active during opening only) non tested (*). (fig.F, ref.1). Enables connection of devices not equipped with supplementary test contacts. In the event beam is broken, photocell operation is disabled during closing. During opening, stops motion for as long as the photocell beam stays broken. If not used, leave jumper inserted.
SAFE logic= 3 - Input configured as Phot op test (tested photocell active during opening only) (fig.F, ref.2). Switches photocell testing on at start of operation. In the event beam is broken, photocell operation is disabled during closing. During opening, stops motion for as long as the photocell beam stays broken.
SAFE logic= 4 - Input configured as Phot cl (photocell active during closing only) non tested (*). (fig.F, ref.1). Enables connection of devices not equipped with supplementary test contacts. In the event beam is broken, photocell operation is disabled during opening. During closing, movement is reversed immediately. If not used, leave jumper inserted.
SAFE logic= 5 - Input configured as Phot cl test (tested photocell active during closing only) (fig.F, ref.2). Switches photocell testing on at start of operation. In the event beam is broken, photocell operation is disabled during opening. During closing, movement is reversed immediately.
SAFE logic= 6 - Input configured as Bar (safety edge) non tested (*). (fig.F, ref.3). Enables connection of devices not equipped with supplementary test contacts. The command reverses movement for 2 sec.. If not used, leave jumper inserted.
SAFE logic= 7 - Input configured as Bar (tested safety edge) (fig.F, ref.4). Switches safety edge testing on at start of operation. The command reverses movement for 2 sec.
SAFE logic= 8 - Input configured as Bar 8k2 (fig.F, ref.5). Input for resistive edge 8K2. The command reverses movement for 2 sec.

Safety input configuration

SAFE logic=9 Input configured as Bar op, safety edge with active inversion only while opening, if activated while closing, the automation stops (STOP) (Fig. F, ref. 3). Allows connecting devices not fitted with supplementary test contact. The operation while opening causes the movement to be reversed for 2 seconds, the operation while closing causes the automation to stop. If not used, leave jumper inserted.
SAFE logic=10 Input configured as Bar op test, safety edge checked with active inversion only while opening, if activated while closing, the automation stops (STOP) (Fig. F, ref. 4). Activates testing safety edges when starting operation. The operation while opening causes the movement to be reversed for 2 seconds, the operation while closing causes the automation to stop.
SAFE logic=11 Input configured as Bar 8k2 op, 8k2 safety edge with active inversion only while opening, if activated while closing, the automation stops (STOP) (Fig. F, ref. 5). The operation while opening causes the movement to be reversed for 2 seconds, the operation while closing causes the automation to stop.
SAFE logic=12 Input configured as Bar cl, safety edge with active inversion only while closing, if activated while opening, the automation stops (STOP) (Fig. F, ref. 3). Allows connecting devices not fitted with supplementary test contact. The operation while closing causes the movement to be reversed for 2 seconds, the operation while opening causes the automation to stop. If not used, leave jumper inserted.
SAFE logic=13 Input configured as Bar cl test, safety edge checked with active inversion only while closing, if activated while opening, the automation stops (STOP) (Fig. F, ref. 4). Activates testing safety edges when starting operation. The operation while closing causes the movement to be reversed for 2 seconds, the operation while opening causes the automation to stop.
SAFE logic=14 Input configured as Bar 8k2 cl, safety edge with active inversion only while closing, if activated while opening, the automation stops (STOP) (Fig. F, ref. 5). The operation while closing causes the movement to be reversed for 2 seconds, the operation while opening causes the automation to stop.

(*) If "D" type devices are installed (as defined by EN12453), connect in unverified mode, foresee mandatory maintenance at least every six months.

6) MOTOR WIRING Fig. E

7) SAFETY DEVICES

Note: only use receiving safety devices with free changeover contact.

7.1) TESTED DEVICES Fig. F

7.2) CONNECTION OF 1 PAIR OF NON-CHECKED PHOTOCELLS FIG. D1

7.3) CONNECTION OF 1 PAIR OF CHECKED PHOTOCELLS FIG. D2

8) CALLING UP MENUS: FIG. 1

8.1) PARAMETERS MENU (PARAMETERS TABLE "A")

8.2) LOGIC MENU (LOGIC TABLE "B")

8.3) RADIO MENU (RADIO TABLE "C")

IMPORTANT NOTE: THE FIRST TRANSMITTER MEMORIZED MUST BE IDENTIFIED BY ATTACHING THE KEY LABEL (MASTER).

In the event of manual programming, the first transmitter assigns the RECEIVER'S KEY CODE: this code is required to subsequently clone the radio transmitters.

The Clonix built-in on-board receiver also has a number of important advanced features:

- Cloning of master transmitter (rolling code or fixed code).
- Cloning to replace transmitters already entered in receiver.
- Transmitter database management.
- Receiver community management.

To use these advanced features, refer to the universal handheld programmer's instructions and to the general receiver programming guide.

8.4) DEFAULT MENU (DEFAULT)

Restores the controller's DEFAULT factory settings. Following this reset, you will need to run the AUTOSET function again.

8.5) LANGUAGE MENU (LANGUAGE)

Used to set the programmer's language on the display.

8.6) AUTOSET MENU (AUTOSET)

- Launch an autosegment operation by going to the relevant menu.
- As soon as you press the OK button, the "....." message is displayed and the control unit commands the device to perform a full cycle (opening followed by closing), during which the minimum torque value required to move the leaf is set automatically. The number of cycles required for the autosegment function can range from 1 to 3. During this stage, it is important to avoid breaking the photocells' beams and not to use the START and STOP commands or the display. Once this operation is complete, the control unit will have automatically set the optimum torque values. Check them and, where necessary, edit them as described in the programming section.

WARNING!! Check that the force of impact measured at the points provided for by standard EN 12445 is lower than the value laid down by standard EN 12453.

Impact forces can be reduced by using deformable edges.

Warning!! While the autosegment function is running, the obstacle detection function is not active. Consequently, the installer must monitor the automated system's movements and keep people and property out of range of the automated system.

8.7) INSTALLATION TEST PROCEDURE

1. Run the AUTOSET cycle (*)
2. Check the impact forces: if they fall within the limits (**) skip to point 10 of the procedure, otherwise
3. Where necessary, adjust the speed and sensitivity (force) parameters: see parameters table.
4. Check the impact forces again: if they fall within the limits (**) skip to point 10 of the procedure, otherwise
5. Apply a shock absorber profile
6. Check the impact forces again: if they fall within the limits (**) skip to point 10 of the procedure, otherwise
7. Apply pressure-sensitive or electro-sensitive protective devices (such as a safety edge) (**)
8. Check the impact forces again: if they fall within the limits (**) skip to point 10 of the procedure, otherwise
9. Allow the drive to move only in "Deadman" mode
10. Make sure all devices designed to detect obstacles within the system's operating range are working properly

(*) Before running the autosegment function, make sure you have performed all the assembly and make-safe operations correctly, as set out in the installation warnings in the drive's manual.

(**) Based on the risk analysis, you may find it necessary to apply sensitive protective devices anyway

8.8) LIMIT STOP ADJUSTMENT MENU (LIMIT STOP)

Used to adjust the limit stops for motors equipped with encoder; moreover, for motors equipped with independent limit stop wiring harness allows the correct positioning of the leaf for the subsequent limit stop adjustment. For

motors not specified, the menu is not active and the message "unavailable" is shown on the display

NOTE: these manoeuvres are performed in person preset mode, at slow speed, without the intervention of the safety devices.

8.8.1) GIUNO ULTRA BT A20, GIUNO ULTRA BT A50

Using the „+/-“ buttons on the display, bring the leaf in the desired position. To adjust the limit stops, refer to the settings for limit stop adjustment provided in the GIUNO ULTRA motor manual.

8.8.2) E5 BT A12, E5 BT A18

Using the „+/-“ buttons on the display, bring the leaf in the position indicated by the display (opening or closing). Once the desired position is reached, confirm the position by pressing the OK button. For E5 motors, the leaf can be manually positioned close to the limit stops by pushing the gate; then move the gate using the „+/-“ button until it is against the mechanical stopper. To confirm the position, or use the OK button or the radio control (previously stored).

9) CLOSING LIMIT SWITCH PRESSURE Fig. G Ref. A-B

OPENING DIRECTION Fig. E

10) CONNECTION WITH EXPANSION BOARDS AND UNIVERSAL HANDHELD PROGRAMMER VERSION> V1.40 (Fig. H) Refer to specific manual.

11) U-LINK OPTIONAL MODULES

Refer to the U-link instructions for the modules.

The use of some models causes lowered radio capacity. Adjust the system using an appropriate antenna tuned to 433MHz.

12) SOLENOID LOCK Fig. I

SOLENOID LOCK

WARNING: In the case of leaves longer than 3m, it is essential to install a solenoid lock.

Fig. I shows a sample connection of an ECB 24V~ solenoid latch connected to the THALIA control panel.

In order to control the solenoid lock, the THALIA panel needs a special board mod. ME BT.

13) RESTORING FACTORY SETTINGS (Fig.J)

WARNING: this operation will restore the control unit's factory settings and all transmitters stored in its memory will be deleted.

WARNING! Incorrect settings can result in damage to property and injury to people and animals.

- Cut off power to the board (Fig.J ref.1)
- Open the Stop input and press the - and OK keys together (Fig.J ref.2)
- Switch on the board's power (Fig.J ref.3)
- The display will read RST; confirm within 3 sec. by pressing the OK key (Fig.J ref.4)
- Wait for the procedure to finish (Fig.J ref.5)
- Procedure finished (Fig.J ref.6)

WARNING! Incorrect settings can result in damage to property and injury to people and animals.

WARNING: Check that the force of impact measured at the points provided for by standard EN 12445 is lower than the value laid down by standard EN 12453.



Impact forces can be reduced by using deformable edges.

For best results, it is advisable to run the autosegment function with the motors idle (i.e. not overheated by a considerable number of consecutive operations).

INSTALLATION MANUAL

D814123 0AA00_01



TABLE "A" - PARAMETERS MENU - (PR-RF)

Parameter	min.	max.	Default	Personal	Definition	Description
oPEn dELAY tIME	0	10	3		Motor 2 opening delay time [s]	Motor 2 opening delay time with respect to motor 1.
cLS dELAY tIME	0	25	6		Motor 1 closing delay time [s]	Motor 1 closing delay time with respect to motor 2. NOTE: if the time is set to maximum, before starting, engine 1 waits for the complete shut down of engine 2.
tCtA	0	120	10		Automatic closing time [s]	Waiting time before automatic closing.
tRF.Lght. cLr.t	1	180	40		Time-to-clear traffic light zone [s]	Time-to-clear for the zone run through by traffic controlled by the traffic light.
oPd ISt. SlOwD	0	50	10		Slow-down distance during opening [%]	Slow-down distance for motor(s) during opening, given as a percentage of total travel. WARNING: Once the parameter has been edited, a complete uninterrupted opening-closing cycle is required. WARNING: when the display reads "SET", obstacle detection is not active. ATTENTION: with actuators with integrated locks, the permanently active slowdown to a value higher than 5 is mandatory. WARNING: in GIUNO, the slow-down distance is set with the sliding sensors ATTENTION: for the ELI BT A35 engine type, the slowing cannot be excluded; values below 10% will be considered to be 10%.
cLd ISt. SlOwD	0	50	10		Slow-down distance during closing [%]	Slow-down distance for motor(s) during closing, given as a percentage of total travel. WARNING: Once the parameter has been edited, a complete uninterrupted opening-closing cycle is required. WARNING: when the display reads "SET", obstacle detection is not active. ATTENTION: with actuators with integrated locks, the permanently active slowdown to a value higher than 5 is mandatory. WARNING: in GIUNO, the slow-down distance is set with the sliding sensors ATTENTION: for the ELI BT A35 engine type, the slowing cannot be excluded; values below 10% will be considered to be 10%.
d ISt.dEcEL	0	50	15		Deceleration distance [%]	Deceleration distance (switch from running speed to slow-down speed) for motor(s) both during opening and during closing, given as a percentage of total travel. WARNING: Once the parameter has been edited, a complete uninterrupted opening-closing cycle is required. WARNING: when the display reads "SET", obstacle detection is not active.
PRt IRL oPEn InG	10	99	99		Partial opening M1 [%]	Partial opening distance as a percentage of total opening following activation of PED pedestrian command.
oPForcE	1	99	50		Leaf force during opening [%]	Force exerted by leaf/leaves during opening. This is the percentage of force delivered, beyond the force stored during the autoset cycle (and subsequently updated), before an obstacle alarm is generated. The parameter is set automatically by the autoset function.  WARNING: It affects impact force directly: make sure that current safety requirements are met with the set value (*). Install anti-crush safety devices where necessary (**).
cLSForcE	1	99	50		Leaf force during closing [%]	Force exerted by leaf/leaves during closing. This is the percentage of force delivered, beyond the force stored during the autoset cycle (and subsequently updated), before an obstacle alarm is generated. The parameter is set automatically by the autoset function.  WARNING: It affects impact force directly: make sure that current safety requirements are met with the set value (*). Install anti-crush safety devices where necessary (**).
oP SPEED	15	99	99		Opening speed [%]	Percentage of maximum speed that can be reached by motor(s) during opening. WARNING: Once the parameter has been edited, a complete uninterrupted opening-closing cycle is required. WARNING: when the display reads "SET", obstacle detection is not active.
cL SPEED	15	99	99		Closing speed [%]	Percentage of maximum speed that can be reached by motor(s) during closing. WARNING: Once the parameter has been edited, a complete uninterrupted opening-closing cycle is required. WARNING: when the display reads "SET", obstacle detection is not active.
SlOw SPEED	15	99	25		Slow-down speed [%]	Opening and closing speed of motor(s) during slow-down stage, given as a percentage of maximum running speed. WARNING: Once the parameter has been edited, a complete uninterrupted opening-closing cycle is required. WARNING: When the display reads "SET", obstacle detection is not active. ATTENTION: for the ELI BT A35 engine type, the slowing cannot be excluded; values below 50% will be considered to be 50%.
MA InTE- nAnCE	0	250	0		Programming number of operations for maintenance threshold [in hundreds]	Allows you to set a number of operations after which the need for maintenance will be reported on the AUX output configured as Maintenance or Flashing Light and Maintenance.

(*) In the European Union, apply standard EN 12453 for force limitations, and standard EN 12445 for measuring method.

(**) Impact forces can be reduced by using deformable edges.

TABLE "B" - LOGIC MENU - (L0G Ic)

Logic	Definition	Default	Cross out setting used	Optional extras
Motor type <i>Motor type</i>	(Set the type of motor connected to the board).	0	0	Motors not active
			1	ELI 250 BT
			2	PHOBOS N BT
			3	IGEA BT
			4	NOT MANAGED
			5	NOT MANAGED
			6	SUB BT
			7	KUSTOS BT A - PHOBOS BT A
			8	GIUNO ULTRA BT A 20 - GIUNO ULTRA BT A50
			9	VIRGO SMART BT A - 5 wires
			10	VIRGO SMART BT A - 3 wires
			11	E5 BT A18
			12	E5 BT A12
			13	ELI BT A40 LS
			14	ELI BT A35 LS
			15	ELI BT A35
			16	ELI BT A40
TCA	Automatic Closing Time	0	0	Logic not enabled
			1	Switches automatic closing on
FAST CLS	Fast closing	0	0	Logic not enabled
			1	Closes 3 seconds after the photocells are cleared before waiting for the set TCA to elapse.
STEP-BY-STEP <i>Step-by-step movement</i>	Step-by-step movement	0	0	Inputs configured as Start E, Start I, Ped operate with 4-step logic.
			1	Inputs configured as Start E, Start I, Ped operate with 3-step logic. Pulse during closing reverses movement.
			2	Inputs configured as Start E, Start I, Ped operate with 2-step logic. Movement reverses with each pulse.
PRE-ALARIN	Pre-alarm	0	0	The flashing light comes on at the same time as the motor(s) start.
			1	The flashing light comes on approx. 3 seconds before the motor(s) start.
hold-to-run	Deadman	0	0	Pulse operation.
			1	Deadman mode. Input 61 is configured as OPEN UP. Input 62 is configured as CLOSE UP. Operation continues as long as the OPEN UP or CLOSE UP keys are held down.  WARNING: safety devices are not enabled.
			2	Emergency Deadman mode. Usually pulse operation. If the board fails the safety device tests (photocell or safety edge, Er0x) 3 times in a row, the device is switched to Deadman mode, which will stay active until the OPEN UP or CLOSE UP keys are released. Input 61 is configured as OPEN UP. Input 62 is configured as CLOSE UP.  WARNING: with the device set to Emergency Deadman mode, safety devices are not enabled.
ibl OPEN	Block pulses during opening	0	0	Pulse from inputs configured as Start E, Start I, Ped has effect during opening.
			1	Pulse from inputs configured as Start E, Start I, Ped has no effect during opening.
ibl TCA	Block pulses during TCA	0	0	Pulse from inputs configured as Start E, Start I, Ped has effect during TCA pause.
			1	Pulse from inputs configured as Start E, Start I, Ped has no effect during TCA pause.
ibl CLOSE	Block pulses during closing	0	0	Pulse from inputs configured as Start E, Start I, Ped has effect during closing.
			1	Pulse from inputs configured as Start E, Start I, Ped has no effect during closing.
rAN bLob COP	Hammer during opening	0	0	Logic not enabled
			1	Before opening completely, the gate pushes for approx. 2 seconds as it closes. This allows the solenoid lock to be released more easily. IMPORTANT - Do not use this function if suitable mechanical stops are not in place.
rAN bLob cCL	Hammer during closing	0	0	Logic not enabled
			1	Before closing completely, the gate pushes for approx. 2 seconds as it opens. This allows the solenoid lock to be released more easily. IMPORTANT - Do not use this function if suitable mechanical stops are not in place.
bLoc PER5 ISt	Stop maintenance	0	0	Logic not enabled
			1	If motors stay idle in fully open or fully closed position for more than one hour, they are switched on in the direction of the stop for approx. 3 seconds. This operation is performed every hour. NB: In hydraulic motors, this function serves to compensate a possible reduction in the volume of oil due to a drop in temperature during extended pauses, such as during the night, or due to internal leakage. IMPORTANT - Do not use this function if suitable mechanical stops are not in place.
PrESS Sbc	Closing limit switch pressure	0	0	Movement is stopped only when the closing limit switch trips: in this case, the tripping of the closing limit switch must be adjusted accurately (Fig.G Ref.B).
			1	Use when there is a mechanical stop in closed position. This function allows leaves to press against the mechanical stop without the Amperostop sensor interpreting this as an obstacle. Thus the rod continues its stroke for a few seconds after meeting the closing limit switch or as far as the mechanical stop. In this way, the leaves come to rest perfectly against the stop by allowing the closing limit switches to trip slightly earlier (Fig.G Ref.A).
Ice	Ice feature	0	0	The Amperostop safety trip threshold stays at the same set value.
			1	The controller automatically adjusts the obstacle alarm trip threshold at each start up. Check that the force of impact measured at the points provided for by standard EN 12445 is lower than the value laid down by standard EN 12453. If in doubt, use auxiliary safety devices. This feature is useful when dealing with installations running at low temperatures. WARNING: once this feature has been activated, you will need to perform an autoset opening and closing cycle.
1 Motor	1 motor active	0	0	Both motors active (2 leaves).
			1	Only motor 1 active (1 leaf).

INSTALLATION MANUAL

D814123 0AA00_01

Logic	Definition	Default	Cross out setting used	Optional extras
<i>chAnGE Not</i>	Inversion of the motor's phase shift	0	0	Open: M1 starts in advance compared to M2 (opening phase shift). (See Fig.E) Closure: M2 starts in advance compared to M1 (closing phase shift). (See Fig.E) Pedestrian manoeuvre is performed by M1
			1	Open: M2 starts in advance compared to M1 (opening phase shift). (See Fig.E) Closure: M1 starts in advance compared to M2 (closing phase shift). (See Fig.E) Pedestrian manoeuvre is performed by M2
<i>oPEn in othEr dIrEct.</i>	Open in other direction	0	0	Standard operating mode (See Fig.E).
			1	Opens in other direction to standard operating mode (See Fig. E)
<i>SAFE 1</i>	Configuration of safety input SAFE 1. 72	0	0	Input configured as Phot (photocell).
			1	Input configured as Phot test (tested photocell).
			2	Input configured as Phot op (photocell active during opening only).
			3	Input configured as Phot op test (tested photocell active during opening only).
<i>SAFE 2</i>	Configuration of safety input SAFE 2. 74	6	4	Input configured as Phot cl (photocell active during closing only).
			5	Input configured as Phot cl test (tested photocell active during closing only).
			6	Input configured as Bar, safety edge.
			7	Input configured as Bar, tested safety edge.
			8	Input configured as Bar 8k2.
			9	Input configured as Bar OP, safety edge with inversion active only while opening. If while closing, the movement stops.
			10	Input configured as Bar OP TEST, safety edge tested with inversion active only while opening. If while closing, the movement stops.
			11	Input configured as Bar OP 8k2, safety edge with inversion active only while opening. If while closing, the movement stops.
			12	Input configured as Bar CL, safety edge with inversion active only while closing. If while opening, the movement stops.
			13	Input configured as Bar CL TEST, safety edge tested with inversion active only while closing. If while opening, the movement stops.
<i>IC 1</i>	Configuration of command input IC 1. 61	0	0	Input configured as Start E.
			1	Input configured as Start I.
			2	Input configured as Open.
			3	Input configured as Close.
<i>IC 2</i>	Configuration of command input IC 2. 62	4	4	Input configured as Ped.
			5	Input configured as Timer.
			6	Input configured as Timer Pedestrian.
<i>AUX 0</i>	Configuration of AUX 0 output. 20-21	6	0	Output configured as 2nd Radio Channel.
			1	Output configured as SCA, gate open light.
			2	Output configured as Courtesy Light command.
			3	Output configured as Zone Light command.
<i>AUX 3</i>	Configuration of AUX 3 output. 26-27	0	4	Output configured as Stair Light
			5	Output configured as Alarm
			6	Output configured as Flashing light
			7	Output configured as Latch
			8	Output configured as Magnetic lock
			9	Output configured as Maintenance
			10	Output configured as Flashing Light and Maintenance.
<i>FIxEd codE</i>	Fixed code	0	0	Receiver is configured for operation in rolling-code mode. Fixed-Code Clones are not accepted.
			1	Receiver is configured for operation in fixed-code mode. Fixed-Code Clones are accepted.
<i>ProtEct ion LEvEL</i>	Setting the protection level	0	0	A - The password is not required to access the programming menus B - Enables wireless memorizing of transmitters. Operations in this mode are carried out near the control panel and do not require access: - Press in sequence the hidden key and normal key (T1-T2-T3-T4) of a transmitter that has already been memorized in standard mode via the radio menu. - Press within 10 sec. the hidden key and normal key (T1-T2-T3-T4) of a transmitter to be memorized. The receiver exits programming mode after 10 sec.: you can use this time to enter other new transmitters by repeating the previous step. C - Enables wireless automatic addition of clones. Enables clones generated with the universal programmer and programmed Replays to be added to the receiver's memory. D - Enables wireless automatic addition of replays. Enables programmed Replays to be added to the receiver's memory. E - The board's parameters can be edited via the U-link network
			1	A - You are prompted to enter the password to access the programming menus The default password is 1234. No change in behaviour of functions B - C - D - E from 0 logic setting
			2	A - You are prompted to enter the password to access the programming menus The default password is 1234. B - Wireless memorizing of transmitters is disabled. C - Wireless automatic addition of clones is disabled. No change in behaviour of functions D - E from 0 logic setting
			3	A - You are prompted to enter the password to access the programming menus The default password is 1234. B - Wireless memorizing of transmitters is disabled. D - Wireless automatic addition of Replays is disabled. No change in behaviour of functions C - E from 0 logic setting
			4	A - You are prompted to enter the password to access the programming menus The default password is 1234. B - Wireless memorizing of transmitters is disabled. C - Wireless automatic addition of clones is disabled. D - Wireless automatic addition of Replays is disabled. E - The option of editing the board's parameters via the U-link network is disabled. Transmitters are memorized only using the relevant Radio menu. IMPORTANT: This high level of security stops unwanted clones from gaining access and also stops radio interference, if any.

INSTALLATION MANUAL

Logic	Definition	Default	Cross out setting used	Optional extras
SERIAL Mode	Serial mode (Identifies how board is configured in a BFT network connection).	0	0	Standard SLAVE: board receives and communicates commands/diagnostics/etc.
			1	Standard MASTER: board sends activation commands (START, OPEN, CLOSE, PED, STOP) to other boards.
ADDRESS	Address	0	[___]	Identifies board address from 0 to 119 in a local BFT network connection. (see U-LINK OPTIONAL MODULES section)
Push Go	Push&Go (Only for E5 BT A12)	0	0	Logic not active
			1	Manually pushing the stopped leaf toward the opening direction determines the automatic opening.
EXP11	Configuration of EXP11 input on input-output expansion board. 1-2	1	0	Input configured as Start E command.
			1	Input configured as Start I command.
			2	Input configured as Open command.
			3	Input configured as Close command.
			4	Input configured as Ped command.
			5	Input configured as Timer command.
			6	Input configured as Timer Pedestrian command.
			7	Input configured as Phot (photocell) safety.
			8	Input configured as Phot op safety (photocell active during opening only).
			9	Input configured as Phot cl safety (photocell active during closing only).
			10	Input configured as Bar safety (safety edge).
			11	Input configured as safety Bar OP, safety edge with inversion active only while opening, if while closing the movement stops.
			12	Input configured as safety Bar CL, safety edge with inversion active only while closing, if while opening the movement stops.
			13	Input configured as Phot test safety, tested photocell. Input 3 (EXPI2) on input/output expansion board is switched automatically to safety device test input, EXPFAULT1.
			14	Input configured as Phot op test safety, tested photocell active only while opening. Input 3 (EXPI2) on input/output expansion board is switched automatically to safety device test input, EXPFAULT1.
			15	Input configured as Phot cl test safety, tested photocell active only while closing. Input 3 (EXPI2) on input/output expansion board is switched automatically to safety device test input, EXPFAULT1.
			16	Input configured as Bar safety, tested safety edge. Input 3 (EXPI2) on input/output expansion board is switched automatically to safety device test input, EXPFAULT1.
			17	Input configured as safety Bar OP test, safety edge with inversion active only while opening, if while closing the movement stops. Input 3 (EXPI2) on input/output expansion board is switched automatically to safety device test input, EXPFAULT1.
18	Input configured as safety Bar CL test, safety edge with inversion active only while closing, if while opening the movement stops. Input 3 (EXPI2) on input/output expansion board is switched automatically to safety device test input, EXPFAULT1.			
EXP12	Configuration of EXP12 input on input-output expansion board. 1-3	0	0	Input configured as Start E command.
			1	Input configured as Start I command.
			2	Input configured as Open command.
			3	Input configured as Close command.
			4	Input configured as Ped command.
			5	Input configured as Timer command.
			6	Input configured as Timer Pedestrian command.
			7	Input configured as Phot (photocell) safety.
			8	Input configured as Phot op safety (photocell active during opening only).
			9	Input configured as Phot cl safety (photocell active during closing only).
			10	Input configured as Bar safety (safety edge).
			11	Input configured as safety Bar OP, safety edge with inversion active only while opening, if while closing the movement stops.
12	Input configured as safety Bar CL, safety edge with inversion active only while closing, if while opening the movement stops.			
EXP01	Configuration of EXP01 output on input-output expansion board 4-5	11	0	Output configured as 2 nd Radio Channel.
			1	Output configured as SCA (gate open light).
			2	Output configured as Courtesy Light command.
			3	Output configured as Zone Light command.
EXP02	Configuration of EXP02 output on input-output expansion board 6-7	11	4	Output configured as Stair Light.
			5	Output configured as Alarm.
			6	Output configured as Flashing light.
			7	Output configured as Latch.
			8	Output configured as Magnetic lock.
EXP02	Configuration of EXP02 output on input-output expansion board 6-7	11	9	Output configured as Traffic Light control with TLB board.
			10	Output configured as Flashing Light and Maintenance.
			11	Output configured as Traffic Light control with TLB board.
TRAFFIC LIGHT PREFLASHING	Traffic light pre-flashing	0	0	Pre-flashing switched off.
			1	Red lights flash, for 3 seconds, at start of operation.
TRAFFIC LIGHT RED LAMP ALWAYS ON	Steadily lit red light	0	0	Red lights off when gate closed.
			1	Red lights on when gate closed.

INSTALLATION MANUAL

TABLE "C" – RADIO MENU (rRad la)

Logic	Description
<i>Add Start</i>	Add Start Key associates the desired key with the Start command
<i>Add 2ch</i>	Add 2ch Key associates the desired key with the 2nd radio channel command. Associates the desired key with the 2nd radio channel command. If no output is configured as 2nd Radio Channel Output, the 2nd radio channel controls the pedestrian opening.
<i>ErASE 64</i>	Erase List  WARNING! Erases all memorized transmitters from the receiver's memory.
<i>cod rH</i>	Read receiver code Displays receiver code required for cloning transmitters.
<i>Wk</i>	ON = Enables remote programming of cards via a previously memorized W LINK transmitter. It remains enabled for 3 minutes from the time the W LINK transmitter is last pressed. OFF = W LINK programming disabled.

D814123 0AA00_01

BFT Spa www.bft-automation.com
Via Lago di Vico, 44 **ITALY**
36015 Schio (VI)
T +39 0445 69 65 11
F +39 0445 69 65 22



SPAIN www.bftautomatismos.com
BFT GROUP ITALIBERICA DE AUTOMATISMOS S.L.
08401 Granollers - (Barcelona)

FRANCE www.bft-france.com
AUTOMATISMES BFT FRANCE
69800 Saint Priest

GERMANY www.bft-torantriebe.de
BFT TORANTRIEBSSYSTEME GmbH
90522 Oberasbach

BENELUX www.bftbenelux.be
BFT BENELUX SA
1400 Nivelles

UNITED KINGDOM www.bft.co.uk
- **BFT Automation UK Limited**
Unit C2-C3, The Embankment Business Park, Vale Road, Heaton Mersey, Stockport, SK4 3GL

- **BFT Automation (South) Limited**
Enterprise House, Murdock Road, Dorcan, Swindon, SN3 5HY

PORTUGAL www.bftportugal.com
BFT SA - COMERCIO DE AUTOMATISMOS E MATERIAL DE SEGURANCIA
3026-901 Coimbra

POLAND www.bft.pl
BFT POLSKA SP.ZO.O.
Marecka 49, 05-220 Zielonka

IRELAND www.bftautomation.ie
BFT AUTOMATION LTD
Unit D3, City Link Business Park, Old Naas Road, Dublin 12

CROATIA www.bft.hr
BFT ADRIA D.O.O.
51218 Drazice (Rijeka)

CZECH REPUBLIC www.bft.it
BFT CZ S.R.O.
Praha

TURKEY www.bftotomasyon.com.tr
BFT OTOMATIK KAPI SISTEMELERI SANAY VE
Istanbul

RUSSIA www.bftrus.ru
BFT RUSSIA
111020 Moscow

AUSTRALIA www.bftaustralia.com.au
BFT AUTOMATION AUSTRALIA PTY LTD
Wetherill Park (Sydney)

U.S.A. www.bft-usa.com
BFT USA
Boca Raton

CHINA www.bft-china.cn
BFT CHINA
Shanghai 200072

UAE www.bftme.ae
BFT Middle East FZCO
Dubai