

Nice Apollo 1050 Control Board

Vehicular Gate Control Board

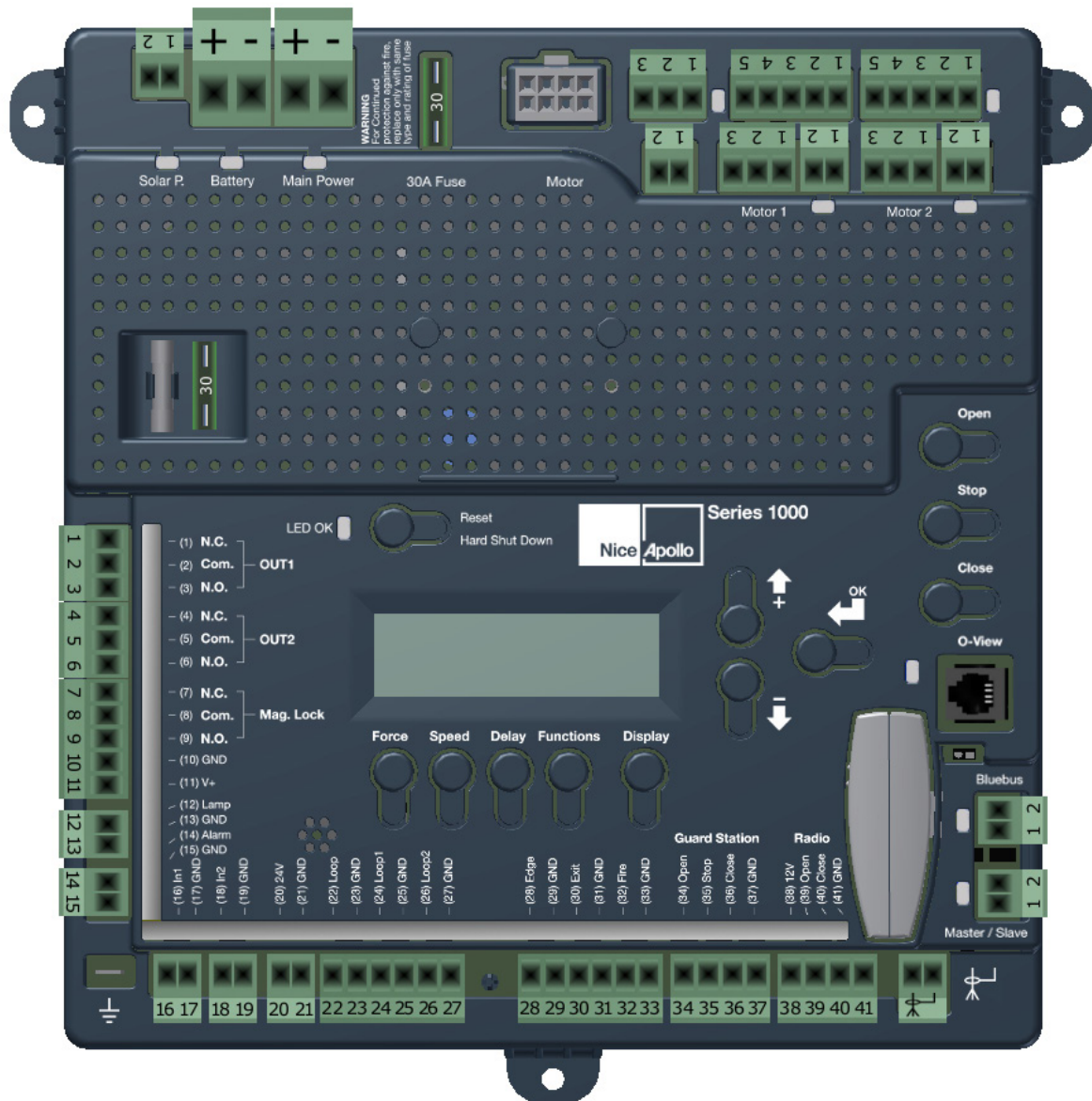

TABLE OF CONTENTS

CAUTIONS AND NOTES	4
EXTREMELY IMPORTANT	4
ETL DEFINITIONS COMPLIANT TO UL325	4
1 - OVERVIEW	4
1.1 - Main control board	4
1.2 - Main control board specifics	4
2 - GATE INFORMATION	4
2.1 - ASTM F2200	4
2.2 - Gate latches	5
2.3 - Specific applications	5
2.4 - Swing gates	5
2.5 - General requirements	5
3 - SAFETY AND CAUTIONS	5
3.1 - Properly installed safety devices	5
3.2 - Safety signs, notices to personnel warning signs	5
3.3 - Gate system safety devices	6
3.4 - Infrared beams and warning signs	6
3.5 - Establish the location	6
3.6 - Read and follow all instructions	6
3.7 - Keep children away	6
3.8 - Test the gate system	6
3.9 - Keep gates properly maintained	6
4 - INSTALLATION NOTES	
4.1 - Follow Instructions	6
4.2 - Intended usage	6
4.3 - Warnings, cautions and notes	6
5 - CIRCUIT BOARD LAYOUT	7
5.1 - Circuit board layout	7
5.2 - 1050RK retrofit kit bracket layout	7
6 - WIRING	9
6.1 - Power input connections	9
6.2 - 416 / 816 Actuator wiring (Standard)	10
6.3 - 416 / 816 Actuator wiring (Push to open)	10
6.4 - T5, T7, H12, M12 Wiring (Standard)	11
6.5 - T5, T7, H12, M12 Wiring (Push to open)	11
6.6 - 3500 / 3600 Wiring (Left hinged gate)	12
6.7 - 3500 / 3600 Wiring (Right hinged gate)	12
6.8 - 7200 Wiring	13
6.9 - 7300 Wiring	14
6.10 - Limit and motor connections to the board	15

7 - SETTING LIMIT SWITCHES	15
8 - LEARNING MODE	16
9 - ACCESSORY INPUTS AND OUTPUTS	17
9.1 - Outputs	17
9.2 - Inputs	17
9.3 - Communication buses	18
9.4 - Programming the plug-in receiver and remote controls	18
10 - 120VAC POWER AND SOLAR PANEL CHART	19
10.1 - 120VAC Power	19
10.2 - Solar panel chart	19
11 - OPTIONAL INPUTS	20
11.1 - Fire dept. connection	20
11.2 - Magnetic lock connection	20
11.3 - Guard station	20
11.4 - Exit and edge inputs wiring diagram	20
11.5 - Radio receiver connection (third party)	21
11.6 - Optional power output	21
12 - INSPECTION AND OPERATION	21
13 - GENERAL LAYOUT AND SAFETY ACCESS	22
13.1 - Swing gate	22
13.2 - Slide gate	23
14 - ACCESSORIES AND SENSORS	24
15 - BOARD NOMENCLATURE	25
16 - PROGRAMMING BUTTONS	26
16.1 - Force	26
16.2 - Speed	26
16.3 - Acceleration	26
16.4 - Delay	26
16.5 - Function	26
16.6 - Display	27
17 - EMERGENCY VEHICLE ACCESS	28
18 - GLOSSARY	29
19 - MAINTENANCE SCHEDULE	29
20 - TROUBLESHOOTING	29
21 - INSTALLATION CHECKLIST	30

CAUTIONS AND NOTES

This instruction manual is intended to aid the installer in the overall process of correct installation at the desired location. Periodically, the manual will illustrate "warnings, cautions and notes" which are items the installer should carefully read to prevent damage to the gate, gate system or personal injury to yourself or others.

EXTREMELY IMPORTANT

Anyone who installs, assists with installation or otherwise facilitates the installation in any manner should thoroughly read and understand this manual in its entirety before any attempt is made to actually begin the installation process.

ETL DEFINITIONS COMPLIANT TO UL325

- Vehicular Slide-Gate Operator (or system) - A vehicular gate operator (or system) that controls a gate which slides in a horizontal direction that is intended for use for vehicular entrance or exit to a drive, parking lot, or the like.
- Gate - A moving barrier such as a Swinging, sliding, raising, lowering, rolling, or like barrier that is a stand-alone passage barrier or is that portion of a wall or fence system that controls entrance and/or egress by persons or vehicles and completes the perimeter of a defined area.
- Residential Vehicular Gate Operator - Class I - A vehicular gate operator (or system) intended for use in a home of one to four single family dwellings, or a garage or parking area associated therewith.
- Commercial / General Access Vehicular Gate Operator - Class II - A vehicular gate operator (or system) intended for use in a commercial location or building such as a multi-family housing unit (five or more single family units), hotel, garages, retail store, or other buildings servicing the general public.
- Commercial / General Access Vehicular Gate Operator - Class III - A vehicular gate operator (or system) intended for use in an industrial location, loading dock area, or other location not intended to service the general public.
- Commercial / General Access Vehicular Gate Operator - Class IV - A vehicular gate operator (or system) intended for use in a guarded industrial location or buildings such as airport security area or other restricted access locations not servicing the general public, in which unauthorized access is prevented via supervision by security personnel.

1 - OVERVIEW

This manual provides documentation that covers the layout, electrical installation, and programming of the Apollo 1050 gate controller for a typical installation. Please consult your Apollo distributor for more information regarding installations or questions not specifically covered in this manual.



**DO NOT CONNECT
A/C POWER TO THIS
CIRCUIT BOARD!**

This circuit board is designed for
10VDC - 35VDC power input only.

1.1 - 1050 control board

The 1050 main control board is housed in a protective plastic enclosure that includes a 2-line LCD and with 5 dedicated buttons and 3 buttons for navigation of the setup, programming, and information menus. Connectors for power, inputs, and output peripherals are arranged around the edges of the board and clearly labeled. A plug-in connector is provided for direct installation of a Nice-brand receiver which can be controlled by up to 1000 transmitters. A reset RJ-11 jack offers a connection to an optional O-view programmer with Bluetooth and GSM which can be used to control the gate with a telephone, smartphone, or PC. Connectors for other Nice-brand plug in accessories include 2-wire Bluebus, self-monitored photocells for entrapment protection. Dry contact inputs are provided for loop, probe, and photoelectric detectors, as well as edge sensors, guard station, and fire department control of gate opening and closing. Voltage outputs (+12VDC and +24VDC) are also made available to power safety and entrapment-prevention devices, and a magnetic lock if required. On board charge control circuitry delivers reliable power to a backup battery (if installed) and the unit is equipped with input for a solar panel for self-powered installations.

The 1050 main control board accepts DC input voltage ranging from 10VDC to 35VDC. A 2-line LCD with dedicated buttons allows the installer to quickly program the 1050 when changes to its factory-default settings need to be made. A real time clock/calendar enables programming for scheduled weekly or daily events like opening, closing, or locking the gate. Gate opening and closing speed, acceleration, soft-start settings, and reversing speed may be set to factory default settings, or individually programmed per customized gate installation requirements. Built-in current sensing enables inherent gate force monitoring and limiting for safety and an on board alarm indicates when two sequential obstructions have been sensed in either direction. The "Learn" function helps the gate installer configure the Apollo 1050 control board semi-automatically for optimum settings of gate opening and closing speeds, with simple programmable adjustments to force and speed settings that may be made with front panel programming.

1.2 - Main control board specifics

- Inputs for solar panel and batteries.
- Low power consumption in stand-by mode.
- Built-in regulator to keep the battery charged (either through solar or main power).
- Socket for plug-in Nice receivers.
- Board compatible with Nice Opera System (facilitates programming and diagnostic's away from the site of installation).
- Easy programming with LCD display and dedicated buttons.
- Digital programming for auto-close, force, speed, opening delay.
- On board buttons for operating the gate (Open, Close, Stop).
- Built-in voltmeter to check input voltage, battery voltage, solar panel voltage, motors' current.
- Temperature sensor to optimize charging battery and system performance.
- Programmable service alarm.
- 2 Programmable timers (from 1 sec to 9 hours).
- Inputs for guard station, additional third party receivers, loop detectors, FIRE and UL/Edge signals.
- 2 programmable inputs (open, close, step, mid-position, hold to open, hold to close, activating timer).
- Surge suppression on every peripheral input (digital and analog).
- Ports for self-powered Nice plug-in peripherals. (BlueBus).

2 - GATE INFORMATION

2.1 - ASTM F2200

Gates shall be constructed in accordance with the provisions given for the appropriate gate type listed, refer to ASTM F2200 for additional gate types. Protrusions shall not be permitted on any gate, refer to ASTM F2200 for exceptions if any.

Any non-automated gate that is to be automated in any manner should be upgraded to conform to the provisions contained within the provisions of this document and ASTM F2200 as applicable.

2.2 - Gate latches

In association with this gate controller and these operators, at no time should manual gate latches or locks be used. The forces applied to an operator could be in excess of those forces which are safe for bystanders. Should unnecessary forces be applied to a gate system which is in the locked position, the catastrophic failure of the gate or locking mechanism could result in substantial damage, extensive physical injury and or death.

2.3 - Specific applications

This gate operators are intended for those locations where vehicle traffic is intended to be controlled through the use of an entryway obstruction (gate). The gate system should be made of closed material types which prevent any body part from entering, becoming entangled or otherwise entering the gate in any manner. If the gate is not fully closed off from access, the opening or closing of the gate system may result in severe damage, injury or death.

2.4 - Swing and slide gates

Swing and slide gates are designed to move across an entry control point to prevent or allow controlled access by authorized persons or equipment. Swing or slide gate systems are not necessarily completely autonomous systems, and require regular maintenance and inspection on a periodic schedule. Although with certain safety devices in place the gate system could operate as a completely independent system free from human interaction for a defined period of time, human inspection and testing is required to ensure longevity and safe operation over long periods of time.

2.5 - General requirements

- Safety and security are obviously a number one priority for both the manufacturer and the end user. As a result this manual has been written to make all persons fully aware of the responsibilities required to ensure constant safety, security and longevity are acquired throughout the life of the system.
- The manufacturer of this swing gate system has performed countless hours of testing, analysis and statistical control analysis to ensure that this operator performs its intended function for extended periods of time. The installer should ensure and verify that all required safety devices are installed correctly and in a manner consistent with the requirements of this manual. Additionally, all devices, security devices, safety devices, sensors and other affiliated attachments are installed in a robust manner that will prevent their accidental damage, removal or incidental tampering.
- A basic requirement for this system to operate correctly is that at any time a sensor is triggered, covered, disconnected or otherwise tampered with, that the entire system ceases to function. If any part of the gate safety system is removed or triggered, an immediate safety action by the gate operator is expected (retraction or stoppage). If the gate safety system is not functional, or fails to operate within these guidelines, the gate should be immediately removed from service until repairs can be made.
- Any gate system that is open or has slats, bars or other material which allows an individual to stick their hands, head, or feet through the material, must be converted or covered in such a manner so as to prevent such future actions. Application of materials, and how to modify the gate system is up to the end user or installer, however care should be taken to prevent such human interaction into the moving gate system. No entry into the gate is ever authorized and should be prevented by whatever measures are required for that specific installation. Care should always be used during installation!
- Loops and loop detectors, photo-cells or other equivalent devices must be installed with this gate operator to prevent the gate from closing on vehicular traffic
- The speed limit for vehicular traffic through the gate area is 5 MPH. Install speed bumps and signs to keep vehicular traffic from speeding through the gate area. Failure to adhere to posted speed limits can result in damage to the gate, gate operator, and to the vehicle.
- Be sure that all residents are familiar with the proper use of the gate and gate operator. Be sure that all residents are familiar with the possible hazards associated with the gate system.
- Be sure that all warning signs are permanently installed on both sides of the gate in an area where they are fully visible to traffic
- It is your responsibility to periodically check all reversing devices. If any of these devices are observed to function improperly, remove the operator from service immediately and contact your installing or servicing dealer.

- Follow the recommended maintenance schedule of one inspection per every 180 days of use.
- Do not allow children to play in the area of the operator or to play with any gate-operating device.
- Be sure that all activating devices are installed a minimum distance of 8 feet away from the gate and gate operator, or in such a way that a person cannot touch the gate or gate operator while using the activating device. If activating devices are installed in violation of these restrictions, immediately remove the gate operator from service and contact your installing dealer.
- To remove the gate operator from service, operate the gate to the full open position, shut off power to the operator at the service panel, and disconnect batteries.



AUTOMATIC GATES ARE NOT FOR PEDESTRIANS!



Automatic gate openers are designed for vehicular traffic. They are powerful and can cause serious bodily injury or death. Accordingly, direct all pedestrian traffic to a separate walk-through gate.

3 - SAFETY AND CAUTIONS



WARNING

IMPORTANT SAFETY INSTRUCTIONS

WARNING - TO REDUCE THE RISK OF INJURY OR DEATH READ AND FOLLOW ALL INSTRUCTIONS.

- Never let children operate or play with gate controls. Keep the remote control away from children.
- Always keep people and objects away from gate. **NO ONE SHOULD CROSS THE PATH OF THE MOVING GATE.**
- Test the operator periodically. The gate **MUST** reverse on contact with a rigid object or stop or reverse when an object activates the non-contact sensors. After adjusting the force or the limit of travel, retest the gate operator. Failure to adjust and retest the gate operator properly can increase the risk of injury or death.
- Use the emergency release only when the gate is not moving.
- **KEEP GATES PROPERLY MAINTAINED.** Read the owner's manual. Have a qualified service person make repairs to gate hardware.
- The entrance is for vehicles only. Pedestrians must use separate entrance.
- **SAVE THESE INSTRUCTIONS!**

3.1 - Properly installed safety devices

Safety devices are used to sense, register and prevent damage to vehicular traffic which may block the path of the gate system. If properly installed and inspected for functionality within the prescribed maintenance procedures, the safety devices should prevent the gate system from inflicting harm or damage as a result of its opening and closing action.

3.2 - Safety signs, notices to personnel warning signs

Safety devices must alert all who may enter the gate system area, as to the danger posed by moving equipment. Safety features must be installed and work correctly, such as the infrared beam. This safety device prevents serious injury or death as a result of the gate closing while an object or person blocks the gate operating pathway. An optional flashing lamp that is activated any-time the gate is moving should be added in addition to the aforementioned safety features.

3.3 - Gate system safety devices

Automatic gate operators are designed to move a heavy steel gate. Great amounts of force are sometimes used to move these heavy systems. The automatic gate system may cause significant damage or injury if the path of the gate is obstructed. All sensors, safety devices and warning notices must be in place and operable in order for this system to operate properly. It is the installer's responsibility to install this system properly and to ensure its correct and safe operation.

3.4 - Infrared beams and warning signs

Infrared beams are used to inform the control board that an obstruction is present. Safety devices must be installed properly and inspected periodically to ensure continued reliability and safety. Safety devices, safety sensors, warning signs and notices of moving equipment danger must be installed and readily visible by all paths of approach to the gate system. Failure to post warnings could result in loss of life, damage or physical injury.

3.5 - Establish the location

The installer of this system needs to establish the location of the opener in accordance with instructions contained within this manual. A typical layout is provided at the end of this manual with a nominal basic drawing. It is the installer's responsibility to ensure that the opener is installed in such a fashion so as to prevent binding, pinching or improper articulation of the system throughout its actuation cycle.

3.6 - Read and follow all instructions

3.7 - Keep children away

Never let children operate or play with gate controls. Keep the remote control away from children.

3.8 - Test the gate system

The gate must reverse on contact with a rigid object or stop when an object activates the non-contact sensors. After adjusting the force or the limit of travel, retest the gate operator. Failure to adjust and retest the gate operator properly can increase the risk of injury or death. Test force and correct functionality for photo-eyes and other safety devices at least every 6 months. ONLY USE the MANUAL RELEASE when the gate is not moving or when the unit fails or in case of power outage.

- Turn the power to the gate controller OFF AND REMOVE BATTERIES before using the emergency release.

3.9 - Keep gates properly maintained

Have only a qualified service person make repairs. Unqualified service technicians are not recommended.

4 - INSTALLATION NOTES

Before installing and/or operating the gate opener, installers and/or users should do the following:

- Confirm the gate operator being installed is appropriate for the application.
- Confirm the gate is designed and built according to current applicable published industry standards.
- Confirm all appropriate features and accessory devices are being incorporated, including both primary and secondary entrapment protection devices.
- Make sure the gate works freely before installing the operator.
- Repair or service worn or damaged gate hardware before installing the operator.
- Adjust the FORCE device to the minimum force setting that allows reliable gate operation.
- Install operator inside fence line (DO NOT install operator on public side of fence line).
- Swinging gates shall not open into public access areas.
- Install a proper electrical ground to a gate operator.
- Install keypad controls where users cannot touch, or reach through gate while operating controls, which is a minimum of 8 feet from the gate.
- Install controls where user has full view of gate operation.
- Install all warning signs (In accordance with UL 325) on both sides of the gate to warn persons in the area of potential hazards associated with the automatic vehicular gate operation.

- A minimum of two (2) WARNING SIGNS shall be installed, one on each side of the gate where easily visible.
- Test all features for proper functions before placing the automatic vehicular gate opener into service.
- Demonstrate the basic functions and safety features of the gate system to owners/end users/general contractors, including how to turn off power and how to operate the manual release feature.
- Leave safety instructions, product literature, installation manual and maintenance instructions with end user.
- Explain to the owners/users the importance of a service contract that includes a routine testing of the entire system including the entrapment protection devices, and explain the need for the owners to insure that this testing is performed routinely.
- Offer the owner/end user a maintenance contract, or contact them regularly to offer maintenance.
- See instructions on the placement of non contact sensors for each type of application.

4.1 - Follow Instructions

Always follow all instructions included in this manual to ensure safety and the longevity of the operator.

4.2 - Intended usage

THIS CIRCUIT BOARD IS INTENDED FOR USE WITH VEHICULAR SWING AND SLIDE GATES ONLY.

4.3 - Warnings, cautions and notes

- 4.3.1 Gate terms "system", "gate operator", "gate system", and "gate operator system" for these warnings, cautions, and notes is intended to cover the gate controller, gate controller software, the gate actuator, and all safety accessories included within a typical installation.
- 4.3.2 Gate system designers, installers and users must take into consideration the inherent hazards associated with each installation, since no two installations will be exactly alike.
- 4.3.3 Improperly designed, constructed, installed or maintained systems can and may introduce hazards which may or may not be readily seen or identified by users, bystanders, installers or inspectors
- 4.3.4 All pinch points must be guarded or eliminated.
- 4.3.5 Only install this gate system opener in appropriate manners in which the operation is safe and secure.
- 4.3.6 A gate operator exerts a great amount of force in order to move the gate system in normal operation, therefore appropriate safety sensors, measures, notices and appropriate safety features must be incorporated in all installations.
- 4.3.7 The gate must be installed correctly and no binding or resistance should be present throughout its movement in either direction.
- 4.3.8 The gate system must be installed in an area and in such a manner in which the gate has sufficient clearance to open, close and move without striking or contacting any structures and/or other obstructions.
- 4.3.9 The gate system is designed for vehicular traffic only, and should never, under any situation be used for pedestrian traffic
- 4.3.10 Pedestrian prohibited signs, warning signs or other suitable measures must be used at minimum, to warn pedestrians to stay away from, and to not use this system under any circumstances.
- 4.3.11 Pedestrians should be encouraged to use a pedestrian entry/exit only.
- 4.3.12 Pedestrians should never cross the path of a moving gate. The sensors are designed to prevent contact with a vehicle and are not necessarily capable of preventing contact with a pedestrian. Care should be taken to prevent pedestrian usage under any circumstances.
- 4.3.13 One or more non-contact sensors must be used in any situation or area where entrapment may have the possibility of occurring.
- 4.3.14 Gates shall be constructed in accordance with the provisions given for the appropriate gate type listed, refer to ASTM F2200 for additional gate types.
- 4.3.15 Any existing manual gate latches shall be removed or disabled when an automatic gate system is installed. Use only mag-locks controlled by the system.

- 4.3.16 Protrusions shall not be permitted on any gate, refer to ASTM F2200 for exceptions, if any.
- 4.3.17 Gates shall not be designed, constructed and installed in such a manner that gravity will cause or initiate movement in any direction whether the operator is attached or not.
- 4.3.18 A pedestrian gate shall not, under any circumstances, be attached to, or incorporated into, any vehicular gate system in manner. This also applies to any fence or wall, or any portion thereof, that the gate may cover in the open or closed position.
- 4.3.19 Any non automated gate that is to be automated in any manner should be upgraded to conform to the provisions contained within the provisions of this document and ASTM F2200 as applicable.
- 4.3.20 To reduce the risk of severe injury or death please read and understand this entire manual and your local code requirements prior to starting installation. Additionally, understanding the ASTM standards will assist you in the proper assembly, installation and operation of your gate opening system.
- 4.3.21 Disconnect all electricity and/or all sources of power before performing any maintenance.
- 4.3.22 To reduce the risks of fire or injury always contact the installer or distributor prior to performing any repairs or maintenance.
- 4.3.23 Never operate gate with obstructions present.
- 4.3.24 No one should ever cross the operative path of the gate.
- 4.3.25 Never let children play or linger in the vicinity of the gate or opener equipment.
- 4.3.26 Never operate the gate or the opener when the opener is not operating or adjusted correctly.
- 4.3.27 Never allow children to play with or manipulate gate controls. Keep all remotes away from children.
- 4.3.28 Only use the MANUAL RELEASE when gate is completely stationary. Untrained persons should never touch the gate or any releases if any are installed or applicable.
- 4.3.29 Test the gate operator periodically (once every 6 months minimum). Gate must reverse course or stop immediately upon contact with any source in its path. Gate must stop and reverse course at any time any object or other item crosses the path of the gate. Should the safety sensors not stop and/or reverse the gates travel, immediately investigate and repair the inoperative condition. Gate should not be used under any circumstances, if all sensors and safety devices are not performing to standards illustrated within this manual.
- 4.3.30 Gate should not be used if safety devices are not performing to all local, state and federal guidelines.
- 4.3.31 Replace fuse only with fuse of same type and rating.
- 4.3.32 Installation of this gate system in a manner inconsistent with the manufacturer's recommended instructions, local, State or Federal law transfers the liability unto the installer. Careful consideration has been taken by the manufacturer's to devise safe measures, safe design and incorporate safety measures to prevent injury, death or property damage. By circumventing, ignoring or modifying any safety system or the exclusion thereof, the installer is creating a new untested process outside the purview of the manufacturer and therefore assumes all risk.
- 4.3.33 This unit is not to be installed on any gate, door or other structure which serves to block, secure, close off or otherwise control a pedestrian entry point or access point.
- 4.3.34 Vehicular swing gates shall be designed, constructed and installed in accordance with security related parameters specific to the application in question, with absolute safety in all considerations.
- 4.3.35 Never mount any device that operates the gate opener where the user can reach around, over or through the gate to operate the controls. Controls should be mounted at minimum, 8 feet away from any moving part of the gate or gate system.
- 4.3.36 A hard wired control shall be located in such a manner so that electronic communication between the two is never interrupted or the wires damaged.
- 4.3.37 Any controls used to reset the device after obstruction/entrapment protection incidents should be located within view of the gate and should have safety features that prevent unauthorized use.
- 4.3.38 Never allow anyone to ride, hang on or otherwise touch the gate.
- 4.3.39 Safety sensors must be present at all times. The hard wired safety sensors must be arranged and installed in such a manner so that the communication between gate operator and sensor(s) are never interrupted or severed by mechanical damage or movement. All items which have sensors or safety devices installed must be constructed or installed in such a manner so as to prevent removal or damage. All subsequent sensors must be suitable for the system installed and approved for use.
- 4.3.40 Never increase the force used to move the gate, beyond the absolute minimum required.
- 4.3.41 Never use force adjustments to compensate for binding, sticking or resistant operation. These situations should be addressed and corrected before installation of the gate operator. Gate systems should swing freely in all directions prior to installation of this gate operator.
- 4.3.42 After any adjustment is made, all safety modes/features must be tested. Gate must stop or reverse upon any object crossing the path of the gate or the gate comes into contact with any object.
- 4.3.43 Activate gate only when the gate is in clear view of the user, the gate system is properly adjusted, tested and verified, and there are no obstructions present.
- 4.3.44 Keep gate and gate system properly maintained and properly inspected at all times.
- 4.3.45 This operator is intended for installation only on swing and slide gates used to control vehicular traffic.
- 4.3.46 The gate must be installed in a location so that sufficient clearance is provided between the gate and adjacent structures when opening and closing to reduce the risk of entrapment.
- 4.3.47 The gate must be properly installed and work freely in both directions prior to the installation of the gate operator.
- 4.3.48 Install the gate operator only when the operator is appropriate for the construction and the usage class of the gate.
- 4.3.49 The gate must be properly installed and work freely in both directions prior to the installation of the gate operator.
- 4.3.50 Controls must be far enough from the gate so that the user is prevented from coming in contact with the gate while operating the controls. Controls intended to be used to reset an operator after two sequential activations of the entrapment protection device(s) must be located in the line of sight of the outdoor gate or easily accessible controls shall have a security feature to prevent unauthorized use.
- 4.3.51 All warning signs and placards must be installed where visible in the area of the gate.
- 4.3.52 Care shall be given to reduce the risk of nuisance tripping such as when a vehicle trips the sensor while the gate is still moving.
- 4.3.53 Gate operators must utilize a contact sensor such as an edge sensor.
- 4.3.54 A hardwired contact sensor shall be located and its wiring arranged so that the communication between the sensor and the gate operator is not subject to mechanical damage.
- 4.3.55 A wireless contact sensor such as one that transmits radio frequency (RF) signals to the gate operator for entrapment protection functions are recommended.

5.1 - CIRCUIT BOARD LAYOUT

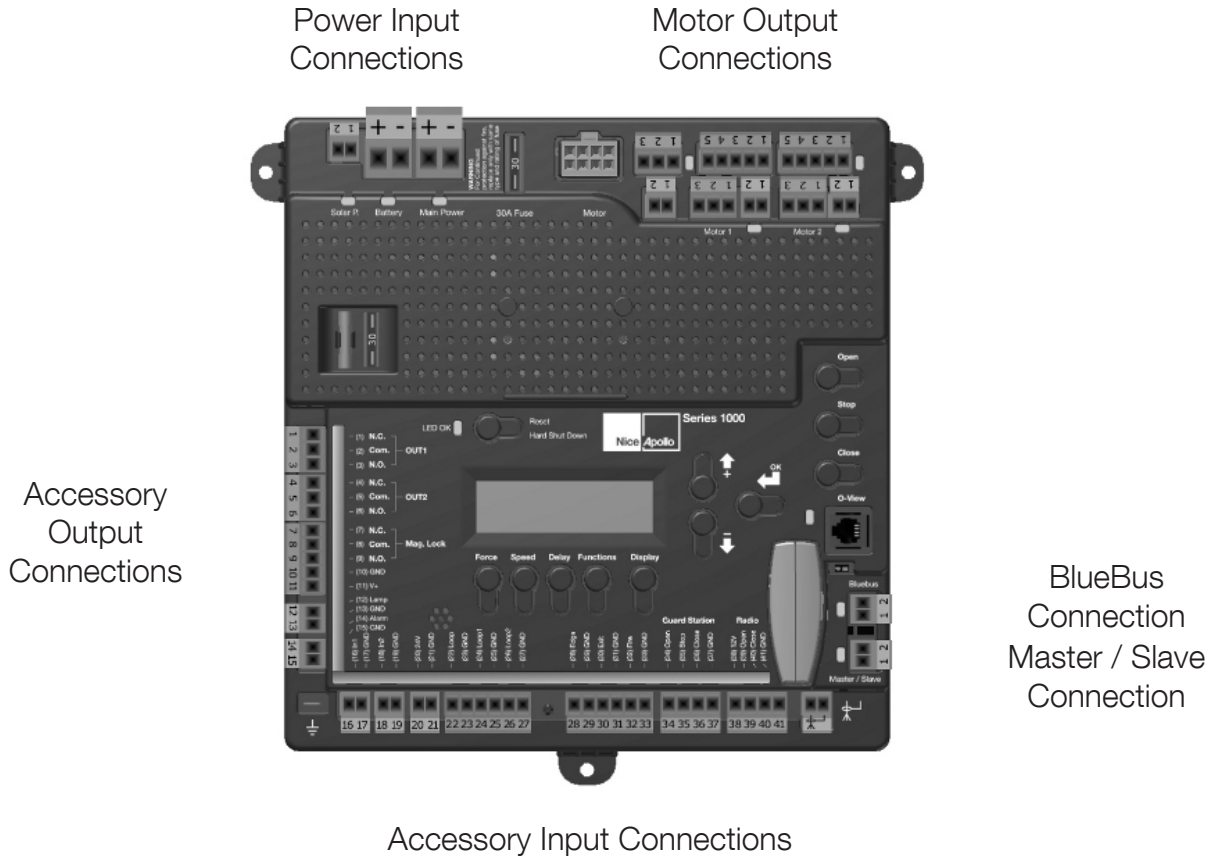

5.2 - 1050RK RETROFIT KIT BRACKET LAYOUT

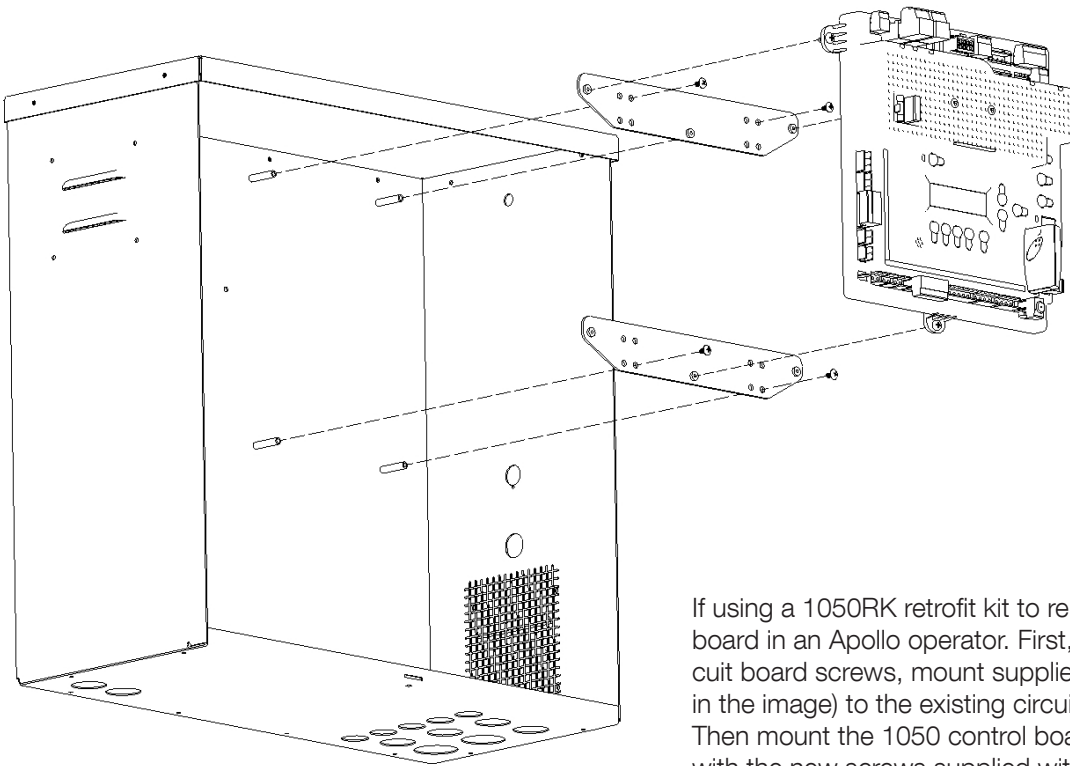

If using a 1050RK retrofit kit to replace an 835/836 board in an Apollo operator. First, using the existing circuit board screws, mount supplied brackets (as shown in the image) to the existing circuit board standoffs. Then mount the 1050 control board to the brackets with the new screws supplied with the 1050RK kit.

6 - WIRING

6.1 - Power input connections

Power input connections should be wired as follows:

Solar panel

Connect wires to the solar panel terminal block. The positive wire of the panel connects to the left terminal marked “+”.

Note: If the panel is connected backwards a red LED will illuminate below the terminal. If solar power is to be used it will be necessary to program control board for STANBY operation. See section 16 for information on STANBY mode.

Battery

Connect wires to the battery terminal block. The positive wire of the battery connects to the left terminal marked “+”.

Note: If the battery is connected backwards a red LED will illuminate below the terminal.

Main Power - This terminal block is for incoming 10-35VDC power only!

Connect wires to the main power terminal block. Positive of the power supply connects to the left terminal marked “+”. This input should only be used with a power supply capable of supplying 10-35VDC at 20 amps.

Note: If supply is connected backwards a red LED will illuminate below the terminal. If supply is connected properly a green LED will illuminate.

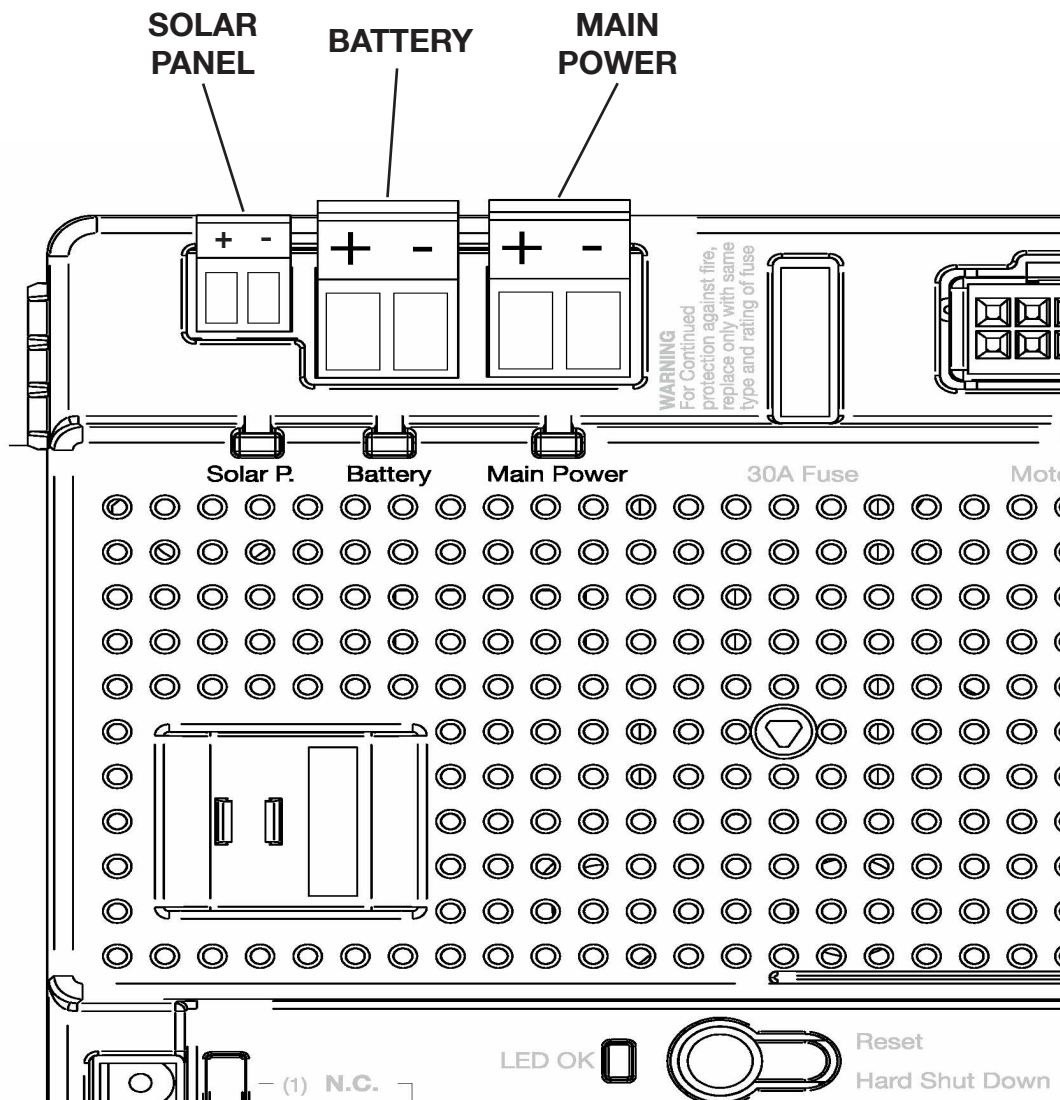

6.2 - 416 / 816 ACTUATOR WIRING (STANDARD)

416 limit switch wiring

Connect the Apollo 416 actuator cable to the 5-pin connector as shown below.

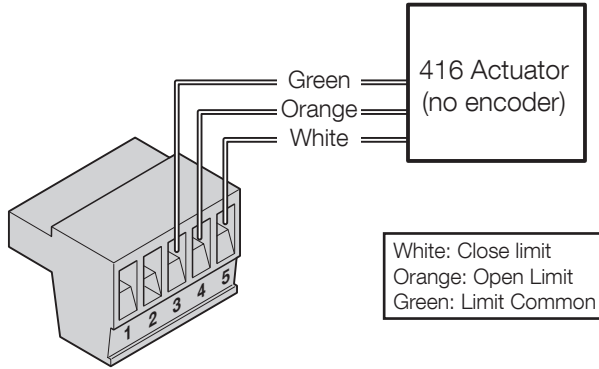

816 limit switch and smart sensor wiring

Connect the Apollo 816 actuator cable to the 5-pin connector as shown below. These connections enable the Apollo 816 limit switch and smart sensor inputs into the gate controller.

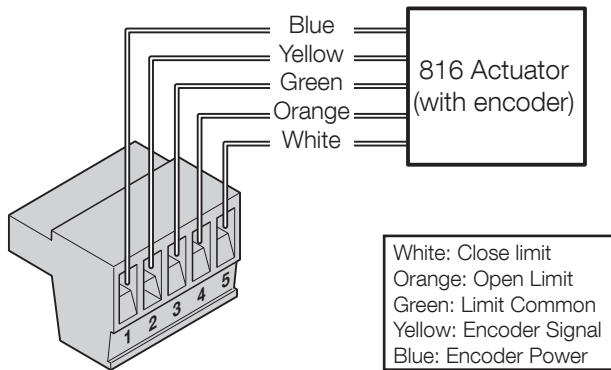

Apollo actuator motor wiring

Connect the Apollo 416/816 actuator motor leads to the 3-pin connector as shown below. **Note:** If the gate moves in the opposite direction from what is expected, reverse the actuator wiring from what is shown. (Red to Pin 3, Black to Pin 1).

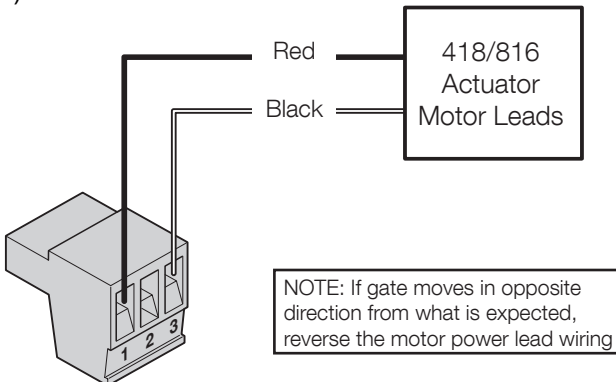

Install the 5 and 3-pin connector into the connection labeled "Motor 1" on the controller as shown in section 6.10. Install the 5 and 3-pin and connector into the connection labeled "Motor 2" for a dual leaf swing gate installation.

6.3 - 416 / 816 ACTUATOR WIRING (PUSH TO OPEN)

416 limit switch wiring

Connect the Apollo 416 actuator cable to the 5-pin connector as shown below.

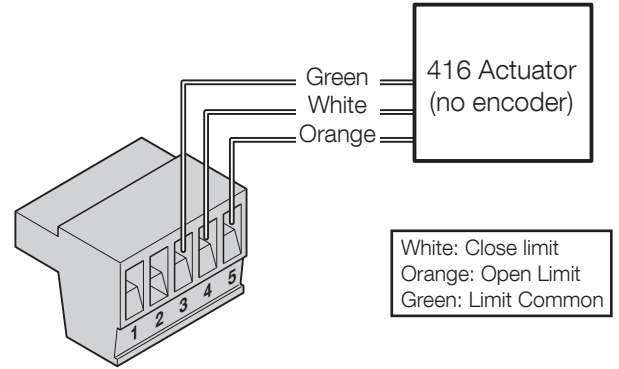

816 limit switch and smart sensor wiring

Connect the Apollo 816 actuator cable to the 5-pin connector as shown below. These connections enable the Apollo 816 limit switch and smart sensor inputs into the gate controller.

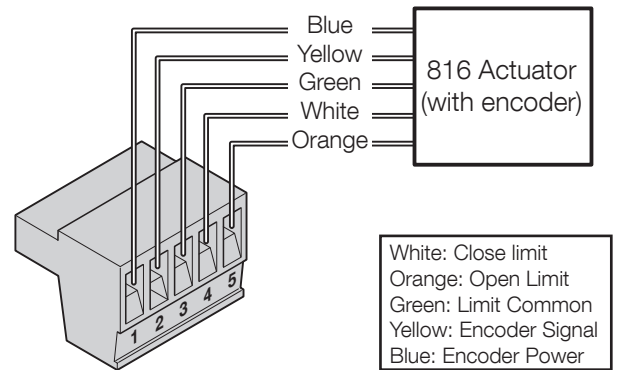

Apollo actuator motor wiring

Connect the Apollo 416/816 actuator motor leads to the 3-pin connector as shown below. **Note:** If the gate moves in the opposite direction from what is expected, reverse the actuator wiring from what is shown. (Red to Pin 1, Black to Pin 3).

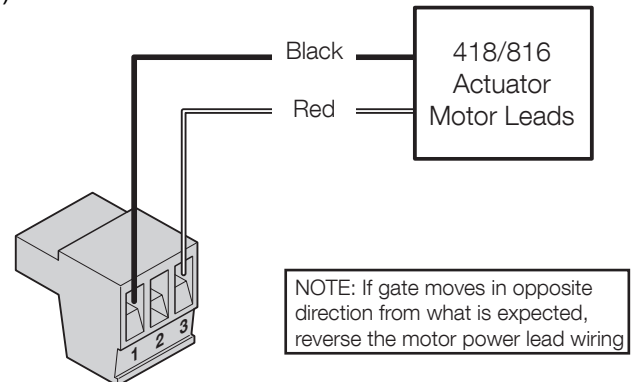

Install the 5 and 3-pin connector into the connection labeled "Motor 1" on the controller as shown in section 6.10. Install the 5 and 3-pin and connector into the connection labeled "Motor 2" for a dual leaf swing gate installation.

6.4 - T5/T7/H12/M12 WIRING (STANDARD)

Connect the T5/T7/H12/M12 cable to the 5-pin connector as shown below.

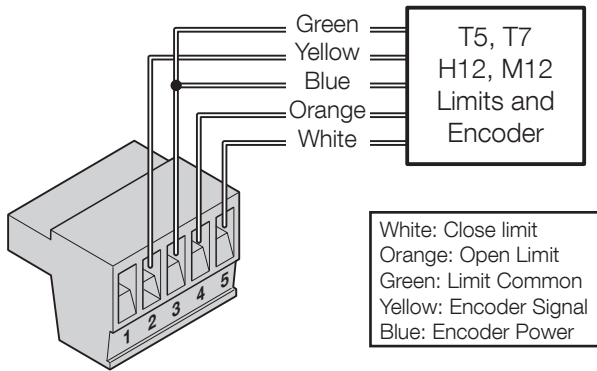

Connect the T5/T7/H12/M12 motor leads to the 3-pin connector as shown below. Note: If the gate moves in the opposite direction from what is expected, reverse the motor wiring from what is shown. (Red to Pin 3, Black to Pin 1).

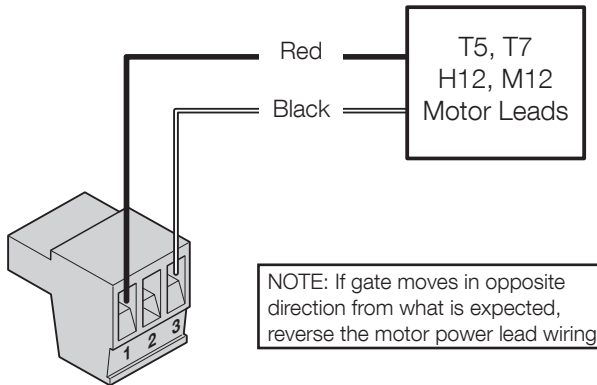

6.5 - T5/T7/H12/M12 WIRING (PUSH TO OPEN)

Connect the T5/T7/H12/M12 cable to the 5-pin connector as shown below.

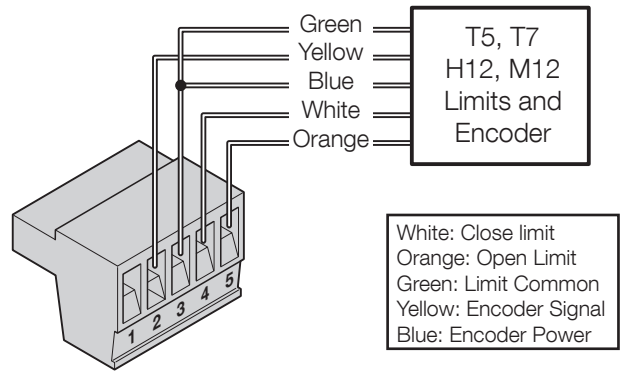

Connect the T5/T7/H12/M12 motor leads to the 3-pin connector as shown below. Note: If the gate moves in the opposite direction from what is expected, reverse the motor wiring from what is shown. (Red to Pin 1, Black to Pin 3).

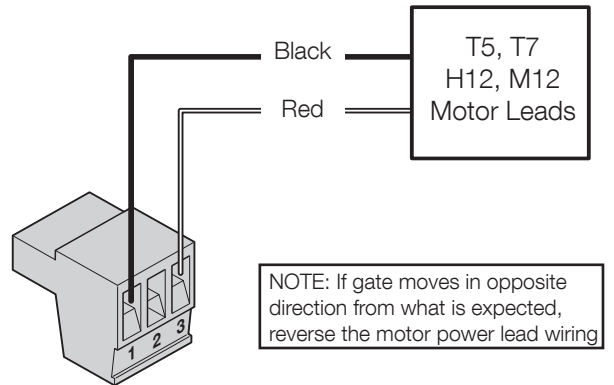

6.6 - 3500/3600 WIRING (LEFT HINGED GATE)

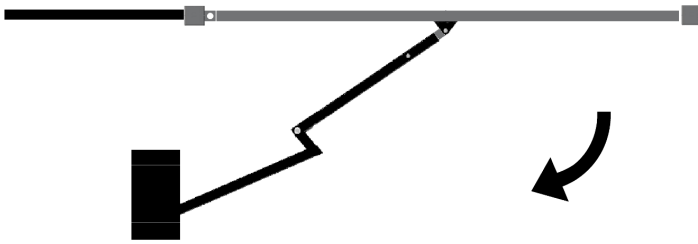

Limit switch wiring

Connect the 3500 cable to the 5-pin connector as shown below.

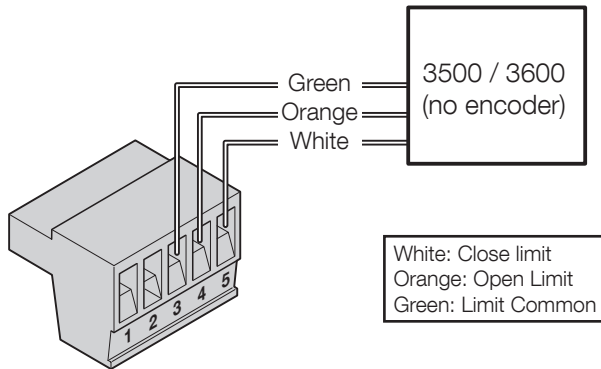

Motor wiring

Connect the motor leads to the 3-pin connector as shown below. Note: If the gate moves in the opposite direction from what is expected, reverse the actuator wiring from what is shown. (Red to Pin 3, Black to Pin 1).

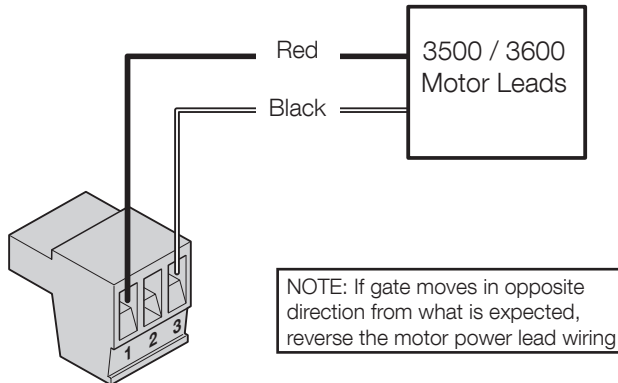

Install the 5 and 3-pin connector into the connection labeled "Motor 1" on the controller as shown in section 6.10. Install the 5 and 3-pin and connector into the connection labeled "Motor 2" for a dual leaf swing gate installation.

6.7 - 3500/3600 WIRING (RIGHT HINGED GATE)

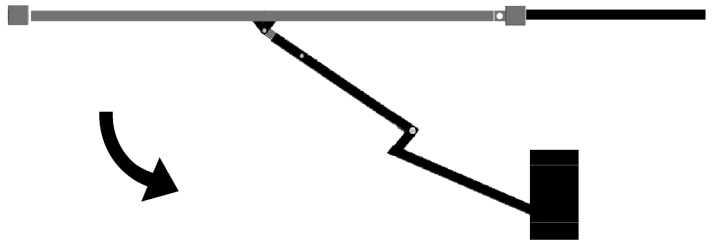

Limit switch wiring

Connect the 3500 cable to the 5-pin connector as shown below.

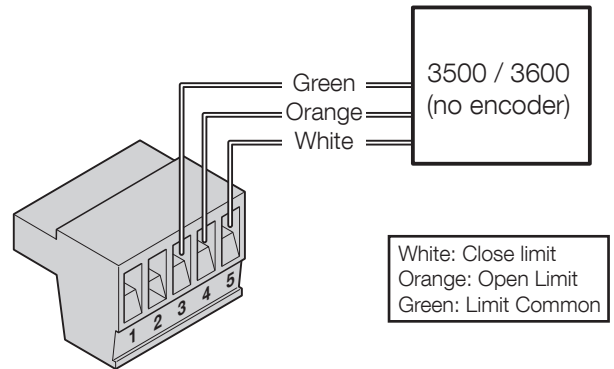

Motor wiring

Connect the motor leads to the 3-pin connector as shown below. Note: If the gate moves in the opposite direction from what is expected, reverse the actuator wiring from what is shown. (Red to Pin 1, Black to Pin 3).

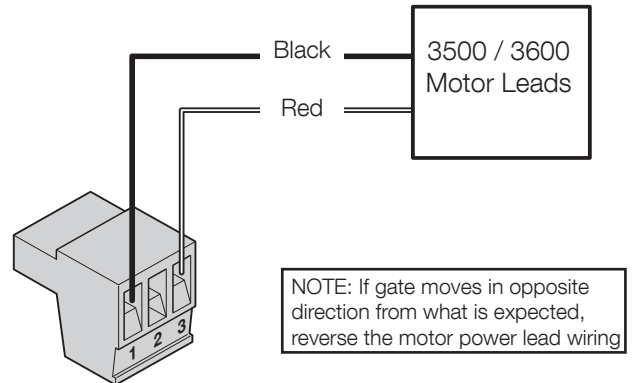

Install the 5 and 3-pin connector into the connection labeled "Motor 1" on the controller as shown in section 6.10. Install the 5 and 3-pin and connector into the connection labeled "Motor 2" for a dual leaf swing gate installation.

6.8 - 7200 WIRING (LEFT CLOSING GATE)

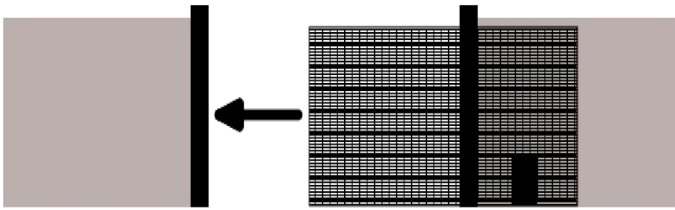

Limit switch wiring

Connect the 7200 cable to the 5-pin connector as shown below.

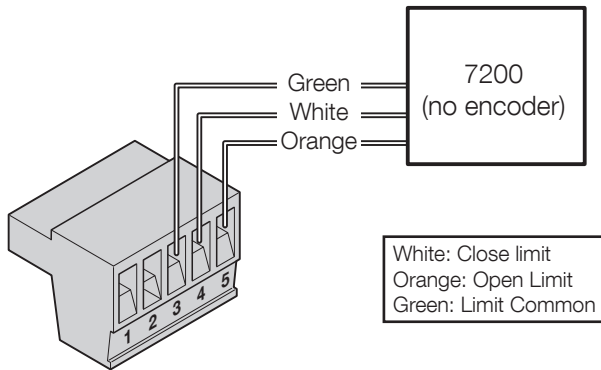

Motor wiring

Connect the motor leads to the 3-pin connector as shown below. **Note:** If the gate moves in the opposite direction from what is expected, reverse the actuator wiring from what is shown. (Red to Pin 3, Black to Pin 1).

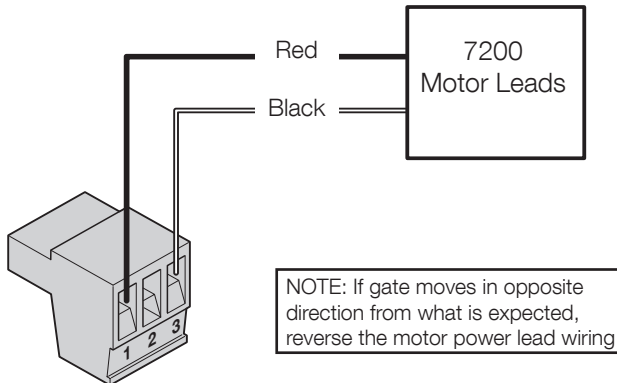

Install the 5 and 3-pin connector into the connection labeled "Motor 1" on the controller as shown in section 6.10. Install the 5 and 3-pin and connector into the connection labeled "Motor 2" for a dual leaf swing gate installation.

7200 WIRING (RIGHT CLOSING GATE)

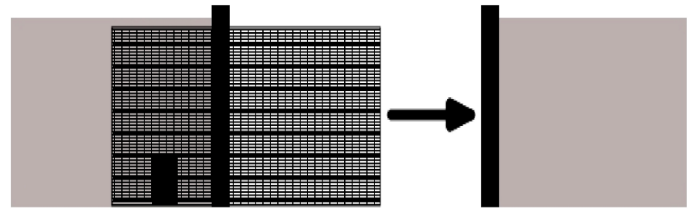

Limit switch wiring

Connect the 7200 cable to the 5-pin connector as shown below.

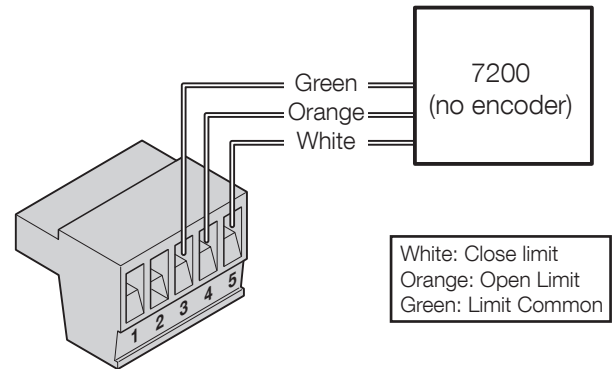

Motor wiring

Connect the motor leads to the 3-pin connector as shown below. **Note:** If the gate moves in the opposite direction from what is expected, reverse the actuator wiring from what is shown. (Red to Pin 1, Black to Pin 3).

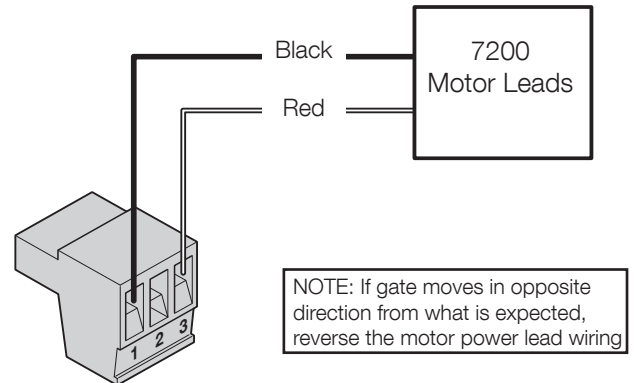

Install the 5 and 3-pin connector into the section labeled "Motor 1" on the controller as shown in section 6.10. Install the 5 and 3-pin and connector into the connection labeled "Motor 2" for a dual leaf swing gate installation.

6.9 - 7300 WIRING (LEFT CLOSING GATE)

7300 WIRING (RIGHT CLOSING GATE)

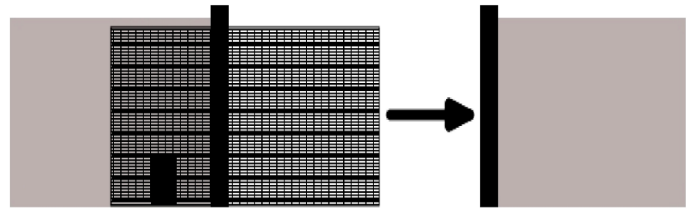
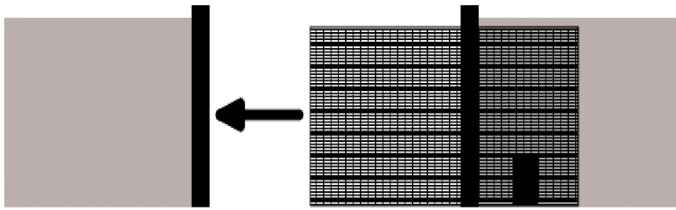

Limit switch wiring

Connect the 7300 cable to the 5-pin connector as shown below.

Limit switch wiring

Connect the 7300 cable to the 5-pin connector as shown below.

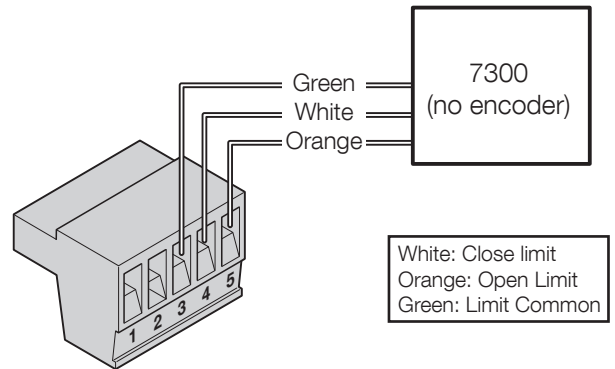
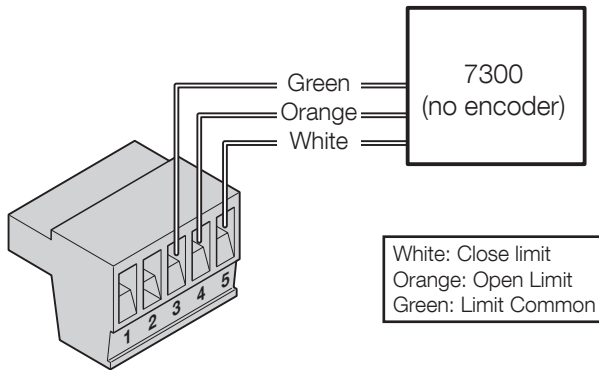

Motor wiring

Connect the motor leads to the 3-pin connector as shown below. Note: If the gate moves in the opposite direction from what is expected, reverse the actuator wiring from what is shown. (Red to Pin 1, Black to Pin 3).

Motor wiring

Connect the motor leads to the 3-pin connector as shown below. Note: If the gate moves in the opposite direction from what is expected, reverse the actuator wiring from what is shown. (Red to Pin 3, Black to Pin 1).

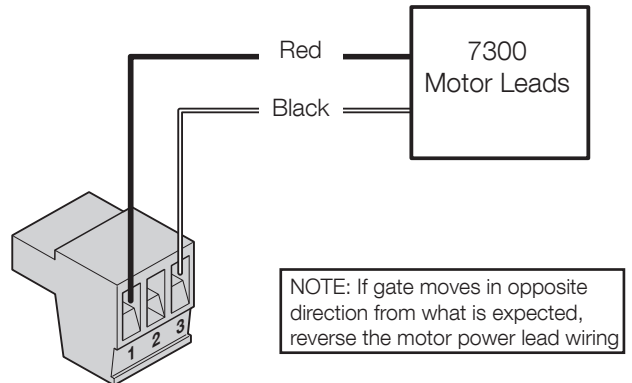
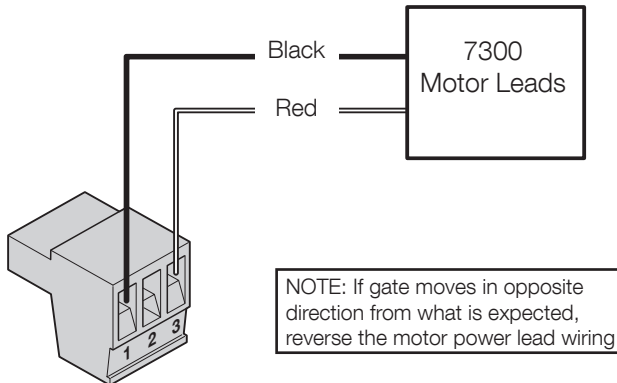

Install the 5 and 3-pin connector into the connection labeled "Motor 1" on the controller as shown in section 6.10. Install the 5 and 3-pin and connector into the connection labeled "Motor 2" for a dual leaf swing gate installation.

Install the 5 and 3-pin connector into the section labeled "Motor 1" on the controller as shown in section 6.10. Install the 5 and 3-pin and connector into the connection labeled "Motor 2" for a dual leaf swing gate installation.

6.10 - LIMIT AND MOTOR CONNECTION TO THE BOARD

Connect motor leads and limit wiring as shown below for Motor 1.

Motor 2 connections identical for dual leaf gate

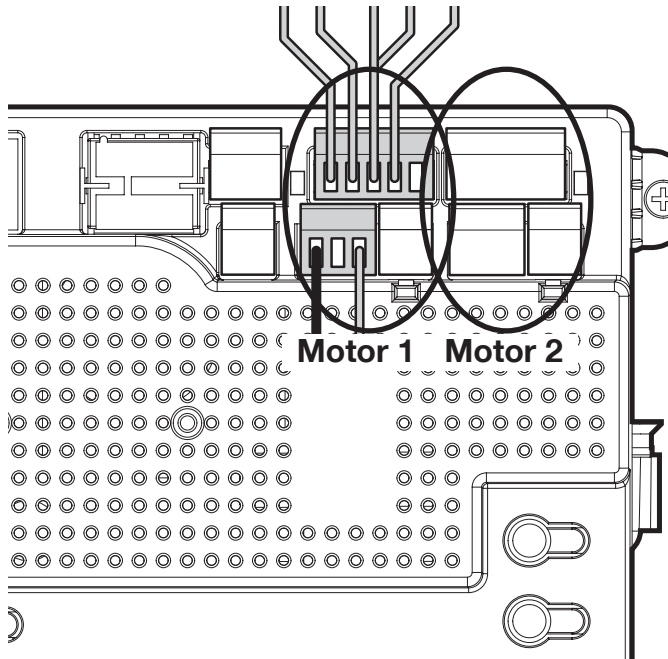

7 - SETTING THE LIMIT SWITCHES

The control board is already in the "LEARNING MODE" when shipped. If the board is not in "LEARN MODE" press **FUNCTION** then select **LEARN** then **SWING** then **LIGHT, AVERAGE OR HEAVY**, then press **ENTER**.

For dual gate installations - set one motor at a time.

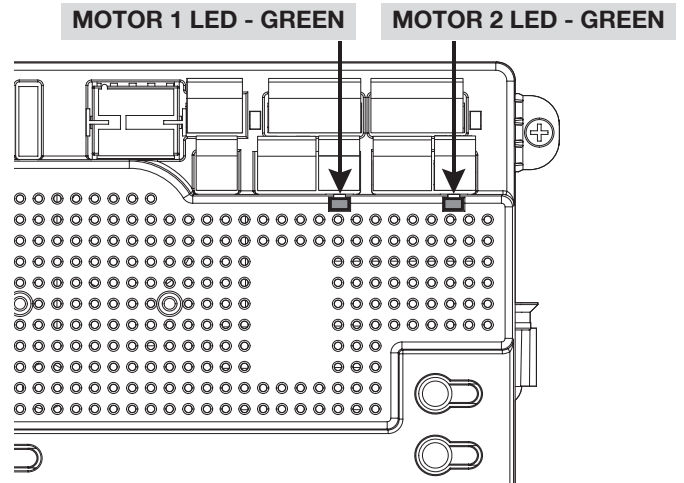

Green OPEN LED

1. Using the OPEN button on the front of the Control Board, hold the button down until the gate reaches the fully intended open position.
2. Adjust the Open Limit Switch on the operator until the GREEN light illuminates on the front of the control board as shown above. The fully OPEN limit switch is now set.

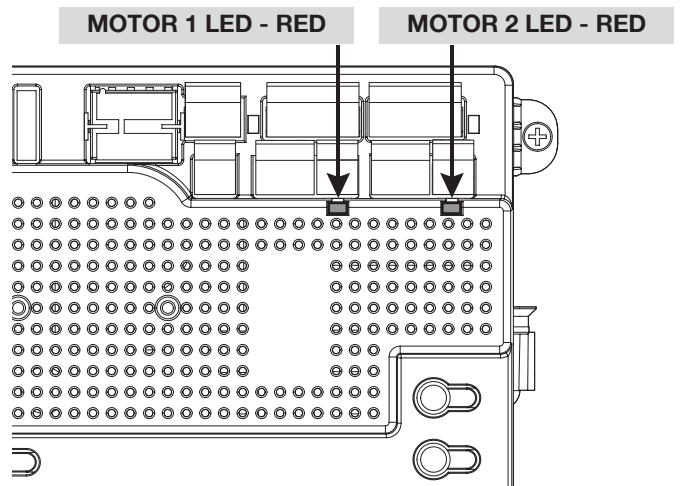

Red CLOSE LED

3. Using the CLOSE button on the front of the Control Board, hold the button down until the gate reaches the fully intended closed position.
4. Adjust the Closed Limit Switch on the operator until the RED light illuminates on the front of the control board as shown above. The fully CLOSED limit switch is now set.

8 - LEARNING MODE

Apollo has taken great care to simplify the installation, operation and safety of this device and to ensure longevity and reliability of the unit over time. The learning procedure consists of the following steps shown below:

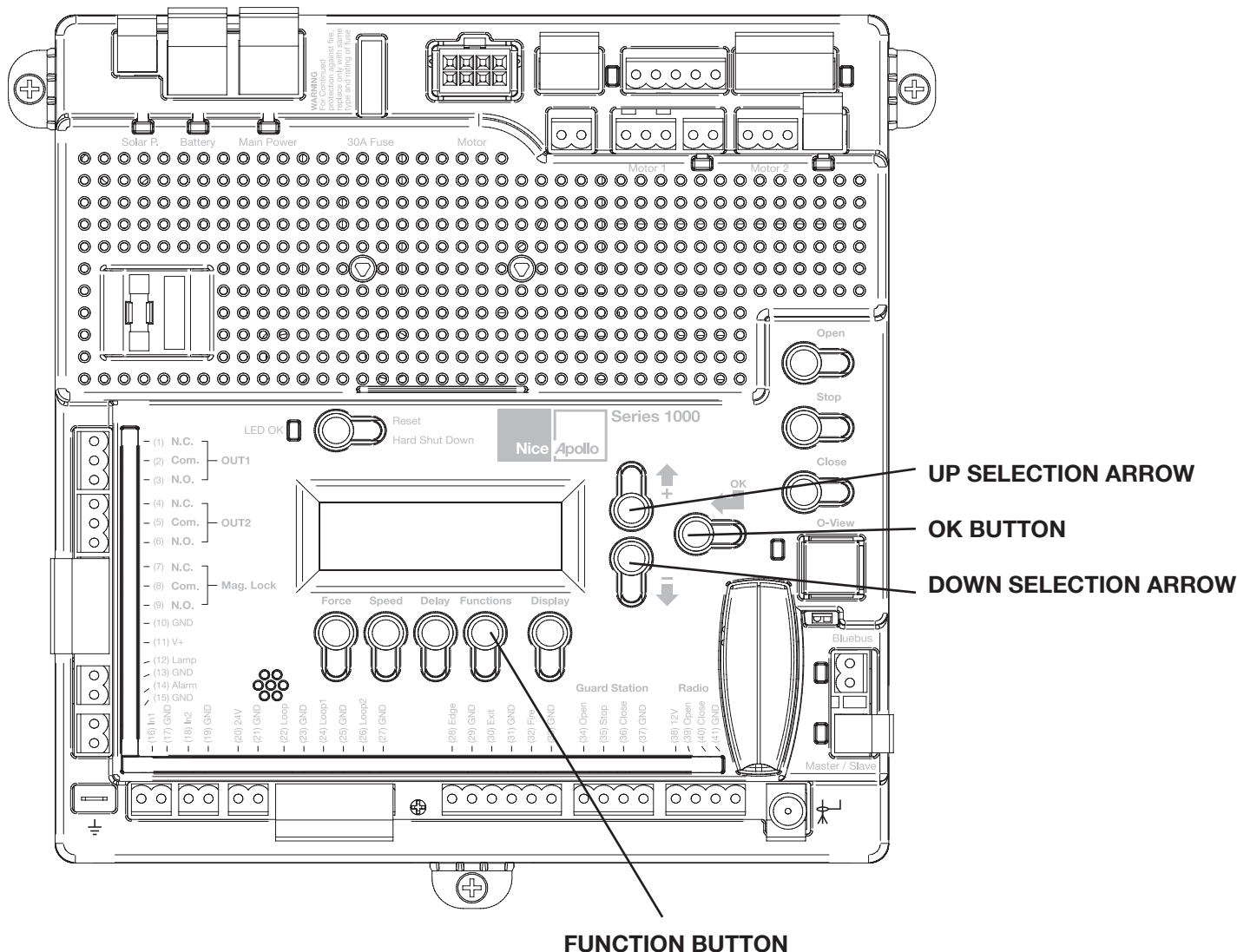

NOTE: The control board is already in the “LEARNING MODE” when shipped.

If not in learning mode:

1. Press FUNCTION then press OK.
 2. Using the arrow buttons select SWING or SLIDE then press OK.
 3. Select LIGHT, AVERAGE OR HEAVY, then press OK
1. Test the motor direction by pressing and holding CLOSE. If the gate instead OPENS swap the RED and BLACK motor leads and retest to verify correct operation. Set limits according to the operators installation manual.
 2. Press and hold the Open or Close button on the gate controller until the gate is 50% open.
 3. Press ENTER to allow the control board to scan for attached items, such as sensors, photo-eyes and other safety devices and start the learning sequence. The gate will open partially then stop. This is being done, so that the control board can sense the type and operational condition of the drive motor. The gate will then run to the closing limit (one leaf at a time in case of dual application: “slave” closes first then “master” follows), so that it can properly sense the close limit switch. The gate will then fully open to test the open limit switch then fully close at high speed. The gate should be fully learned by the control board at this point.

The gate opener is now programmed for basic usage.

9 - ACCESSORY INPUTS AND OUTPUTS

9.1 - Outputs

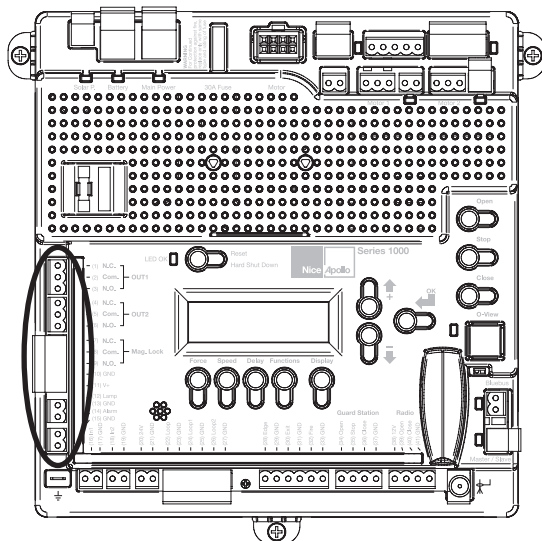

Figure - BOARD OUTPUTS

GATE OPERATOR ACCESSORY OUTPUTS:

OUT1 and OUT2: Individual, isolated relays provide COMMON, NORMALLY OPEN, and NORMALLY CLOSED dry contacts for switching accessories based on programming of the "Auxiliary IO" function. These outputs are programmed in the "FUNCTION Auxiliary I/O" menu.

Magnetic Lock: Provides fused power (1.85A max) and isolated relay COMMON, NORMALLY OPEN, and NORMALLY CLOSED dry contacts for electrically powered and maintained magnetic locks. The output time for magnetic lock activation/deactivation may be adjusted from 0 to 5 seconds.

Lamp: Provides fused power (1.85A max) to drive a flashing warning lamp to indicate gate operation. This output is active when the gate is operating (Opening and Closing). Lamp Delay sets the amount of time the lamp accessory output is activated prior to gate movement. Settings from 0 to 5 seconds with a step of 0.5 seconds.

Alarm: Provides fused power (0.5A @ 12VDC) to drive an alarm siren to signal the occurrence of a hard shutdown, caused by 2 consecutive entrapment events (signals). This alarm output is reset by pressing the "Reset Hard Shutdown" button on the front panel or activating the "FIRE" input.

9.2 - Inputs

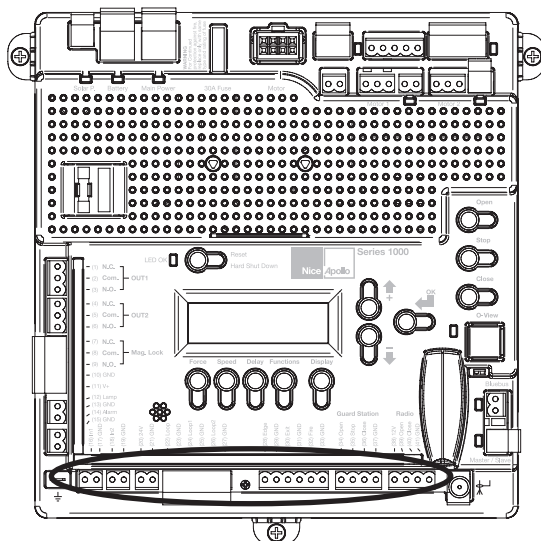

Figure - INPUTS

GATE OPERATOR ACCESSORY INPUTS:

Auxiliary Inputs 1 (16) and 2 (18): These digital inputs may be connected to the digital outputs of accessories and programmed to activate or control the gate operator in a number of different modes. Shorting the pins through a dry contact activates the programmed settings for these inputs. These inputs are programmed in the "FUNCTION Auxiliary I/O" menu.

SAFETY LOOP Input: (22) Dry contact input that can be programmed for an inductive safety loop or photo-eye detector. Shorting pin 22 to GND reverses a closing gate to the full open position. The opened gate is held opened for as long as the LOOP input is active.

SHADOW (LOOP 1) Input: (24) Dry contact input that can be programmed for an inductive safety loop or photo-eye detector. Shorting the LOOP 1 input (24) to GND maintains an OPEN gate fully open and a CLOSED gate fully closed until deactivated.

Setting the LOOP1 input to "Photo Mode" causes the moving gate to stop, then reopens the gate when the LOOP1 input is deactivated.

ENTRAPMENT (LOOP 2) Input: (26) Dry contact input that can be programmed for an inductive safety loop or photo-eye detector. Shorting the LOOP2 input (26) to GND while the gate is opening cause the gate to close to the fully closed position. This loop input is intended for use with safety sensors to prevent entrapment between the opening gate and an adjacent wall or structure.

Edge Input: (28) This input may be configured as "DIGITAL" or "ANALOG" as required by the sensor type. When configured as "DIGITAL", this is a dry contact input; otherwise when configured as "ANALOG", the input must measure 8200ohms. When the input is activated it stops the gate regardless of direction of travel, momentarily reverses it then stops.

Exit Input: (30) Dry contact input for a vehicle exit sensor. Shorting this input to GND opens gate from the closed position and holds gate open with maintained input or reverses gate if closing.

Fire Input: (32) Dry contact input for a fire department control switch. Opens the gate and holds the gate open until the control switch is deactivated. This input is "hold to run". Auto-close is disabled when this input is activated. Also clears hard shutdown.

GUARD STATION

Guard Station Open: (34) Dry contact input for a guard station open switch. Momentarily shorting the digital input to GND opens the gate to the full open position with the subsequent auto-close feature enabled.

Guard Station Stop: (35) Dry contact input (Normally Closed) for a guard station stop switch. Momentarily opening this input stops the opening gate at its current position. While this input is activated, all other inputs are disabled and are not functional.

Guard Station Close: (36) Dry contact input for a guard station close switch. Momentarily shorting the digital input to GND closes the gate (master and slave).

RADIO

Radio Open: (39) Dry contact input for an accessory radio open switch. Momentarily shorting the digital input to GND opens the gate to the full open position with the subsequent auto-close feature enabled.

Radio Close: (40) Dry contact input for an accessory radio close switch. Momentarily shorting the digital input to GND closes the gate.

Radio Input: Open/Close: (39 and 40) If you tie open and close together the unit will operate as a Step by Step command each time the input is shorted to GND, it will either OPEN, STOP or CLOSE.

9.3 - Communication buses

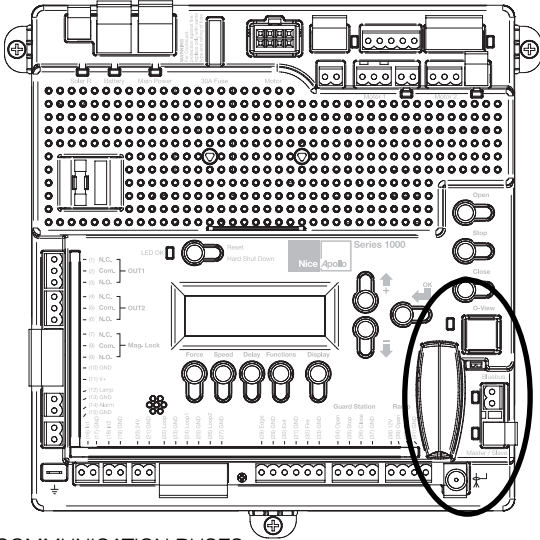

Figure - COMMUNICATION BUSES

OVERVIEW

Programming and diagnostic unit which connects directly to the gate controller and is part of the Nice "Opera" control system. The unit can be used in "stand-alone" mode via its front-panel keypad, or it may be accessed via Bluetooth or cellular-enabled PDA, PC, or Smartphone when used with the O-View Software Suite. This unit, when matched with the OVIEW Bluetooth or GSM modules, enables remote control and management of the gate controller. Remote control functions include most of the programming functions that are available at the front panel LCD on the control board as well as software updates.

OVBT: Bluetooth module for OVIEW and the "O-View Software Suite" application for PC, PDA, or Smartphone for localized wireless control of the gate controller.

OVBTGSM: Combination GSM and Bluetooth module that plugs into the OVIEW and provides cellular phone access through the "O-View Software Suite" application for PC, PDA, or Smartphone, for wireless local, national, and international control of the gate controller.

O-VIEW Software Suite: Provides desktop or Smartphone level control of the gate controller. Other benefits include software updates that can be made as new versions of software are made available.

BLUEBUS ACCESSORIES

MOTB: Moon Touch programmable keypad with secure codes (up to 9 digits per code if required) to control gate opening and closing. Connects to the 2-wire BlueBUS connector with inexpensive unshielded twisted-pair wire.

MOFB: Photocell transmitter and receiver pair that connects to the 2-wire BlueBUS connector with inexpensive unshielded twisted-pair wire and is a non-contact sensor for entrapment protection as specified in UL325, Section 31.1 "General Entrapment Protection Provisions".

MASTER/SLAVE - Intended for 24V commercial operators only

The gate operator includes a two-pin connector designed to link two separate gate operators together as a Master/Slave pair. The Master/Slave configuration is enabled by connecting two gate operators with simple, unshielded twisted-pair wire (Max. 100 ft.). All entrapment sensors, switch inputs, receiver controls, and outputs must be wired to the gate operator designated as the "Master". The following procedure outlines the process for configuring the Master/Slave pair.

Perform the "Learn" process to configure open and close limits with the gate for each operator. See the "Programming Quick Start" procedures in this manual for a description of the gate learning process.

On the Master operator, select Function -> Adv. Settings -> Remote Mst. Slv. Then select On -> Master. The red LED associated with the Master/Slave connector will illuminate.

On the Slave operator, select Function -> Adv. Settings -> Remote Mst. Slv. Then select On -> Slave. The red LED associated with the Master/Slave connector will illuminate.

The Master/Slave pair is now configured. The Slave gate operator will perform identical open/close/stop functions in tandem with the Master gate operator.

9.4 - Programming the plug-in receiver and remote controls

Nice Plug-In Receiver: The Nice 433Plug-In Receiver provides up to 15 channels for specific control of individual gate functions. The receiver includes built-in programming functions for adding or removing Nice wireless remote controls to/from a gate installation. The following procedures detail the steps to assign a remote control, add a new remote control, delete a single remote control, or remove all remote controls from the receiver memory.

Programming the Nice 2-Button or 4-Button Remote Control with the Nice Plug-In Receiver.

These procedures apply to the Nice wireless remote control. These procedures assign factory default controls automatically to the remote control.

1. Have a functioning Nice 2-button or 4-button remote control with a battery installed prior to programming the remote control.
2. Press and hold the button on the side of the Nice receiver until the led illuminates green on the Nice receiver, then release the button.
3. Within 10 seconds, press and hold any key on the Nice remote control until the led in the Nice receiver blinks green 3 times, indicating that the Nice is programmed to control the receiver.
4. After the led on the Nice receiver blinks green 3 times, another 10 second interval is started to program another Nice remote control if desired. Repeat step 3 to program the additional Nice remote control. Step 3 may be repeated as many times as necessary to program all available Nice remote controls.
5. Verify that the Nice remote control(s) can control the gate by pressing one or more buttons individually on the remote control(s).

Add new remote control to the Nice Plug-In Receiver

A Nice remote control that has been programmed to control a Nice receiver may be used to create other Nice remote controls for the same receiver. This procedure needs to be performed within 10 to 20m (30 to 60 feet) of the Nice receiver, but the Nice receiver does not need to be physically accessed.

1. Press and hold any button on the non programmed Nice remote control for at least 5 seconds, then release the button, taking note of the button that was pressed.
2. Press the same button on the programmed Nice remote control three times.
3. Press the same button in step 1 on the non programmed Nice remote control and release.
4. It is recommended to test the new copy of the Nice remote control with the assigned gate controller.

NOTE: This procedure will affect all Nice receivers within radio range.

Deleting a Single Nice Remote Control from the Nice Plug-In Receiver Memory

A Nice remote control that has been programmed to control a Nice receiver may be removed from the Nice receiver memory without affecting other assigned remote controls. This procedure needs to be performed at the Nice Plug-In Receiver with the affected Nice remote control.

1. Press and hold the button on the side of the Nice receiver until the led on the Nice receiver illuminates green and keep the button pressed. The led will illuminate after approximately 4 seconds.
2. Press and hold any button on the Nice remote control until the led on the Nice receiver blinks 5 green flashes
3. Release the button on the side of the Nice receiver.
4. It is recommended to verify that the de-programmed Nice remote control no longer controls the gate.

Deleting all Nice transmitters from the Nice Plug-In Receiver Memory.

All programmed remote controls may be removed from the Nice plug in receiver memory . This procedures need to be performed at the gate controller.

1. Press and hold the button on the side of the Nice receiver until the led on the Nice receiver illuminates green and keep the button pressed.
2. Watch the led and on the receiver and verify the following sequence in the led.
3. Within 4 seconds after pressing the button (approx.) the green led illuminates.
4. Within 8 seconds after pressing the button (approx.) the green led turns off.
5. With 12 second after pressing the button (approx.) the green led starts flashing
6. Count the green led flashes on the Nice receiver. On EXACTLY the 3rd flash, release the button on the Nice receiver.
7. It is recommended to test the Nice remote controls, if available, with Nice plug in receiver to verify that it no longer affects the gate controller.

10 - 120VAC POWER AND SOLAR CHART

10.1 - 120VAC POWER

DO NOT WIRE AC POWER TO THE 1050 CONTROL BOARD!

THE CONTROL BOARD OPERATES ON 10 - 35 VDC ONLY!

This section intended for commercial operators where 120VAC power supply is present or for residential systems where a 120VAC transformer will be used

Use only U.L. listed (or equivalent) non-contact sensors. Inputs from the photo-beam to the circuit board are Normally Open (N.O.). Use only U.L. listed (or equivalent) non-contact sensors.

Connect the non-contact sensors. Inputs from the photo-beam to the circuit board are Normally Open (N.O.). Photo-beam input shall REVERSE travel of gate when activated during the CLOSE CYCLE ONLY. Gate will resume normal operation when photo-beam is no longer activated. To reduce the risk of SEVERE INJURY or DEATH:

- Disconnect power to the gate operator by manually opening its dedicated circuit breaker before making any mechanical or electrical adjustments.
- Use a 20 Amp dedicated circuit breaker for each installed gate operator.
- Open dedicated circuit breaker supplying power to this gate operator BEFORE a new installation or making any modifications to an existing installation of this gate operator.
- All wiring connections MUST be made by a qualified individual
- Run individual circuits in separate U.L. listed conduits. Do not combine high voltage (120VAC) power wiring and low voltage (+12VDC to +24VDC) control wiring in the same conduits.
- Use the information in table 1 to determine high voltage wire size requirements. The distance shown in the chart is measured in feet from the operator to the power source. If power wiring is greater than the maximum distance shown, it is recommended that a service feeder be installed. When large gauge wire is used, a separate junction box must be installed for the operator connection. The wire table is based on stranded copper wire. Wire run calculations are based on a 110 VAC power source with a 3% voltage drop on the power line, plus an additional 10% reduction in distance to allow for other losses in the system.

Table 1 - MAXIMUM RUN (FT) PER WIRE GAUGE

110V AWG	14	12	10	8	6	4
MAX RUN (ft)	180	280	460	700	1150	1800

The gate operator system should be grounded through the earth ground in the AC mains wiring system (GREEN WIRE). This ground connection will prevent dangerous currents from appearing on the metal control box, the actuator, or the gate itself.

DO NOT WIRE AC MAINS POWER TO THE METAL CONTROL BOX WITHOUT AN EARTH GROUND CONNECTION!



10.2 - SOLAR PANEL CHART

The following table should be used as a guide for capacity of operation of operators only, additional options and accessories may reduce the daily usage.

Please note that the charge capability of solar panels will vary with different geographical locations.

Daily cycles	1-10	1-20	1-40	1-60	1-80	80+
5 watt solar panel	*					
10 watt solar panel		*				
20 watt solar panel (requires regulator)			*			
30 watt solar panel (requires regulator)				*		
40 watt solar panel (requires regulator)					*	
1.5 amp battery charger					*	
10 amp battery charger						*

**Note: Double the amount of solar wattage for dual gate operators
Double the amount of panels for a 24VDC system**

Nice Apollo operators with the 1050 board that are used in solar applications need to be put into "Standby" mode.

To do this, press Functions – scroll to #8 "Standby" – Press OK – Scroll to desired amount of time before system enters Standby mode – Press OK. Once this is done, the operator will enter a Standby mode after the set time when the operator is not moving or in the auto-close countdown.

Things to note in Standby:

1. Display will be off and only a "heartbeat" will be present at the LED OK
2. Voltage at #20 (24 volts) and #38 (12 volts) will turn off. **DO NOT POWER ENTRY OR EXIT DEVICES HERE**
3. BluBus connection is non functional
4. Master/Slave synching is non functional (used for commercial operators only)

Connection of the solar panel(s) may be made at the top left corner of the board at "Solar P" (regulated charging to the "Battery" via the controller in the board) – note that the maximum output of the regulator in the 1050 board is 1.5A. If the installation requires larger than a 30W solar panel – an off-board regulator should be used and connected directly to the battery.

Estimating solar panel requirements:

Cycles per day / 2 = Watts of power

Accessory current Draw X 24 / 300 = Watts of power

Add these two values together to determine the total solar wattage necessary for your system (12 volt applications)

For 24 volt applications, you will need TWO 12VDC panels of this wattage tied in series or one 24VDC panel at double the wattage.

11 - OPTIONAL INPUTS

11.1 - Fire dept. connection

32 FIRE
33 GND

Dry contact input for a fire department control switch. Normally Open (NO) contact must be shorted to ground through a switch to open the gate. The FAIL SAFE connector which is shorted at the factory with a jumper (Normally Closed NC), may be wired in parallel with the Fire input to release the motor in the event of an emergency entry by the fire department during a power failure. Opening the FAIL SAFE contacts allows the gate to be pushed open by hand.

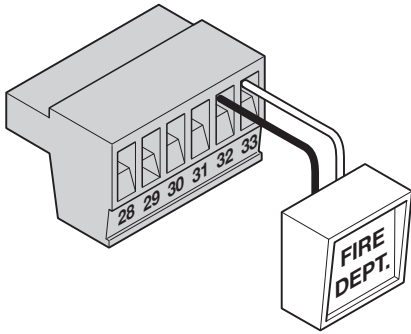

Figure - FIRE DEPT. INPUT

11.2 - Magnetic lock connection

7 NC
8 Com (Common)
9 NO
10 GND
11 V+ (Voltage is determined by incoming power supply)

This connection is used to install the magnetic lock. In this instance a gate can be locked magnetically to prevent a forced opening. Consult lock manual for specifics on installation and wiring

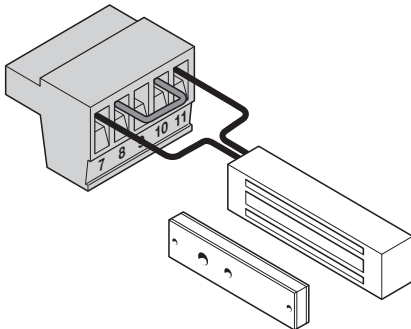

Figure - MAGNETIC LOCK WIRING (EXAMPLE)

11.3 - Guard station

34 OPEN
35 STOP
36 CLOSE
37 GND

With the Guard Station switches installed, the user can operate the gate by pushing the respective buttons for the command that is desired. Gate Open and Close are controlled by NORMALLY OPEN (NO) and Stop is controlled by NORMALLY CLOSED (NC) momentary switches.

NOTE: If the guard station inputs are not used STOP (35) and GND (37) need to be tied together

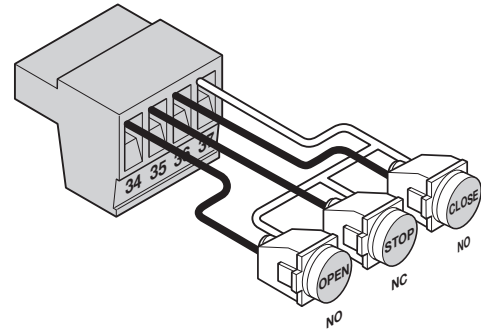

Figure - GUARD STATION INPUTS

11.4 - Exit and edge inputs wiring diagram

28 EDGE
29 GND
30 EXIT
31 GND

The EDGE input may be configured as a monitored ANALOG input, or DIGITAL (NC or NO) input. The EDGE sensor input is intended for ANSI/UL 325 listed gate edge sensors to protect against entrapment and hazardous pinch points along the moving edge of the closing gate. The EXIT sensor input is provided to activate to open the gate, or re-open a closing gate, upon sensing an exiting vehicle.

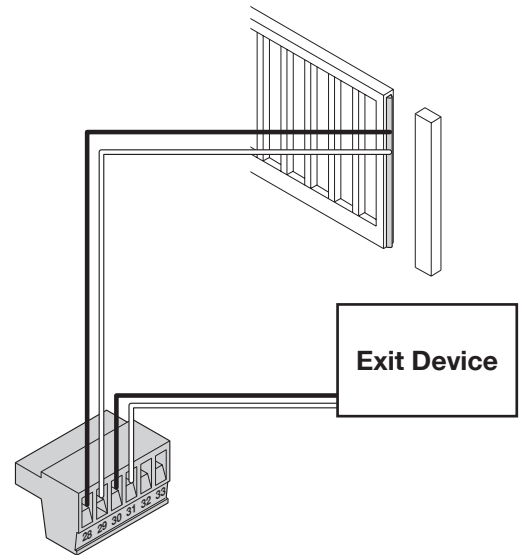

Figure - EXIT AND EDGE INPUTS

11.5 - Radio receiver connection (third party)

38 12V
39 OPEN
40 CLOSE
41 GND

The customer supplied radio receiver allows the gate operator to be operated via remote, such as wireless key-card readers or user remote controls.

Connecting the Open (39) and Close (40) pins together with the relay of a receiver enables step by step gate control. This configuration allows a single button to control the gate in the following sequence:

Press - Gate Open
Press - Gate Stop
Press - Gate Close
Press - Gate Stop

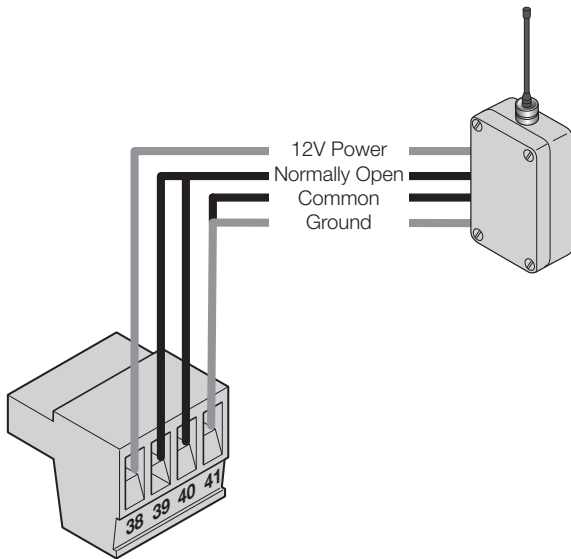

Figure - RADIO RECEIVER

11.6 - Optional power output

10 GND
11 V+

When the control board is in standby mode, power is still present at terminals 10 and 11. If standby mode is to be used (especially in a solar application) You may use the terminals 10 and 11 to provide power to accessories. Please note that the output voltage of terminal 11 is the same as the highest incoming voltage (on battery OR main power) to the control board.

For example:

If you are using a 12VDC battery to power to the control board connected to the Battery input, and the voltage of the battery is 13.5VDC - terminal 11 will have a 13.5VDC output.

If you are using a power supply input of 32VDC to the control board connected to the Main Power input - terminal 11 will have a 32VDC output.

If you are using a power supply connected to Main Power (at 32VDC) and also using a battery connected to the Battery input (at 13.5VDC) - terminal 11 will have an output of 32VDC.

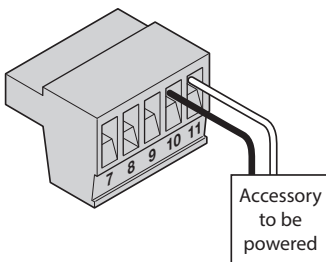

Proper inspection of all equipment is required to ensure continuous functionality, safety and to ensure reliable operation in all weather conditions. Inspect electrical assemblies and wiring installations for damage, general condition, and proper functioning to ensure the continued satisfactory operation of the electrical system. Adjust, repair, overhaul, and test electrical equipment and systems in accordance with the recommendations and procedures in the gate operator system and/or component manufacturer's maintenance instructions.

Replace components of the electrical system that are damaged or defective with identical parts, with manufacturer's approved equipment, or its equivalent to the original in operating characteristics, mechanical strength, and environmental specifications. A partial list of suggested problems to look for and checks to be performed are listed below:

- 12.1** Damaged, discolored, or overheated equipment, connections, wiring, bearing caps and installations.
- 12.2** Excessive heat or discoloration at high current carrying connections. (look for bluing or heat affected metal).
- 12.3** Misalignment of electrically driven equipment. (Causes strain on pulley assemblies and bearings).
- 12.4** Poor electrical bonding (broken, disconnected or corroded bonding strap) and grounding, including evidence of corrosion.
- 12.5** Dirty equipment and connections. Clean equipment and connections.
- 12.6** Improper, broken, inadequately supported equipment, wiring and conduit, loose connections of terminals, and loose ferrules.
- 12.7** Poor mechanical or weld joints. Broken welds.
- 12.8** Condition of circuit breaker and fuses. Ensure that they are of the correct type and amperage.
- 12.9** Insufficient clearance between exposed current carrying parts and ground or poor insulation of exposed terminals. All exposed connections must be covered (prevent arcing between exposed parts, and electrical shock).
- 12.10** Broken or missing wire, connectors, etc.
- 12.11** Operational check of electrically operated equipment such as motors, inverters, generators, batteries, lights, protective devices, etc. Ensure proper functionality of all systems during inspections.
- 12.12** Ensure safety placards and warning signs are present as specified within this document. Ensure proper functionality of all safety devices as specified. Non-functioning or malfunctioning safety devices should be replaced immediately.

13 - GENERAL LAYOUT AND SAFETY ACCESS

13.1 -Swing Gate

Entrapment Protection Inputs - Typical Installation Diagram Utilizing Loop Sensors and Photocells

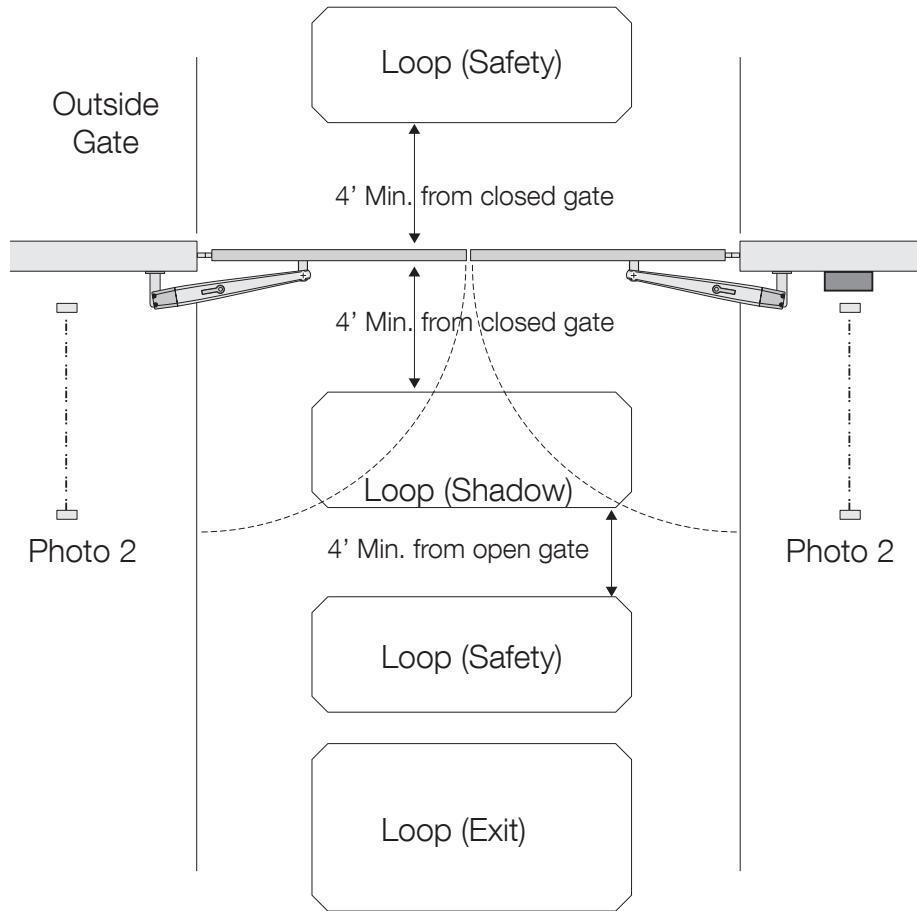

Figure - LAYOUT FOR IN-GROUND LOOPS

Entrapment Protection Inputs - Typical Installation Diagram Utilizing Photocells

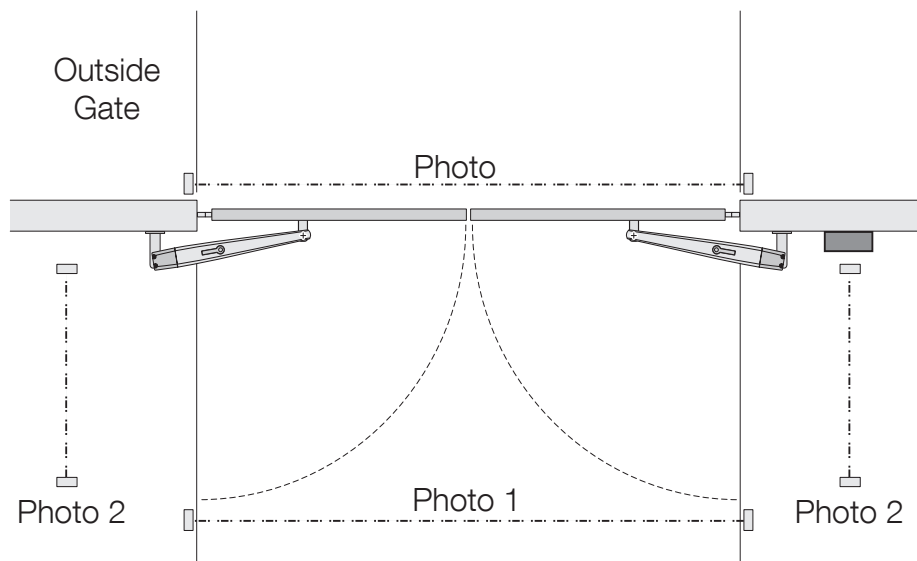

Figure - LAYOUT FOR PHOTOCELLS

13 - GENERAL LAYOUT AND SAFETY ACCESS

13.2 -Slide Gate

Entrapment Protection Inputs - Typical Installation Diagram Utilizing Loop Sensors and Photocells

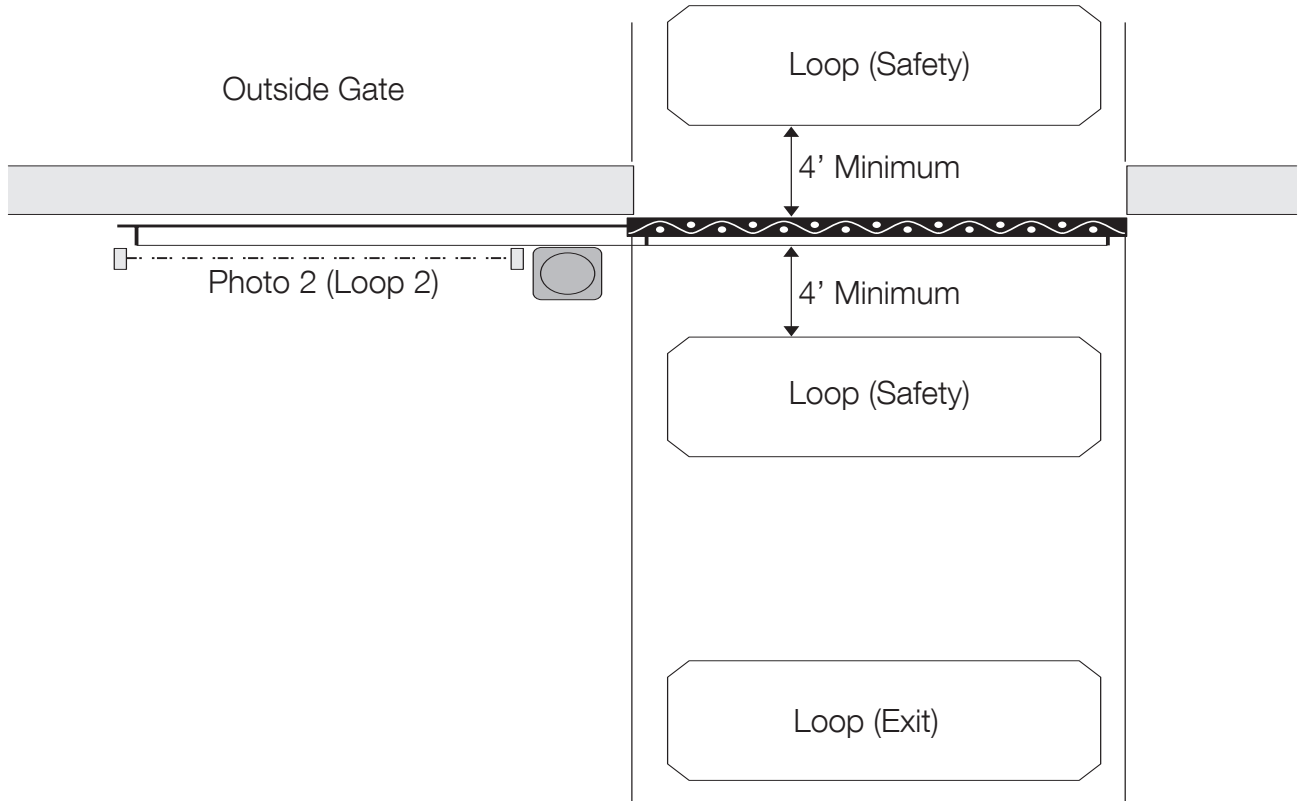

Figure - LAYOUT FOR IN-GROUND LOOPS

Entrapment Protection Inputs - Typical Installation Diagram Utilizing Photocells

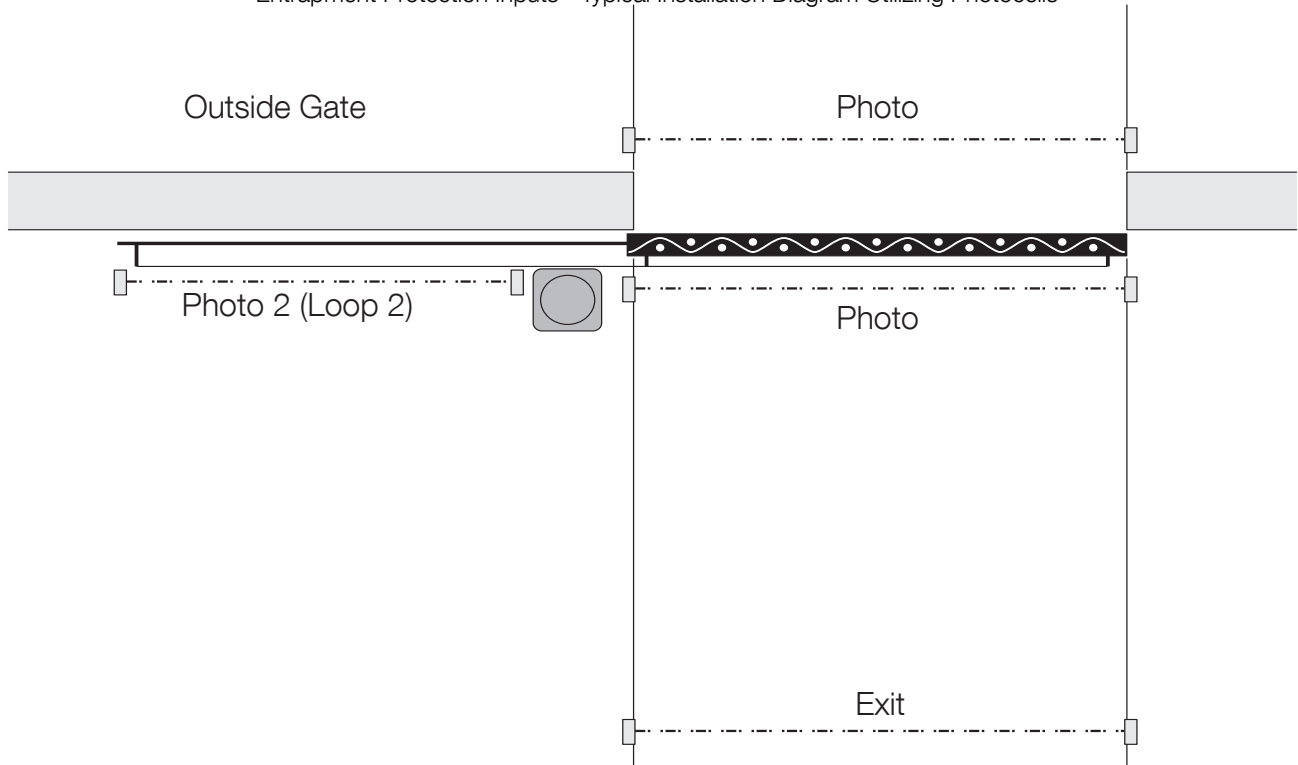

Figure - LAYOUT FOR PHOTO EYES

14 - ACCESSORIES AND SENSORS

EXTERNAL ENTRAPMENT PROTECTION

Non-contact and contact sensors must be installed individually or in combination with each other to provide external entrapment protection.

Care should be exercised to reduce the risk of nuisance tripping, such as when a vehicle trips the sensor while the gate is still moving, and one or more non-contact sensors shall be located where the risk of entrapment or obstruction exists, such as the perimeter reachable by a moving gate or barrier.

A hardwired contact sensor shall be located and its wiring arranged so that the communication between the sensor and the gate operator is not subjected to mechanical damage.

A wireless contact sensor such as one that transmits radio frequency (RF) signals to the gate operator for entrapment protection functions shall be located where the transmission of the signals are not obstructed or impeded by building structures, natural landscaping or similar obstruction.

DURING INSTALLATION

- DISCONNECT POWER at the control panel before making any electric service power connection.
- Be aware of all moving parts and avoid close proximity to any pinch points.
- Know how to operate the manual release.
- Adjust the unit to use the minimum force required to operate the gate smoothly even during mid-travel reversing.
- Place controls a minimum of 8 feet away from the gate so that the user can see the gate and operate controls but cannot touch the gate or gate operator while operating the controls.
- Warning signs must be placed on each side of the gate or in high-visibility areas to alert of automatic gate operations.



15 - BOARD NOMENCLATURE

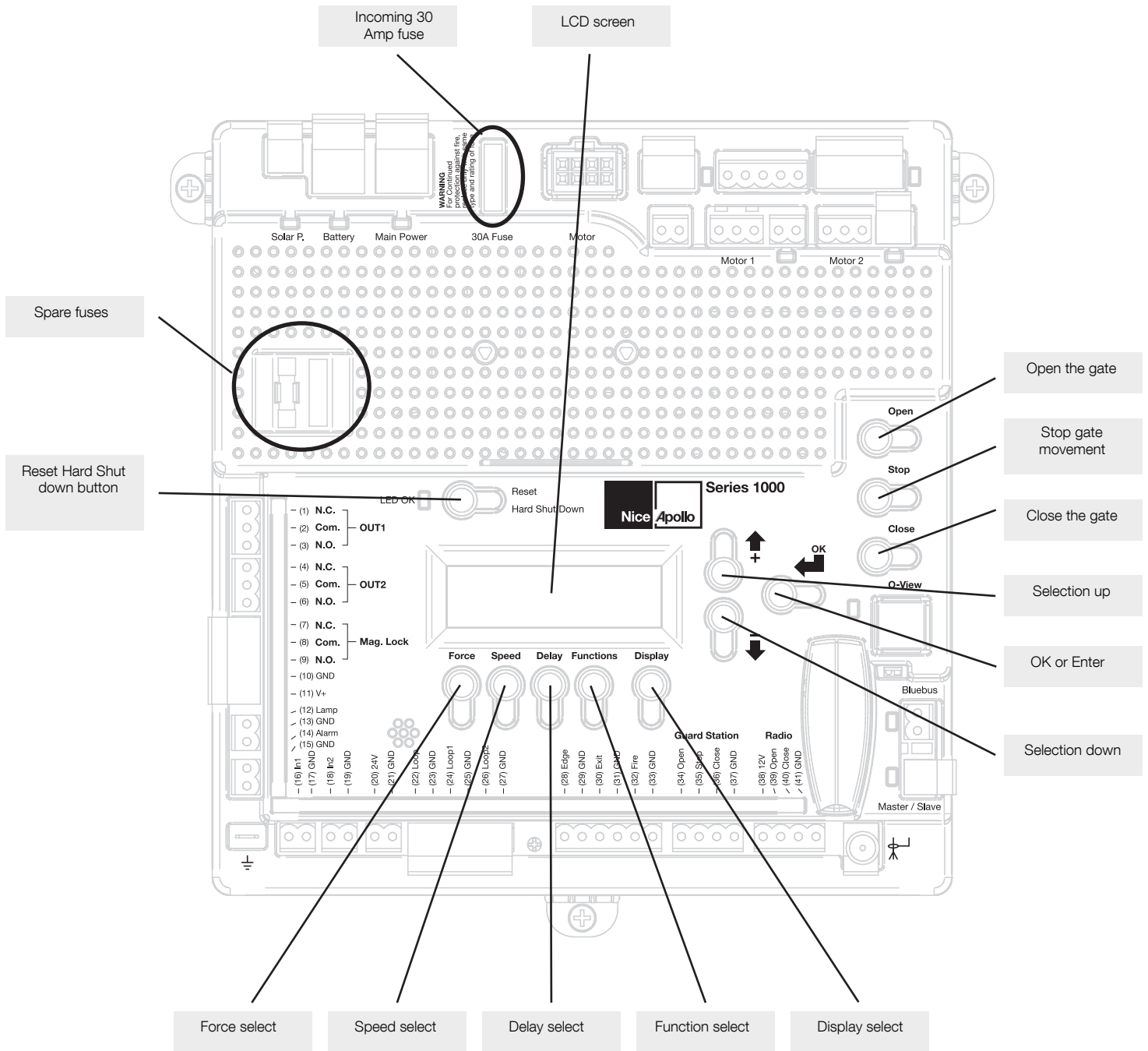

Figure - GENERAL BOARD OVERVIEW

THE PROGRAMMING BUTTONS INDICATED IN THE ABOVE REFERENCE SHOULD BE USED ONLY AFTER UNDERSTANDING THE MANUAL AND ITS RELATION TO THE PROGRAMMING SEQUENCES SHOWN ON THE FOLLOWING PAGES. CARE SHOULD BE TAKEN WHENEVER CHANGES ARE IMPLEMENTED TO ENSURE PROPER FUNCTIONALITY AND SAFETY.

16 - PROGRAMMING BUTTONS

16.1 - Force

Static: Set sensitivity to constant force on a scale of 1 to 10 (1 being the most sensitive).

Dynamic: Set sensitivity of sudden impact force to the moving gate on a scale of 1 to 10 (1 being most sensitive).

ESC: Exit the FORCE menu.

16.2 - Speed

Max: Sets the limit of maximum allowed gate speed on a scale of 20% to 100% (20% being the lowest setting).

Standard: Sets the limit of the gate speed during normal movement (not soft start/stop) on a scale of 20% to MAX (20% being the lowest setting).

Low: Sets the limit of the gate speed while in LEARNING mode and when moving in SLOW, on a scale of 20% to 100% (20% being the lowest setting).

Slowdown: Set gate speed when going into approaching the open or close limits on a scale of 20% to 100% (20% being the lowest setting).

16.3 - Acceleration

Max: Sets the limit of gate acceleration when reversing the gate after an obstacle has been detected by the UL/Edge or current sense feature (Force). Settings from 3 to 10, with 10 being the highest rate of gate acceleration. *

Standard: Sets the limit of the gate acceleration in normal operation. Settings from 1 to MAX, with MAX being the highest rate of gate acceleration. * *TO PREVENT DAMAGE TO THE GATE OR THE CONTROLLER USE LOWER ACCELERATION SETTINGS FOR HEAVIER GATES.

ESC: Exit the SPEED menu.

16.4 - Delay

Auto Close: Sets the timeout before the gate closes automatically from the fully open position. Settings from 0 (off) to 90 seconds. Setting this to 0 will disable the auto close timer.

Slave: Sets the delay for opening the slave gate leaf in a Master/Slave (Motor 1 and Motor 2 operation), (dual gate) system. Settings from 0 to 5 seconds with a step of 0.5 seconds.

Lamp/Strobe: Sets the amount of time the Lamp accessory output is activated prior to gate movement. Settings from 0 to 5 seconds with a step of 0.5 seconds.

Lock: Sets the amount of time the Magnetic Lock accessory output is activated to disable the lock when opening the gate. Settings from 0 to 5 seconds with a step of 0.5 seconds.

Run Time: Sets the maximum run time for the gate. Used in case the gate doesn't reach its limits. Settings from 15 to 120 seconds with a step of 1 second.

ESC: Exit the DELAY menu.

16.5 - Function

Learn: Puts the gate operator into learning mode for a Swing or Slide gate, and Blue BUS peripherals. Learning mode for a Swing or Slide style gate involves selecting the gate type (Light, Average, Heavy), then fully opening and closing the gate to sense the limits. Selecting the gate type selects pre-calculated values for the FORCE, SPEED, and ACCELERATION settings. Learning the Blue BUS peripherals enables the gate operator to discover and integrate accessory devices like Blue BUS access control and safety devices.

Positions: Configures the points in the gate open, close, and partial cycles at which deceleration occurs.

- Slow Down – Open: Sets the point in the % of gate opening when the gate begins deceleration to the fully open position.

- Slow Down – Close: Sets the % of gate opening when the gate begins deceleration to the fully close position.
- Partial: Sets the point in the % of gate opening when the gate begins when given a PARTIAL command.

Auxiliary Inputs: Auxiliary inputs IN AUX1 (16) and IN AUX2 (18) can be programmed with one of the following options:

- No program No Function used
- OPEN the Gate
- CLOSE the Gate
- STEP Cycling Step (Open-Stop-Close-Stop)
- PARTIAL opening
- PARTIAL 1 Partial Opening 1 (open one leaf in dual gate applications)
- STOP the gate and Auto-closing
- HOLD TO OPEN Input must be maintain active for Opening
- HOLD TO CLOSE Input must be maintain active for Closing
- FIRE Reset Hard Shut Down and Open the Gate
- TIMER 1 Start Count Down TIMER1
- TIMER 2 Start Count Down TIMER2
- PHOTO Photocell PHOTO input: reverse to opening when closing
- PHOTO1 Photocell PHOTO1 input: Stop Gate when activated
- PHOTO2 Photocell PHOTO2 input: reverse to closing when opening
- SHADOW Loop input: prevent closing gate when completely open
- LOCK system from other command (only STEP H overrides the lock)
- UNLOCK Unlock the system if locked
- OPEN and LOCK Open the Gate and inhibit further commands (except STEP H)
- CLOSE and LOCK Close the Gate and inhibit further commands (except STEP H)
- OPEN and UNLOCK Open the Gate and un-inhibit further commands
- CLOSE and UNLOCK Close the Gate and un-inhibit further commands
- STEP H Command high priority Step cycling (open-stop-close-stop)

Auxiliary Outputs: Auxiliary outputs OUT AUX1 (1,2,3,) and OUT AUX2 (4,5,6,) can be programmed with one of the following options:

- NO PROGRAM Output not used
- OPEN Output is activated when Gate is open
- CLOSE Output is activated when Gate is closed
- MOVING Output is activated when Gate is moving
- TIMER 1 Output is activated when TIMER1 is counting down
- TIMER 2 Output is activated when TIMER2 is counting down

Radio Channel: For the Plug-in On board Receiver, 15 radio channels may be programmed with one of the following options:

- NO PROGRAM
- OPEN (Default CH. 2)
- CLOSE
- STEP (Default CH. 1)
- PARTIAL
- PARTIAL 1
- STOP
- HOLD TO OPEN
- HOLD TO CLOSE
- TIMER 1
- TIMER 2
- PHOTO
- LOCK
- UNLOCK
- OPEN and LOCK
- CLOSE and LOCK
- OPEN and UNLOCK
- CLOSE and UNLOCK
- STEP H
- TOGGLE & LATCH

Timers: Set time for count down timers Timer 1 and Timer 2. Settings between 1 second and 9 hours in 1 second increments.

Events: Up to 8 weekly events (EV1 through EV8) can be programmed and stored. Each event can be programmed to trigger at a specific time and can

be assigned to any combination of days of the week (Monday through Sunday). Events that are already programmed into the system may be suspended temporarily, or removed permanently from memory. The following actions can be assigned to events:

- No program
- Open
- Close
- Partial
- Partial1
- AxOut1 On
- AxOut1 Off
- AxOut2 On
- AxOut2 Off
- Open and Lock
- Close and Lock
- Open and Unlock
- Close and Unlock
- Timer 1
- Timer 2

To program weekly events EV1 through EV8, perform the following steps:

1. Press FUNCTION -> Events.
2. Press and hold OK to display EV1 (display will blink "EV1").
3. Press UP or DOWN to toggle between events, then press OK to make a selection. The display changes to hours.
4. Press UP or DOWN to toggle between hours, then press OK to make a selection. The display changes to minutes.
5. Press UP or DOWN to toggle between minutes, then press OK to make a selection. The display changes to individual days of the week.
6. Press UP or DOWN to toggle between days of the week. Press OK to toggle between ON and OFF for each day of the week. Continue toggling through the days of the week until ESC is displayed. Press OK to advance to the next event.
7. Repeat step 2 through 6 for event EV2 through EV8.

To temporarily suspend one or more weekly events (EV1 through EV8), perform the following steps:

1. Press FUNCTION -> Events.
2. Press OK quickly to display EV1 active days.
3. Press OK quickly again to display "Suspend". Event EV1 is now suspended and will not run until re-enabled.
4. Press UP or DOWN to toggle through the events EV1 – EV8 and repeat steps 2 through 3 to suspend or enable other weekly events.

Charger: A battery charger is built-in with the Control board for use with a backup battery. The charger may be manually programmed for customized charge settings or set to "Auto" to provide a battery charging profile that automatically compensates for temperature and current during the charging process. The following parameters are available for programming the battery charger:

- Charger On/Off
- Select Max current for charging (from 0.1A to 1.5A step 0.05A)
- Cycling Time (1 second off charging every cycling time)
- Auto (best charge considering temperature)

Standby: Programs the timeout for the gate operator to go into low power standby mode. Low power standby is Settings from 5 to 120 seconds, or may be disabled with "OFF". During low power standby there is no data displayed on the gate operator LCD and it consumes a minimum amount of power to extend the life of the backup battery. All the outputs are switched off and the LED OK blinks to show this standby status of the system.

Advance Settings: The following settings are available for customizing the gate operator as required by the customer's installation requirements:

- Set Language (English Spanish French)
- Set clock 12H/24H
- Set LCD Contrast
- Direction Motor (Changes main motor direction) (Can only be performed in learn mode)
- Auto Close Option (Allows auto close timer to close from any open position)
- Exit Option (Disables free exit input when partially open)

- Set Anti-tailgate (Closes gate immediately after vehicle has cleared safety sensors)
- Select inputs LOOP or PHOTO
- Select UL/EDGE input type (NO, NC, Analog)
- Select Master / Slave Motor1 or Motor2
- Activate link for remote Master/Slave (Enables control of an additional gate operator board)
- Power Fail Open (Opens gate automatically on batter backup power if main AC power input loss is detected)
- Motor 12V (Forces motor control voltage to +12VDC even if the supply voltage varies from +9.5VDC up to +35VDC)
- Set Virtual Encoder (Used for motors without built-in encoders)

Default: This setting gives the installer/user the option of returning some or all settings of the gate operator to the original factory settings:

- System settings
- Radio Channel settings
- Event settings
- Charger settings

ESC: Exit the FUNCTION menu.

16.6 - Display

ESC: Exit the DISPLAY menu.

Info: Displays the manufacturer name, product name/model, software versions, and serial number.

Clock: Displays the calendar date and time in the real time clock. Pressing and holding the "OK" button for 5 seconds enables the date and time settings to be updated manually.

Main Volt: Displays the gate operator main control voltage in volts DC.

Battery Volt: Displays the gate operator backup battery voltage in volts DC.

Sun Volt: Displays the solar panel input voltage in volts DC.

Motor Volt: Displays the voltage at the motor in volts DC.

UL Volt: Displays the voltage at the UL/Edge sensor input in volts DC.

Temperature: Displays the temperature of the gate controller board in degrees Centigrade or Fahrenheit (press OK and hold 5 seconds to change scale).

Service: The following information is recorded and viewable about the operating history of the gate:

- Total: Displays the total number of open-close cycles (non- Settings).
- Partial: Display the total number of partial cycles. Reset by pressing the "OK" button for several seconds.
- Maint. Display the number of cycles before service is required. Settings from 1000 to 50000 cycles in increments of 1000 cycles.

Motor: Displays the Motor position, voltage, and current.

Motor 1: Displays the Motor1 position, voltage, and current.

Motor 2: Displays the Motor2 position, voltage, and current.

Charger: Displays the battery charger voltage and current.

Last Reset: Displays the code for diagnostic review. Used for diagnostic and troubleshooting.

ESC: Exit the DISPLAY menu.

17 - EMERGENCY VEHICLE ACCESS

- 17.1** The automatic vehicular gate system must be designed to allow access to emergency vehicles under different operating conditions.
- 17.2** During normal powered operation, emergency vehicles access the gate by use of the emergency vehicle access device installed on your gate system. The type of device that is used in your community is dependent on your city codes. These devices may include (but are not limited to) Fire Department lock boxes, Click-2-Enter radio receivers, strobe light sensors, siren sensors, etc.
- 17.3** Check with your installer to determine if your gate system is equipped with a back-up power system. In the event of a primary (AC) power failure and a back-up system (DC) power failure (low charged or dead batteries for example), the system must have a release system to allow the gate to be manually operated. The release device must be accessible from either side of the gate and must be present so that emergency personnel can gain access through the gate under this condition.
- 17.4** If applicable, this system is equipped with a manual release system that will allow the gate to be pushed open in the event of a power outage or equipment failure.
- 17.5** NOTE: Never attempt to manually push open any gate with an operator attached to it until you have verified that power to the operator has been shut-off.
- 17.6** The automatic vehicular gate system must be designed to allow access to emergency vehicles under different operating conditions.
- 17.7** In the event of a power failure, the emergency vehicle access device may not be functional because the gate operator is not powered. NOTE: DC powered back-up systems are optional and your gate system may or may not be equipped with one. Check with your installer to determine if your gate system is equipped with a back-up power system.
- 17.8** For manual fail-safe gate operation, turn power to the operator OFF. If a backup power system is in use, be sure that this power is turned OFF also or disconnected. Once power is OFF, the gate can be manually operated, by using the MANUAL RELEASE handle under the key lock (T5X1K/T7X1K), using the supplied key and turning the release lever (H12), using the supplied key and disengaging the release mechanism (M12), removing the cover and disengaging the manual release mechanism (7200/7300), or disconnecting the gate attachment bracket (416X1K/816X1K).

18 - GLOSSARY

LOCK - Ceases all operator function except HIGH PRIORITY inputs.

COMMERCIAL / GENERAL ACCESS VEHICULAR GATE OPERATOR-CLASS II - A vehicular gate operator (or system) intended for use in a commercial location or building such as a multi-family housing unit (five or more single family units), hotels, garages, retail store, or other building servicing the general public.

ENTRAPMENT - The condition when an object is caught or held in a position that increases the risk of injury.

FORCE STATIC - Constant load threshold for sensitivity setting.

FORCE DYNAMIC - Impact sensitivity setting.

GATE - A moving barrier such as a swinging, sliding, raising, lowering, or the like, barrier, that is a stand-alone passage barrier or is that portion of a wall or fence system that controls entrance and/or egress by persons or vehicles and completes the perimeter of a defined area.

(STEP H) HIGH PRIORITY - Step by step control.

INHERENT ENTRAPMENT SENSOR SYSTEM - An automatic sensor system which senses entrapment of a solid object and is incorporated as a permanent and integral part of the operator.

INDUSTRIAL / LIMITED ACCESS VEHICULAR GATE OPERATOR-CLASS III - A vehicular gate operator (or system) intended for use in an industrial location or building such as a factory or loading dock area or other locations not intended to service the general public.

RESTRICTED ACCESS VEHICULAR GATE OPERATOR-CLASS IV - A vehicular gate operator (or system) intended for use in a guarded industrial location or building such as an airport security area or other restricted access locations not servicing the general public, in which unauthorized access is prevented via supervision by security personnel.

RESIDENTIAL VEHICULAR GATE OPERATOR-CLASS I - A vehicular gate operator (or system) intended for use in a home of one-to four single family dwelling, or garage or parking area associated therewith.

STEP BY STEP - Command that opens-stops-closes-stops the gate with each press of the button.

SYSTEM - In the context of these requirements, a system refers to a group of interacting devices intended to perform a common function.

UNLOCK - Resumes normal operation after a blocked condition.

WIRED CONTROL - A control implemented in a form of fixed physical interconnections between the control, the associated devices, and an operator to perform predetermined functions in response to input signals.

WIRELESS CONTROL - A control implemented in means other than fixed physical interconnections (such as radio waves or infrared beams) between the control, the associated devices, and an operator to perform predetermined functions in response to input signals.

19 - MAINTENANCE SCHEDULE

Table 2

		COMPLETE	BASIC
Alarm	Active the primary (inherent) reverse system by blocking the gate with a solid object. The gate should reverse momentarily then stop. Restart the gate and block again with a solid object. The gate should reverse momentarily, then stop, and go into hard shutdown with an alarm	●	●
Backup System	If operator is equipped with option DC backup system, check to be sure the system opens the gate upon loss of AC power	●	●
Battery	If operator is equipped with option DC backup system, check the batteries for any leakage or loose connections. Batteries should be replaced every two years	●	
Fire Dept	Check emergency vehicle access device for proper operation	●	●
Gate	Inspect for damage	●	
Reverse System	Check that the gate reverses on contact with an object in both the opening and closing cycles	●	●
Loop(s)	Check vehicular reverse and shadow loops for proper operation	●	●
Release	Check manual release for proper operation	●	
Complete	Overall Check: Complete check of gate and gate operating system	●	
Mounting Hardware	Check screws and nuts	●	

20 - TROUBLESHOOTING

Table 3

SYMPTOM(S)	POSSIBLE SOLUTION
Operator will not Power On. Power LED is OFF	Check that power to the circuit board is turned ON Check terminal block wiring for loose or broken wires If voltage measures OK, check the terminal block Check the fuses (may be both AC and DC fuses in installation)
Gate opens a short distance, then stops and reverses	Check the UL/Edge input on the gate controller Adjust Force Settings
Gate opens but will not close	Check the input LEDs. Any ON will hold the gate open and indicates a problem with a keying device Check the secondary safety devices. Any activated safety devices will hold the gate open and indicates a problem with the safety device Check the loop detectors. Any activated safety devices can hold the gate open and indicates a problem with the loop detector or ground loop
Battery backup system will not open gate upon AC power outage	Check if backup system is set to open gate automatically or requires an input to open Check the batteries for proper voltage. Replace if necessary
Hard Shutdown (2 back to back obstructions) LED blinking, Buzzer sounds for 5 minutes	Clear any obstructions from the path of the gate. Press RESET to clear (or hard reset button)
Gate opens by itself	Check accessory inputs and clear then as necessary

21 - INSTALLATION CHECKLIST

Left box is for installer check off and the right box is for customer check off.

- 1. The gate has been checked to make sure it is level and moves freely in both directions.
- 2. Potential pinch areas have been guarded so as to be inaccessible OR have contact and/or non-contact obstruction sensing devices installed.
- 3. The installer has installed one or more contact or non-contact obstruction sensing devices, in compliance with UL325 requirements for this installation.
- 4. If pedestrian traffic is expected, a separate pedestrian gate has been installed, a minimum of seven feet from the gate. The customer has been informed that all pedestrian traffic must use the pedestrian gate.
- 5. Warning signs have been installed on each side of the gate in highly visible locations. The customer has been informed that these signs must remain at all times.
- 6. There are no controls installed on the gate operator, or within 8 feet of the gate.
- 7. The installer has properly adjusted the obstruction sensing feature and has tested the gate to make sure that the gate stops and reverses a short distance with minimal resistance applied (Approximately 40 lbs. on a swing gate, at the end of the gate).
- 8. The installer has instructed the customer in the proper use of the gate operator and reviewed all of the operational functions, obstruction sensing devices, warning beeper and reset, etc.
- 9. The installer has instructed the customer in the proper use of the operator's manual disconnect feature. The manual disconnect must never be used while the gate is in motion. The power switch must be turned off before using the manual disconnect and disengaging the operator.
- 10. The installer has reviewed all safety instructions with the customer, and has left the safety instructions and owner's manual for their reference.
- 11. The installer has answered any questions the customer has regarding the operation of the gate operator and gate operator safety precautions.
- 12. The installer has explained to the customer that a regular maintenance schedule for both the gate and the gate operator is recommended.

Installation Acceptance

Address where opener is located

Installer name, number and address

End user name and telephone number